



This is a digital copy of a book that was preserved for generations on library shelves before it was carefully scanned by Google as part of a project to make the world's books discoverable online.

It has survived long enough for the copyright to expire and the book to enter the public domain. A public domain book is one that was never subject to copyright or whose legal copyright term has expired. Whether a book is in the public domain may vary country to country. Public domain books are our gateways to the past, representing a wealth of history, culture and knowledge that's often difficult to discover.

Marks, notations and other marginalia present in the original volume will appear in this file - a reminder of this book's long journey from the publisher to a library and finally to you.

Usage guidelines

Google is proud to partner with libraries to digitize public domain materials and make them widely accessible. Public domain books belong to the public and we are merely their custodians. Nevertheless, this work is expensive, so in order to keep providing this resource, we have taken steps to prevent abuse by commercial parties, including placing technical restrictions on automated querying.

We also ask that you:

- + *Make non-commercial use of the files* We designed Google Book Search for use by individuals, and we request that you use these files for personal, non-commercial purposes.
- + *Refrain from automated querying* Do not send automated queries of any sort to Google's system: If you are conducting research on machine translation, optical character recognition or other areas where access to a large amount of text is helpful, please contact us. We encourage the use of public domain materials for these purposes and may be able to help.
- + *Maintain attribution* The Google "watermark" you see on each file is essential for informing people about this project and helping them find additional materials through Google Book Search. Please do not remove it.
- + *Keep it legal* Whatever your use, remember that you are responsible for ensuring that what you are doing is legal. Do not assume that just because we believe a book is in the public domain for users in the United States, that the work is also in the public domain for users in other countries. Whether a book is still in copyright varies from country to country, and we can't offer guidance on whether any specific use of any specific book is allowed. Please do not assume that a book's appearance in Google Book Search means it can be used in any manner anywhere in the world. Copyright infringement liability can be quite severe.

About Google Book Search

Google's mission is to organize the world's information and to make it universally accessible and useful. Google Book Search helps readers discover the world's books while helping authors and publishers reach new audiences. You can search through the full text of this book on the web at <http://books.google.com/>

INSTRUCTION
FOR
FIELD ARTILLERY.

INSTRUCTION

FOR

FIELD ARTILLERY.

PREPARED BY A BOARD

OF

ARTILLERY OFFICERS.

PHILADELPHIA:
J. B. LIPPINCOTT & CO.
1861.

Entered, according to act of Congress, in the year 1860, by

J. B. LIPPINCOTT & CO.

In the Clerk's Office of the District Court of the United States in and for
the Eastern District of Pennsylvania.

BALTIMORE, Md., *January 15, 1859.*

Colonel S. COOPER,

Adj. Gen. U. S. A.

SIR: The Light Artillery Board, assembled by Special Orders No. 134 of 1856, and Special Orders No. 116 of 1858, has the honor to submit a revised system of Light Artillery Tactics, and regulations recommended for that arm.

WM. H. FRENCH, *Bt. Major,*

Capt. First Artillery.

WILLIAM F. BARRY,

Capt. Second Artillery.

HENRY J. HUNT, *Bt. Major,*

Capt. Second Artillery.



WAR DEPARTMENT, *March 6, 1860.*

The system of instruction for Field Artillery, prepared by a Board of Light Artillery officers pursuant to orders from this Department, having been approved by the PRESIDENT, is herewith published for the information and government of the Army.

All exercises, manœuvres, and forms of parade not embraced in this system, are prohibited in the Light Artillery, and those herein prescribed will be strictly observed.

JOHN B. FLOYD,

Secretary of War.

(v)

EXTRACT.



“AN ACT to establish an uniform mode of discipline and field exercise for the militia of the United States.

“SECTION 1. That the system of discipline and field exercise, which is and shall be ordered to be observed by the regular Army of the United States, in the different corps of infantry, artillery, and riflemen, shall also be observed by the militia, in the exercise and discipline of the said corps, respectively, throughout the United States.”

APPROVED, May 12, 1820.

(vi)

TABLE OF CONTENTS.

PART I.

ORGANIZATION, MATERIEL, AND SERVICE.

PLATES		PAGE
	ARTICLE I.—ARTILLERY AND ITS DUTIES.....	1
	Artillery troops and their service	1
	Uses and objects of field artillery.....	2
	Materiel, pieces.....	2
	Carriages.....	3
	Battery of manoeuvre.....	3
	Number of horses required for each carriage.....	3
	Personnel.....	4
	Proportion of field artillery to other arms.....	4
	ARTICLE II.—ORGANIZATION AND EQUIPMENT OF FIELD BATTERIES.....	5
	Organization for instruction.....	5
	Organization for the march	5
	Organization for war.....	5
	Composition and equipment of battery for war.....	7
	Field pieces. Description.....	8
	Field pieces. Principal dimensions and weight.....	9
	AMMUNITION. <i>Gunpowder</i> . Composition	9
	Density.....	10
	Proof.....	10
	Charges	11
	Cartridge bags.....	11

(vii)

PLATES		PAGE
1	PROJECTILES. Kinds of.....	11
	Solid shot.....	11
	Canisters.....	11
	Shells.....	12
	Charges of shells.....	12
	Shrapnell or spherical case shot.....	12
	Charges of Shrapnell.....	13
1	FUZE. Description.....	13
	Operation of.....	14
	Primer.....	14
	Description.....	14
	Issues of ammunition to batteries.....	14
	Care and preservation of ammunition.....	14
	Weights of fixed ammunition.....	15
	Contents and weights of packing boxes.....	15
8 to 17	FIELD CARRIAGES. Number and kinds of gun carriages..	16
	Caissons.....	16
	Battery wagons.....	16
	Travelling forges.....	16
	Limber for field carriages.....	16
	Wheels.....	16
2	<i>Ammunition chests</i>	17
	Ammunition carried in each chest.....	19
	Method of packing ammunition chests.....	21
	Implements and equipments for a gun carriage.....	21
	Implements and equipments for a caisson.....	21
	Weights of gun carriages and caissons equipped.....	22
	Equipment of the travelling forge.....	23
	Equipment of the battery wagon.....	27
	Supply of spare parts.....	33
	Composition and preparation of paints.....	33
	Quantity of paint required for a carriage.....	34
	Paint for tarpaulins.....	34
	Weights of forges and battery wagons equipped.....	35
	HORSES. Number required for a field battery.....	35
	Spare horses for prairie service.....	36
	For cannonneers of horse artillery.....	36
	<i>Horse equipments.</i> Number of sets required.....	36
	<i>Artillery harness.</i> Description and peculiarities.....	36
	Harness required for each horse.....	37

TABLE OF CONTENTS.

ix

PLATES

	PAGE
ARTICLE III.—POINTING AND RANGES.....	38
Definitions.....	38
Theory of pointing.....	39
Pendulum hausse.....	40
Seat for pendulum hausse.	40
Muzzle sight.....	40
Practical hints on pointing	41
Causes which disturb the true flight of projectiles.....	41
Rapidity of fire at advancing bodies.....	42
Table of ranges for field service	43
ARTICLE IV.—INTERIOR ECONOMY OF A BATTERY.....	46
<i>Artillery horses.</i> Description.....	46
Working power.....	47
Forage.....	47
Necessity of grain ration	47
Water	48
General rules for stable management.....	48
Grooming.....	50
ARTICLE V.—FIELD SERVICE.....	52
Marches.....	52
Ascents.....	55
Descents.....	56
To cross swampy ground	56
To pass a ditch.....	57
Crossing fords.....	57
Passage of military bridges.....	58
Passage on ice.....	59
Reversing a battery in a narrow road	59
Instruction for the preservation of harness.....	60
Transport of batteries by sea.....	61
Preparation of transports.....	61
To embark the horses	61
To embark the battery.....	62
To disembark	62
In action or preparing for action.....	63
Replacing killed or disabled horses.....	65
Order of encampment.....	65

PART II.

TACTICAL INSTRUCTION.

PLATES		PAGE
	Basis of instruction.....	67
	Composition of the company.....	67
	Formation of the company.....	68
	Posts of the officers, non-commissioned officers, etc.....	69
	The battery	71
	General principles	72
28 and 29	The battery of manœuvre. Composition of.....	75
	Definitions.....	76
25 and 26	Elementary movements, and their objects.....	76
	Method of giving commands	78
81 to 88	Bugle or trumpet signals and calls.....	78

PART III.

SCHOOL OF THE PIECE.

	NOS.	PAGE
ARTICLE I.—METHOD OF INSTRUCTION	1	79
The cannoneer dismounted.....	2	80
Elementary instruction.....	2	80
Position of the cannoneer dismounted.....	3	80
Eyes right—eyes left	4	80
Facing.....	5	80
Marching.....	8	81
To halt.....	9	82
To march backwards.....	10	82
To mark time when marching	11	82
To change step	12	82
To face when marching.....	13	83
Manual of the sabre.....	18	84
Inspection of sabre.....	23	85
Parade rest	26	86
ARTICLE II.—THE GUN DETACHMENT.....	28	87
Forming and telling off the detachment.....	30	87
To form in one rank.....	32	88

TABLE OF CONTENTS.

xi

PLATES

	NOS.	PAGE
Alignments.....	33	88
Direct march in single file.....	36	89
Change of direction in file.....	39	90
Oblique march in file.....	40	90
Direct march in line.....	41	90
To halt the detachment.....	42	90
Wheelings.....	43	91
“ in circle.....	44	91
“ to the right or left.....	45	91
The reverse.....	46	92
To move forward.....	47	92
To form the detachment in two ranks.....	48	92
To march by a flank.....	51	93
Marching by a flank, to form line.....	53	94
Oblique in line.....	54	94
To march to the rear.....	55	95
To march backwards.....	56	95
To open and close the ranks.....	57, 58	96
Execution of the movements at double quick...	61	96
The platoon.....	62	97
Sabre exercise.....	63	97
To open files.....	65	98
To close files.....	92	106
ARTICLE III.—MANUAL OF THE PIECE.....	93	107
Method of instruction.....	93	107
Posts of the cannoneers, piece unlimbered.....	95	107
Loading and firing.....	96	108
Loading by detail.....	110	117
Moving the piece by hand, piece unlimbered....	111	118
Changing posts.....	113	118
Equipments.....	114	119
Limbering.....	115	119
Posts of the cannoneers, piece limbered.....	118	120
To form the detachment.....	119	121
Posts of the detachment.....	120	121
Change of posts of detachment.....	121	121
To post the cannoneers at the piece limbered.....	123	123
Moving the piece by hand, piece limbered.....	124	123
Unlimbering and coming into action.....	126	124
Service of the gun with diminished numbers.....	129	124
Supply of ammunition in action.....	131	126

PLATES		NOS.	PAGE
	ARTICLE IV.—MECHANICAL MANGEVRES		127
	<i>Nomenclature</i>		127
6 and 7	The gun	132	127
8 and 9	The carriage	132	128
10 and 11	The limber	132	129
12 and 13	The caisson	132	129
	Changing ammunition chests	134	131
	Changing wheels	135	132
	Dismounting pieces	136	134
	Mounting pieces	137	135
	Carrying pieces	138	136
	Dismounting carriages	139	137
	Mounting carriages	140	138
	Righting carriages that have been overturned..	141	138
	Spiking and unspiking cannon and rendering them unserviceable	142	139
	ARTICLE V.—THE CANNONEER MOUNTED		141
	General remarks	143	141
	Elementary instruction	146	142
	To bridle the horse	147	142
	To saddle	148	142
	To lead out	149	143
	Position before mounting	150	144
	To mount	151	144
	Exercise at a halt	153	145
	Position of the cannoneer mounted	153	145
	Eyes right—eyes left	154	145
	To lengthen the snaffle rein	155	145
	To shorten the snaffle rein	156	146
	To cross the reins in one hand	157	146
	To take the reins in both hands	158	146
	Use of the bridle reins and legs	159	146
	Effect of the reins and legs	160	147
	To march	161	147
	To halt	162	148
	To turn to the right or left	163	148
	To reverse to the right or left	164	148
	To oblique	165	149
	To rein back	166	149
	To dismount	169	150
	To file off	170	151

TABLE OF CONTENTS.

xiii

PLATES		NOS.	PAGE
	To unsaddle	171	151
	To unbridle.....	172	151
	Vaulting, the horse unsaddled.....	173	152
	Marching.....		152
	<i>Riding-house drill</i>	174	152
19, Fig. 1	To march to the right or left hand.....	175	152
	To halt and to move off.....	176	153
	To trot, and to resume the walk.....	177	153
19, Fig. 2	Changes of hand	178	154
	To cross reins in marching	179	154
20, Fig. 1	To turn by cannoneer in marching.....	180	155
20, Fig. 2	Marching on the same line, to reverse by cannoneer.....	181	155
	Marching in column, to reverse by cannoneer	182	156
	To rest.....	184	156
	To rest in marching.....	185	156
	Vaulting, the horses saddled	186	156
	The spur.....	187	157
19, Fig. 3	To mount in two ranks	188	157
19, Fig. 4	To conduct the cannoneers to the riding-house...	190	158
20, Fig. 3	Change of direction in the length of the riding-house.....	194	159
21, Fig. 1	Change of direction obliquely by cannoneer.....	195	160
21, Fig. 2	To march in a circle.....	197	160
21, Fig. 3	To change hand on the circle.....	198	161
21, Fig. 4	To reunite the cannoneers	199	161
21, Fig. 5	To form the cannoneers in line	200	162
19, Fig. 3	To dismount in two ranks.....	201	162
	Exercise with the stirrups.....	202	162
20, Fig. 1	To turn to the right or left by cannoneer.....	203	163
20, Fig. 2	The reverse by cannoneer	204	163
	To pass from the head to the rear of the column..	205	163
	From a halt to move at a trot.....	206	163
	To pass from the trot to the trot out, and to resume the trot.....	207	164
	To pass from the trot to the gallop.....	208	164
	To passage to the right or left	209	165
	The curb bridle.....	212	166
	Position of the bridle hand.....	213	166
	Movements of the bridle hand.....	214	167
	Principles of the gallop.....	217	168
	Exercise at a gallop.....	218	169

PLATES		NOS.	PAGE
	Manual of the sabre.....	221	170
	Sabre exercise.....	227	172
	To leap the ditch and the bar.....	228	172
	ARTICLE VI.—THE DETACHMENT—<i>Horse Artillery</i>...		174
	Forming and telling off the detachment.....	231	174
22	To mount and dismount in two ranks.....	232	174
	To form in one rank.....	234	175
	Alignments.....	235	175
	To form in two ranks.....	241	177
	To open and to close the ranks.....	242	178
	To rein back the detachment.....	244	178
22	To march the detachment by file.....	245	179
	Direct march in file.....	248	180
	Change of direction in file.....	249	180
	To halt and to move off.....	250	180
	Oblique in file.....	251	180
	To break into single file.....	253	181
	To form in double files.....	255	182
	To form the detachment in line.....	256	182
	Direct march in line.....	260	183
	Wheeling.....	268	186
	Wheel in circle in single rank.....	269	187
	Wheel in circle in two ranks.....	272	188
	Wheel to the right or left.....	275	189
	Half-wheel to the right or left.....	276	189
	Reverse to the right or left.....	277	190
	Oblique in line.....	279	190
	Changes of gait.....	281	191
	The platoon.....	283	191
	ARTICLE VII.—THE DRIVER.....	284	193
18	Nomenclature of the harness.....	285	193
	To harness.....	286	194
	To couple.....	288	195
	To mount.....	289	195
	Use of the coupling rein and whip.....	290	196
	To march.....	292	196
	To turn to the right and to the left.....	294	197
	To reverse.....	296	197
	To oblique.....	297	197
	To rein back.....	298	198

TABLE OF CONTENTS.

XV

PLATES		NOS.	PAGE
	To dismount	299	198
	To file off.....	300	198
	To unharness.....	301	199
	To harness and unharness in two motions.....	304-5	200
	Marching.....	306	200
23, Fig. 1	To break into column to the front.....	307	200
	Change of direction in column.....	308	201
	To halt the column.....	309	201
	To oblique in column.....	310	201
	To form line	311	202
	To advance in line.....	314	203
	To oblique in line.....	315	203
	To march to a flank.....	316	203
	To reverse in marching.....	317	204
	Changes of gait.....	318	204
	To pass from the rear to the head of the column and the reverse.....	320	205

PART IV.

SCHOOL OF THE SECTION.

<i>General Principles</i>	322	206
ARTICLE I.—EXERCISE OF SEVERAL DETACHMENTS...		207
Formation of detachments and posts of officers...	323	207
Alignment	325	208
To open and close the ranks.....	326	208
To break into column to the right or left.....	327	208
March in column	328	208
To halt the column.....	330	209
Change of direction in column.....	331	209
To march by a flank when in column.....	332	209
Oblique march in column.....	334	210
Being in column, to form line.....	335	210
To form line advancing	340	212
To advance in line.....	341	212
Oblique in line.....	342	213
To change direction in line.....	343	213
To march by a flank when in line.....	344	213
To change direction when faced by a flank.....	347	214

PLATES		NOS.	PAGE
	Marching by a flank to form column of detachments	348	214
	To pass from the march in column to the march by flank	349	214
	Marching by flank to form line.....	350	214
	To form the line or column faced in the opposite direction.....	351	215
	To march to the rear.....	352	215
	Posting the detachments with their pieces.....	353	215
	Execution of the movements at the double quick..	354	216
	Exercise of the section and of the company.....	355	216
ARTICLE II.—EXERCISE OF SEVERAL DETACHMENTS.			
	<i>Horse Artillery</i>		217
	Formation of detachments and posts of officers... 22	356	217
	To mount and to dismount.....	359	217
	Alignments	360	218
	To open and close the ranks.....	361	218
	To break into column.....	362	218
	March in column	365	219
	To halt the column.....	366	219
	Change of direction in column.....	367	219
	Oblique march in column.....	368	220
	The column marching, to face it in the opposite direction.....	369	220
	Being in column, to form line	370	221
	To form line advancing.....	374	222
	To advance in line	375	223
	Oblique in line	376	223
	To change direction in line.....	377	223
	Marching in line, to march in the opposite direction	378	224
	To march by file.....	379	224
	Change of direction in file.....	380	224
	To halt and to move off.....	381	224
	Oblique in file.....	382	224
	Changes of gait.....	383	225
	To break into single file	384	225
	To form double files.....	385	225
	To form line	386	225
	Marching by a flank, to form column of detachments	388	225

TABLE OF CONTENTS.

xvii

PLATES		NOS.	PAGE
	In column of detachments, to march by file.....	389	226
	Posting the detachments with their pieces.....	390	226
	ARTICLE III.—EXERCISE OF SEVERAL PIECES.....		227
	The team.....	391	227
	Arrangement of the teams.....	392	227
23, figs. 1, 2	To break into column.....	393	228
	To change direction in column.....	394	229
	To halt the column.....	395	229
	Oblique in column.....	396	229
	To form line.....	397	230
	To form line advancing.....	401	231
	To advance in line.....	402	231
	To halt.....	403	232
	To march by a flank.....	405	232
	Oblique in line.....	406	233
	To reverse.....	407	233
	Changes of gait.....	408	233
	To rest.....	409	233
	To file off.....	410	234
	The piece horsed.....	411	234
23, Fig. 3	To enter the park.....	412	234
	Hitching the teams.....	413	235
23, Fig. 4	To unpark.....	415	236
	To halt the column.....	416	237
23, Fig. 5 } 25	To wheel.....	417	238
23, Fig. 6 } 25	To oblique.....	418	238
23, Fig. 7	To reverse.....	419	238
23, Fig. 8	The about.....	420	239
	To change direction in column.....	422	240
	The about in column.....	423	240
	Changes of gait.....	424	240
	To march by a flank.....	425	241
	To rest.....	428	241
	To resume the exercise.....	429	242
	To rein back.....	430	242
	To dismount whilst marching.....	431	243
	To mount whilst marching.....	432	243
	To park.....	433	243
	To unhitch.....	434	244
	To leave the park.....	435	245

PLATES		NOS.	PAGE
	ARTICLE IV.—THE SECTION.....		247
	Composition of the section.....	436	247
	Column of pieces.....	437	247
28	Order in line.....	438	247
29	Order in battery.....	439	248
	Posts of officers and non-commissioned officers....	440	248
	Alignments.....	441	249
	Posts of the cannoneers during the manœuvres...	444	250
	To mount and dismount the cannoneers.....	445	250
	To unpark.....	449	252
30	To form the section.....	450	252
	To march and to halt.....	451	253
	Changes of gait.....	452	254
35	To change direction.....	453	254
31	To march by a flank.....	454	255
33 and 34	The oblique.....	455	256
	The reverse.....	456	257
	The about.....	457	257
	The countermarch.....	458	258
25	Passage of carriages.....	460	259
30	To break the section.....	461	260
	To form the caissons on the flank.....	462	261
	To replace the caissons in rear.....	463	261
	To form the park.....	464	262
	<i>Formation in battery</i>		262
52	In line, with pieces in front, to form in battery to the front.....	465	262
	In line, to form in battery to the front, by throwing the caissons to the rear.....	466	264
52	In line, with caissons in front, to form in bat- tery to the front.....	467	264
53	In line, with pieces in front, to form in battery to the rear.....	468	265
53	In line, with caissons in front, to form in bat- tery to the rear.....	469	265
54	In battery, to form in line to the front.....	470	266
55	In battery, to form in line to the rear.....	472	267
66 and 67	To march by a flank.....	473	268
	Movements with the prolonge.....	476	270
71	<i>Firings</i>	477	272
71	To fire to the rear.....	478	273

PART V.

SCHOOL OF THE BATTERY.

PLATES		NOS.	PAGE
	ARTICLE I.—GENERAL PRINCIPLES.....		274
24, 25, 26 } 27, 28, 29 }	Formations of the battery.....	479	275
	Remarks on the formations.....	479	275
	Measures of the elements composing a battery, and of its formations.....	480	279
	Manning the battery.....	481	279
	ARTICLE II.—MOVEMENTS IN COLUMN.....		281
	To unpark.....	482	281
	Formations into line, and battery from column of pieces.....	483	282
	To halt.....	484	282
	Change of gait.....	485	282
30	To form sections.....	486	283
	In column of pieces, to form the caissons on the flank.....	487	284
	To march in column.....	488	285
	To halt the column.....	489	285
	To change the gait.....	490	285
31 and 32	To march by a flank.....	491	285
33 and 34	Oblique march.....	492	287
	Passage of carriages in column.....	493	288
	About in column.....	494	289
	Countermarch in column.....	495	289
35	To change direction in column.....	496	289
30	To diminish the front of a column on the march..	497	290
	In column, with the caissons on the flank, to re- place them in front or rear.....	498	291
	To form the park.....	499	291
	ARTICLE III.—TO PASS FROM THE ORDER IN COLUMN TO THE ORDER IN LINE, AND THE REVERSE....		292
36	To form forward into line.....	500	292
37	To form line faced to the rear.....	501	293

PLATES		NOS.	PAGE
38	To form line to the right or left.....	502	294
39	To form line on the right or left.....	503	295
40	To break into column to the front.....	504	295
	To break into column to the rear.....	505	296
41	To break into column to the right or left.....	506	297
42	To break into column to the front from one flank, to march towards the other.....	507	297
	To break into column to the rear from one flank, to march towards the other.....	508	298
	To break into column to the front when the bat- tery is marching in line.....	509	298
	To form line advancing.....	510	299
43	To form double column on the centre section.....	511	300
44	To deploy the double column into line to the front	512	302
	To form the double column into line to the right or left.....	514	304
ARTICLE IV.—MOVEMENTS IN LINE.....			306
	To advance in line.....	515	306
	To halt the battery and align it.....	516	306
	Changes of gait.....	517	307
45 and 46	To march by a flank.....	518	307
47 and 48	Oblique march.....	519	307
	Passage of carriages in line.....	520	308
	About in line.....	521	308
	Countermarch in line.....	522	308
49	To change direction in line.....	523	308
50	To close intervals in line.....	525	309
	About, or countermarch with diminished intervals	526	310
51	To resume intervals.....	527	311
	Passage of obstacles.....	528	311
ARTICLE V.—FORMATIONS IN BATTERY.....			313
52	In line, with pieces in front, to form in battery to the front.....	529	313
	In line, to form in battery to the front, by throw- ing the caissons to the rear.....	530	313
52	In line, with caissons in front, to form in battery to the front.....	531	314
53	In line, with pieces in front, to form in battery to the rear.....	532	315

TABLE OF CONTENTS.

XXI

PLATES		NOS.	PAGE
53	In line, with caissons in front, to form in battery to the rear	533	316
54	In battery, to form in line to the front.....	534	316
55	In battery, to form in line to the rear.....	535	317
56	In column, with pieces in front, to form in battery to the front.....	536	319
57	In column, with caissons in front, to form in battery to the front.....	537	319
58	In column, with pieces in front, to form in battery to the rear.....	538	320
59	In column, with caissons in front, to form in battery to the rear	539	321
60, 61 and 62	In column, with pieces in front, to form in battery to the right or left	540	321
63, 64 and 65	In column, with caissons in front, to form in battery to the right or left.....	541	323
	In column, with pieces in front, to form in battery on the right or left.....	542	324
	In column, with caissons in front, to form in battery on the right or left.....	543	325
	To deploy the double column into battery to the front or rear	544	325
	To deploy the double column into battery to the right or left.....	545	326
	To pass from the order in battery to the order in column.....	546	327
66 and 67	To march by a flank.....	547	327
	ARTICLE VI.—FIRINGS.....	548	330
	To fire by battery, half battery, section, and piece	548	330
	To cease firing.....	548	330
	To move and fire with the prolonge.....	549	331
68	To fire advancing.....	550	331
69	To fire retiring	551	332
70	Movements for firing in echelon.....	552	333
	Being in echelon, to form line	553	334
71	To fire to the rear.....	554	335
	ARTICLE VII.—CHANGES OF FRONT IN BATTERY.....	336	
72	Change of front to fire to the right, left wing forward, and the reverse.....	555	336

PLATES		NOS.	PAGE
73	Change of front to fire to the left, left wing forward, and the reverse.....	556	338
74	Change of front to fire to the left, left wing to the rear, and the reverse.....	557	339
75	Change of front to fire to the right, left wing to the rear, and the reverse.....	558	341
76	To pass a defile in front.....	559	342
77	To pass a defile in rear.....	560	343
PARADE FOR REVIEW AND INSPECTION.			
78 and 79	Review of a battery.....	561	344
	Review of a battery in connection with other troops.....	562	346
	To march in review in line or column of half batteries.....	563	347
	Officers' salute with the sabre.....	564	348
	Inspection.....	565	348

INSTRUCTION FOR FIELD ARTILLERY.

PART I.

ORGANIZATION, MATERIÈL, AND SERVICE.

ARTICLE FIRST.

ARTILLERY AND ITS DUTIES.

THE troops of the artillery are divided into two kinds, viz., **Foot Artillery**, and **Light or Field Artillery**.

To the **Foot Artillery** belongs the service of siege, sea-coast, garrison, and mountain artillery, rocket batteries, and the artillery duties of the park.

To the **Field Artillery** belongs the service of *the batteries which manœuvre with the troops on the field of battle*. It is divided into two parts. **Horse Artillery**, which is generally attached to and manœuvres with cavalry, the cannoneers being mounted on horseback; and **Mounted Artillery**, which is generally attached to and manœuvres with infantry, the cannoneers marching at the sides of their pieces, or, when necessary, mounting the ammunition chests.

The **Artillery Reserves** are composed of horse and mounted batteries in such proportions as the nature of the service requires.

The service of batteries assigned to brigades or divisions of cavalry and infantry is special, and, to a great extent, subordinate to the operations of the troops to which they are attached as auxiliaries. The *artillery reserve* is commanded by a superior

officer of artillery, and constitutes a distinct arm of battle, under the immediate orders of the general commanding.

The employment of field artillery, according to the various conditions of service, is a subject of such extent and importance as precludes any attempt to treat of it in this work. It varies with the nature of the theatre of operations; the character of the enemy's defences; the composition of his forces, whether consisting of troops of a single arm or of combinations of the different arms, and according to the discipline, instruction, and numbers of the troops with which it is associated, their composition, and the proportions of the different arms.

FIELD ARTILLERY.

Field artillery is used to attack and defend the works of temporary fortification; to destroy or demolish material obstacles and means of cover, and thus prepare the way for the success of other arms; to act upon the field of battle; to break an enemy's line or prevent him from forming; to crush his masses; to dismount his batteries; to follow and support in a pursuit, and to cover and protect a retreat.

The *effect* of field artillery is generally in proportion to the *concentration of its fire*. It has therefore for its object, not to strike down a few isolated men, and here and there to dismount a gun, but by a combined and concentrated fire to destroy an enemy's cover; to break up his squares and columns; to open his ranks; to arrest his attacks, and to support those which may be directed against him.

Mobility being a prime consideration, both upon the march and on the field of battle, the guns and carriages are made as light as is compatible with strength, and the nature of the service they are required to perform.

Pieces. The calibre and description of the pieces now in use in the service of the United States, are the 6-pounder and 12-pounder gun, the 12-pounder, 24-pounder, and 32-pounder howitzer, and the 12-pounder *light* gun, or, as it is sometimes called, *gun-howitzer*. These are assembled in batteries of six or of eight

pieces on the war establishment, of which four or six are guns, and two are howitzers, and of four pieces, on the peace establishment, of which *three* are guns and *one* a howitzer. The 12-pounder guns, and 24-pounder, or 32-pounder howitzer, are associated together in the same batteries, which are called *12-pounder batteries*, and the 6-pounder guns and 12-pounder howitzers are associated together in like manner, and called *6-pounder batteries*. The 12-pounder light guns are assembled in batteries by themselves.*

Carriages. Each piece is mounted on a carriage adapted both to the service of the gun and its transportation. Other carriages, called *caissons*, constructed for the transport of the ammunition, are attached to batteries at the rate of one to each piece in 6-pounder batteries, and two to each piece in 12-pounder batteries. Besides these carriages, a *travelling forge*, with smiths' and armorers' tools, and stores, for shoeing and ordinary repairs; and a *battery wagon* for stores, materiel, and the tools of the carriage-maker, wheelwright, saddler, and harness-maker, form parts of the battery. Other battery wagons, forges, spare gun-carriages, etc., required for more extensive and rapid repairs, and to replace injured carriages, accompany the general park. If there is no park, they should accompany the battery whenever it takes the field.

The *battery of manœuvre* consists of the pieces belonging to the field battery, with an equal number of caissons, all properly equipped, horsed, and manned. Each caisson is permanently attached to a piece, and manœuvres with it.

Horses. On the war establishment, or when ordered to march, each carriage of the 6-pounder and light 12-pounder batteries is

* This gun is still upon trial. It is not chambered, but can be used both as a gun and howitzer, thus greatly simplifying the ammunition required for a battery. In batteries composed of both guns and howitzers, the fire of one class is often more or less sacrificed to that of the other. This evil is obviated by the use of the light 12-pounder, which will probably be adopted for all mounted batteries, to the exclusion of the others, and be superseded in its turn by rifled cannon of great power and range.

drawn by six horses. On the peace establishment, in garrison, four horses only are required. When 12-pounder batteries are in the field or on the road, each piece and caisson of the battery of manœuvre requires eight horses, the other carriages six horses each.

Personnel. The number of men required for the service of a battery, including non-commissioned officers and artificers, varies from *twenty to thirty* per piece, according to circumstances: the number for field service should never be less than twenty-five, even in 6-pounder batteries. They should be intelligent, active, muscular, well-developed, and not less than five feet seven inches high; a large proportion should be mechanics.

The number of officers varies from four to six, depending on the number of pieces in the battery.

PROPORTION OF FIELD ARTILLERY TO OTHER ARMS.

The proportion of field artillery to other arms varies generally between the limits of 1 and 4 pieces to 1000 men, according to the force of the army; the character of the troops of which it is composed; the force and character of the enemy; the nature of the country which is to be the theatre of the war, and the character and object of the war. Similar considerations must regulate the selection of the kinds of ordnance, and the proportions of the different kinds.

The value and importance of an efficient artillery increases in proportion as the troops with which it serves are undisciplined and uninstructed. The following principles may be observed in the American service, under ordinary circumstances:—

$$3 \text{ pieces to } 1000 \text{ men. } \left\{ \begin{array}{l} \frac{2}{3} \text{ guns, of which } \left\{ \begin{array}{l} \frac{1}{3} \text{ are 12-pdrs.} \\ \frac{2}{3} \text{ are 6-pdrs.} \end{array} \right. \\ \frac{1}{3} \text{ howitzers, of which } \left\{ \begin{array}{l} \frac{1}{3} \text{ are 24-pdrs. or 32-pdrs.} \\ \frac{2}{3} \text{ are 12-pdrs.} \end{array} \right. \end{array} \right.$$

distributed as follows:—

For the infantry: 2 pieces to 1000 men—12-pounder, light, or 6-pounder guns, and 12-pounder howitzers in mounted batteries.

For the cavalry: 2 pieces to 1000 men—6 pounder guns, and 12-pounder howitzers in batteries of horse artillery.

For the reserves: 1 piece to 1000 men— $\frac{1}{3}$ to $\frac{1}{2}$ in 6-pounder mounted batteries and horse artillery, $\frac{2}{3}$ to $\frac{1}{2}$ in 12-pounder mounted batteries.

ARTICLE SECOND.

ORGANIZATION AND EQUIPMENT OF FIELD
BATTERIES.

THERE are three distinct organizations for field batteries :—

1. The peace organization, or that for instructions, simply.
2. That for the *march*, or of preparation for service.
3. That for war.

The first organization, that for *instruction*, requires that the battery of *manœuvre*, only consisting of four pieces, with their caissons, should be horsed. As the movements are executed with empty ammunition chests, the number of horses, and especially in the 6-pounder batteries, may be limited to four for each carriage. The battery wagon and forge, although not horsed, should be at all times with the battery, and provided with the stores and tools for service.

The additional guns and caissons, with their equipments and harness, to complete the battery to the war establishment, should be kept with it, or in store ready for issue.

The second organization, that of *preparation for service*, requires that the battery of *manœuvre*, and also the forge and battery wagon, should be kept fully horsed, manned, and equipped. As the ammunition and stores must be transported, the carriages require six horses each, and the artificers, as well as the chiefs of pieces and buglers, should be mounted. On the inland frontiers, or at interior stations, where batteries, when put in motion, must take the road, they should be kept on this organization.

The third organization requires that the full battery of six or eight pieces should be equipped in all respects for war. When there is no reserve park with the troops, the additional battery wagon, forge, and other carriages which usually accompany it, with their stores and supplies, and the full campaign allowance

of ammunition, should accompany the battery under charge of its commanders.

ORGANIZATION OF A SIX-POUNDER MOUNTED BATTERY.

	INSTRUCTION. 4 pieces.			PREPARATION. 4 pieces.			WAR. 6 pieces.			Remarks.
	Officers.	Men.	Horses.	Officers.	Men.	Horses.	Officers.	Men.	Horses.	
Captain.....	1	1	1	Com'dg sections and caissons. First sergeant and qr.mr. sergeant. Chiefs of pieces. Gunners and chief of caissons.
Lieutenants...	3	3	4	
Staffsergeants...	...	2	2	...	2	2	...	2	2	
Sergeants.....	...	4	4	...	4	4	...	6	6	
Corporals.....	...	8	8	12	
Artificers.....	...	2	4	4	...	6	6	
Buglers.....	...	2	2	...	2	2	...	2	2	
Drivers.....	...	24	32	...	40	60	...	52	84	
Cannoneers...	...	34	40	70	
Spare.....	4	8	10	
	4	76	44	4	100	80	5	150	110	

In batteries of horse artillery two men and twelve horses per piece (one horse spare) are required in addition to the numbers given in the table.

When batteries are ordered on service on the plains, the number of spare draught horses should be increased to one pair for each carriage.

COMPOSITION AND EQUIPMENT OF A BATTERY FOR WAR.

The battery is supposed to consist of six pieces. In batteries of eight pieces there are two additional guns, with the materiel required for their service.

		12-pdr. battery.	12-pdr. (light.)	6-pdr. battery.	
PIECES AND CARRIAGES.	Guns	{ 12-pounder, mounted	4	
		{ 12-pounder, (light,) mounted	6	
	Howitzers..	{ 6-pounder, mounted.....	4	
		{ 24-pounder, mounted.....	2	
		{ 12-pounder, mounted.....	2	
		Total number of pieces.....	6	6	6
	Caissons....	{ for guns.....	8	12	4
		{ for howitzers	4	2
		Total number of caissons.....	12	12	6
		TRAVELLING FORGE.....	1	1	1
	BATTERY WAGON.....	1	1	1	
	Whole number of carriages.....	20	20	14	
AMMUNITION FOR	Guns	{ Shot.....	560	504	400
		{ Spherical case.. ..	224	504	320
		{ Shells.....	168
		{ Canisters.....	112	168	80
	Howitzers..	{ Spherical case.....	112	160
		{ Shells.....	168	120
		{ Canisters.....	42	32
		Total number of rounds with a battery..	1,218	1,344	1,112

For two 32-pounder howitzer carriages, and four } Spherical case 84
 caissons, the number of rounds of ammunition } Shells..... 112
 would be..... } Canisters 14

Total..... 210

The number of friction primers is fifty per cent. greater than the number of rounds furnished the battery. To provide for contingencies, a small supply of port-fires and slow-match is also furnished with the ammunition.

The campaign allowance of ammunition is double what has been here prescribed, or about 400 rounds *per piece*, of which about 200 rounds per piece accompany the battery, the remainder being with the reserve parks.

FIELD PIECES.

The pieces are cast in *bronze* or *gun-metal*, and are much less liable to burst than those made of iron.

Bronze for cannon, (commonly called **brass**,) consists of 90 parts of copper and 10 of tin, allowing a variation of 1 part of tin, more or less. It is more fusible than copper; much less so than tin; is harder, less susceptible of oxidation, and much less ductile than either of its components. The specific gravity of bronze is about 8.70, being greater than the mean of the specific gravities of copper and tin; that of iron is about 7.25. The **tenacity** of bronze is also greater than that of iron.

The external forms of the pieces, and their nomenclature, are shown in Plates 6 and 7. The howitzers only are chambered: the 6-pounder gun and 12-pounder howitzer have no handles.

The **preponderance**, is the excess of the weight of the piece in rear of the trunnions over that in front; it is measured by the lifting power, in pounds, which must be applied at the rear of the base ring, to balance the gun when suspended freely on the axis of the trunnions.

The **true windage**, is the difference between the true diameters of the bore and of the ball.

PRINCIPAL DIMENSIONS AND WEIGHTS OF FIELD PIECES.

	GUNS.			HOWITZERS.		
	12-pdr.	Light 12-pdr.	6-pdr.	32-pdr.	24-pdr.	12-pdr.
Diameter of the bore.....	<i>inches.</i> 4·62	<i>inches.</i> 4·62	<i>inches.</i> 3·67	<i>inches.</i> 6·4	<i>inches.</i> 5·82	<i>inches.</i> 4·62
True windage.....	0·10	0·10	0·09	0·15	0·14	0·10
Length of bore, (exclusive of chamber).....	74·	63·6	57·5	64·	56·25	46·25
Length of bore in diameters.	16·	13·76	15·67	10·	9·66	10·
Diameter of the chamber...	4·62	4·62	3·67
Length of the chamber.....	7·	4·75	4·25
Length from rear of base ring to face of muzzle...	78·	66·	60·	75·	65·	53·
Whole length of the piece...	85·	72·15	65·6	82·	71·2	58·6
Semi-diameter of the base ring.....	6·5	5·5	5·15	6·9	6·	5·
Semi-diameter of the swell of the muzzle.....	5·17	4·25	4·125	5·6	4·875	4·1
Distance between these two semi-diameters.....	76·3	65·	58·7	74·75	64·8	52·85
Natural angle of sight.....	1°	1° 6'	1°	1°	1°	1°
Distance from rear of base ring to rear of trunnions.	30·7	25·4	23·25	30·7	27·5	23·25
Diameter of the base ring..	13·	11·	10·3	13·8	13·8	12·
Distance between the rim- bases.....	12·	11·5	9·5	12·	11·5	9·5
Length of the trunnions...	3·5	3·25	2·8	3·5	3·25	2·8
Diameter of the trunnions..	4·62	4·2	3·67	4·62	4·2	3·67
Distance from axis of trun- nions to face of muzzle...	44·99	38·5	34·91	41·99	35·4	27·91
WEIGHT..... pounds.	1,757	1,227	884	1,920	1,318	788
Preponderance..... pounds.	60	123,5	33	125	112	51

Ammunition.

GUNPOWDER.

Gunpowder is composed of *nitre*, (saltpetre,) charcoal, and sulphur; the proportions of the ingredients and the size of the grain varying with the uses for which it is destined.

Powder for the military service is composed of 75 or 76 parts, by weight, of nitre, to 15 or 14 parts of charcoal, and 10 of sulphur. It is *glazed*, in order to enable it to resist the effects

of shaking in transportation, and of exposure to the moisture of the air. For sporting purposes there are 2 parts more of nitre, and 2 parts less of charcoal, and the grain is very small.

Gunpowder burns at a temperature of from 575° to 600° Fahr. If made of pure materials, well glazed, and kept in proper casks in a dry magazine, it absorbs less than 1 per cent. of moisture in from 10 to 15 years. If freely exposed to air saturated with moisture, it will absorb 2 per cent. or more in 24 hours.

DENSITY OF GUNPOWDER.

SIZE OF GRAIN.	Specific gravity.	No. of grains of powder in 10 grs. Troy	Weight of 1 cubic foot.		Cubic inches in 1 lb. loose.
			Loose.	Shaken.	
Cannon.....	1,912	150	oz. 929	oz. 1,039	30·
Musket.....	1,983	1,100	896	1,012	30·8
Rifle.....	6,000	900	1,060	30·7
Sporting.....	2,012	73,000	1,047	1,197	26·5
Powder, loose.....	900
Powder, shaken.....	1,000
WATER.....	1,000	998,07

PROOF OF GUNPOWDER.

The projectile force of gunpowder is ascertained by means of the *cannon pendulum*, and the *musket pendulum*. The apparatus shows the initial velocity of a ball fired from a cannon or a musket with the ordinary service charge.

In proving cannon powder, the initial velocity of a ball of medium weight and windage, with a charge of *one-fourth* its weight of powder, should be:—

From a 24-pounder garrison gun, not less than 1600 feet.

From a 12-pounder field gun, not less than 1550 feet.

From a 6-pounder field gun, not less than 1500 feet.

In proving small-arm powder, the initial velocity of a musket ball, with a charge of 120 grains, should be:—

With musket powder, not less than 1500 feet.

With rifle powder, not less than 1600 feet.

With fine sporting powder, not less than 1800 feet.

CHARGES OF POWDER.

KIND.	FOR GUNS.		FOR HOWITZERS.		
	12-pdrs.	6-pdrs.	32-pdrs.	24-pdrs.	12-pdrs.
	<i>lbs.</i>	<i>lbs.</i>	<i>lbs.</i>	<i>lbs.</i>	<i>lbs.</i>
For shot	2.5	1.25
For spherical case.....	2.5	1.25	3.25	2.5	1.25
For canister.....	2.	1.	2.5	2.	1.
For shells... {	small charge.....	2.5	2.
	large charge.....	3.25	2.5
	fixed.....	2.5	1.

The same ammunition is used for the 12-pounder and light 12-pounder guns.

The charges are contained in **cartridge bags**, made of woollen material free from any mixture of cotton, and of sufficiently close texture to prevent the powder from sifting through.

PROJECTILES.

(PLATE 1.) There are four kinds of projectiles used in field service, viz.: the **solid or round shot**, the **canister**, the **shell**, and the **spherical case shot**.

The projectile is attached to a block of wood called a **sabot**. For the guns and the 12-pounder howitzer, the cartridge and the projectile are attached to the same sabot, making together a *round of fixed ammunition*. For 32-pounder and 24-pounder howitzers, the projectile is separate from the charge, and the cartridge is attached to a block of wood called a *cartridge block*.

The **solid shot** is spherical, and its weight in pounds is used to designate the calibre of the gun to which it belongs.

The **canister** consists of a tin cylinder, attached to a sabot and filled with *cast-iron shot*. These shot vary in diameter, and of course in weight, with the calibre and description of the piece. Canisters for guns contain 27 shots each; those for howitzers contain 48 shots each. They are packed in sawdust in four tiers: the lower tier rests on a rolled iron plate, which is placed on the

sabot; and the canister is closed with a sheet-iron cover. The canister takes its designation from that of the piece for which it is prepared.

The shell is a hollow shot, with such thickness of metal as enables it to penetrate earth works, wooden buildings, etc., without breaking. For service it is charged with powder, and bursts with great force. Fire is communicated to the charge by means of a fuze, inserted in the hole through which the powder is introduced; the time of the explosion being regulated by the preparation of the fuze. The shell is designated by the weight of the solid shot of the same diameter.

CHARGING SHELLS.

Charges.	32-pdr.	24-pdr.	12-pounder.	
			Gun.	Howitzer
	<i>lb. oz.</i>	<i>lb. oz.</i>	<i>lb. oz.</i>	<i>lb. oz.</i>
Powder required { to fill the shell.....	1 5	1 0	0 8	0 8
{ for service charge..	1 0	0 12	0 7	0 7

Rifle or musket powder is used in preference to cannon powder.

The Shrapnell, or spherical case shot, is a hollow cast-iron shot forming a case which is filled with musket balls. Melted sulphur or resin is poured in to fill up the interstices and secure the balls in their positions. After this is solidified, a portion of the contents is bored out and the vacant cylindrical space filled with powder, the amount of the charge being only sufficient to rupture the case, which has less thickness of metal than the shell, and to disperse the contents. Fire is communicated to the charge by the means employed for exploding the shell. The Shrapnell shot, so called from the name of its inventor, an officer of the British artillery, produces the same effect as the canister, and can be used for much greater distances. It takes its designation from that of the piece.

Sabots.

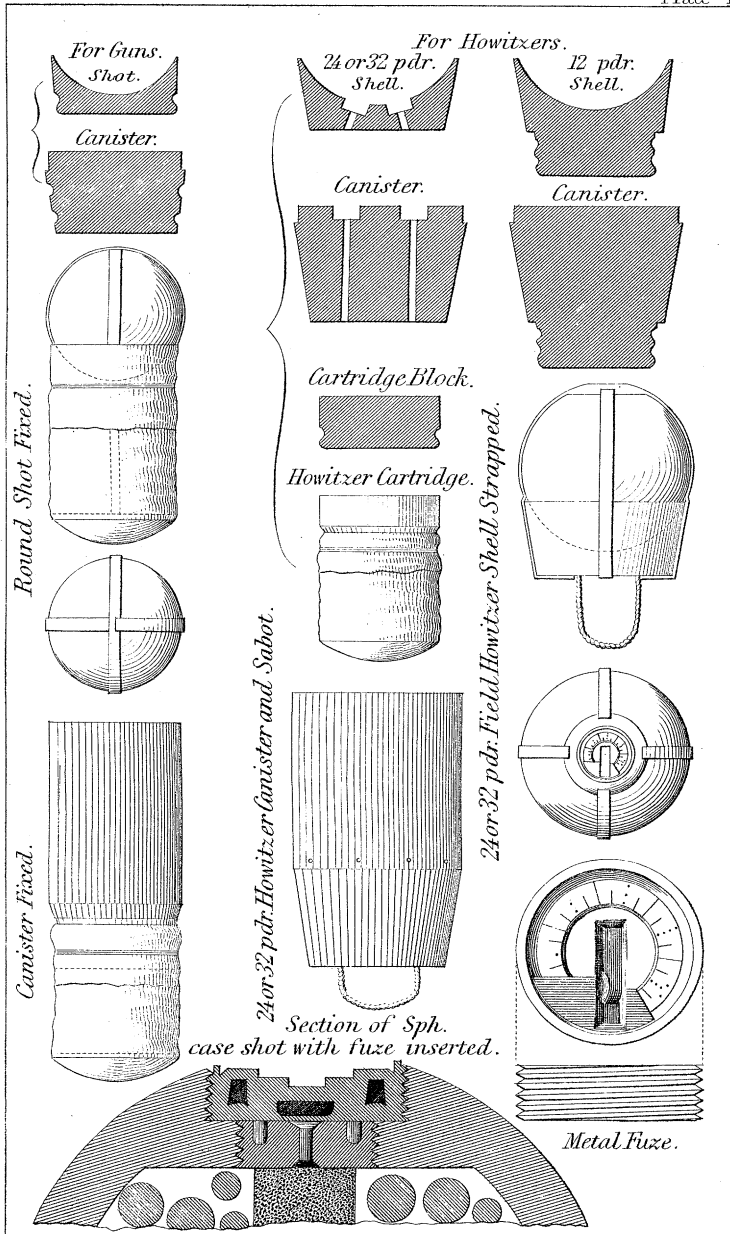

CHARGES FOR SPHERICAL CASE SHOT.

	32-pdr.	24-pdr.	12-pdr.	6-pdr.
Number of musket balls.....	245	175	76	37
Bursting charge of powder.....oz.	1.4	1.2	1.	0.5
Weight of shot, loaded.....lbs.	32	24	11.77	5.55

FUZE.

(PLATE 1.) The **Bormaun fuze**, so called from the name of its inventor, an officer of the Belgian artillery, is the only kind at present used in the field artillery service. This fuze is a circular metallic disc, about 1.5 inches diameter, and half an inch thick. On the exterior are several turns of a stout thread, which enables the disc to be screwed into the shell. The composition filling (mealed powder) is compressed in a circular groove near to, and concentric with, the circumference of the disc. The end of the composition communicates by a canal with a small magazine in the centre of the disc. The magazine is filled with powder, and slightly closed on the lower side so as to yield in that direction to the explosion. The composition is securely protected from moisture or accidental ignition by a covering of soft metal, on which is legibly marked the time graduations in seconds and parts of a second. Commencing at the entrance to the magazine, on the left end of the composition, the first mark, a short one, is for $\frac{3}{4}$ of a second; the next, *one dot*, or the figure 1, is for 1 second; the next, a short mark, for $1\frac{1}{4}$ seconds; the next, a long mark, $1\frac{1}{2}$ seconds; the next, a short mark, $1\frac{3}{4}$ seconds; the next, two dots, or the figure 2, is for 2 seconds; and so on in succession up to $5\frac{1}{4}$ seconds, which is the longest time for which these fuzes are constructed.

As the fuze exposes considerable surface to the shock of movement, it is sustained within the shell by a thick iron plate, perforated through the centre so as to permit the passage of the flame from the fuze into the interior of the shell when the magazine explodes.

This plate is screwed into an orifice prepared for its reception, and

closes the lower part of the fuze-hole. The metallic fuze is then screwed firmly into its place, and the projectile is ready for service.

The operation of the fuze in service is as follows: the thin covering of metal above the composition is cut at the desired point so as to lay bare the upper surface and expose it to the flame of the discharge. The combustion of the composition occupies the assigned time, and then, through the canal already mentioned, communicates fire to the magazine. The explosion drives the flame downward through the orifice in the iron plate into the interior of the projectile, where it encounters the charge of the latter.

The fuze-gouge, a small gouge with a wooden handle, is required to cut the metallic cover and expose the composition. Two fuze-gouges should be supplied to each piece.

FRICION PRIMERS.

The primer is a small tube filled with rifle powder and inserted in the vent at the moment of firing. It is ignited by the friction produced in drawing a rough wire briskly through a friction composition, consisting of 1 part of chlorate of potassa and 2 parts of sulphuret of antimony, moistened with a weak solution of gum arabic, and mixed together in a wet state. This composition is contained in a smaller tube which is inserted at right angles in the priming-tube, near the top, and soldered to it. A *tanyard*, with a hook attached, is used to pull out the wire.

Ammunition is issued to batteries from the arsenals, prepared for immediate use. It is packed in boxes made for the purpose: these are painted olive color on the outside, and the kind of ammunition contained in each is marked on both ends in white letters. The date and place of fabrication are marked on the inside of the cover.

When fresh ammunition is received, it should at once be gauged to the pieces, and its condition examined. It should be frequently aired, and every care taken to keep it in good order. The primers should be kept in a dry place, and exposed to the sun before being used. In rainy weather, especially when long continued, and an action may be expected, they should be dried carefully, in small separate parcels, before a fire.

WEIGHTS OF FIXED AMMUNITION.

	FOR GUNS.		FOR HOWITZERS.			
	12-pdr.	6-pdr.	32-pdr.	24-pdr.	12-pdr.	
	<i>lbs.</i>	<i>lbs.</i>	<i>lbs.</i>	<i>lbs.</i>	<i>lbs.</i>	
Cartridge, including cartridge block.....	large charge	2.56	1.3	3.88	2.7	1.3
	small charge	2.06	1.05	3.1	2.34	1.05
Shot, strapped.....	12.75	6.28	
Shell, strapped and charged.....	9.52	24.6	18.8	9.35	
Spherical case, strapped and charged.....	12.17	5.72	32.72	24.64	12.2	
Canister, with sabot.....	14.8	7.32	28.5	21.25	10.8	
Round of ammunition.....	Shot.....	15.4	7.6	
	Shell.....	12.17	27.7	21.15	10.5
	Spherical case.....	14.7	7.	35.82	27.	13.65
	Canister.....	16.91	8.4	31.6	23.6	11.85

CONTENTS AND WEIGHTS OF PACKING BOXES.

KIND OF AMMUNITION.	No. of rounds.	WEIGHT.		Remarks.	
		Empty.	Packed.		
FOR GUNS.					
12-PDR..	Shot.....	8	23	148	Each box contains the port fire and $\frac{1}{2}$ yard of slow-match.
	Spherical case.....	8	23	142	
	Shells.....	8	23	121	
	Canister.....	8	24	161	
6-PDR..	Shot.....	14	25	133	
	Spherical case.....	14	25	125	
	Canister.....	14	26	146	
FOR HOWITZERS.					
32-PDR..	Shells.....	4	23	136	Friction primers are furnished in tin boxes containing 100 each.
	Spherical case.....	4	23	168	
	Canister.....	4	25	158	
24-PDR..	Shells.....	6	25	155	
	Spherical case.....	6	25	190	
	Canister.....	6	26	170	
12-PDR.	Shells.....	10	27	133	
	Spherical case.....	10	27.5	165	
	Canister.....	10	28.5	148	

FIELD CARRIAGES.

All field carriages consist of two parts—the *body* or main portion of the carriage, and the *limber* or front part, to which the horses are attached. These parts are so connected as to be readily detached and separated from each other.

Gun-carriages, (PLATES 8 and 9.) There are three gun-carriages for field artillery, viz.:—

One for the 6-pounder gun and the 12-pounder howitzer.

One for the 24-pounder howitzer.

One for the 12-pounder gun and the 32-pounder howitzer.

The 12-pounder light gun is for the present mounted on the 24-pounder howitzer carriage, modified slightly for the purpose. A special carriage will probably be adopted for it.

The parts of these carriages are all similar, differing only in their dimensions.

Caissons, (PLATES 12 and 13.) All caissons are of the same external forms and dimensions.

Battery wagons, (PLATES 14 and 15,) are of the same external forms and dimensions. The one which accompanies the battery differs in its equipment from that of the field park, and also in its external arrangements and contents.

Travelling forges, (PLATES 16 and 17.) The remarks as to the forms, dimensions, and equipments of the battery wagons, apply also to the forges for the field batteries and parks.

Limbers, (PLATES 10 and 11.) The same limber is used for all field carriages. The limber chests of the gun-carriage and caisson contain ammunition and equipments for the service of the piece; those of the forge and battery wagon contain tools and stores for shoeing and repairs.

Wheels. There are two numbers of wheels for field carriages, viz.: No. 1, for the 6-pounder gun-carriage, the caisson, the forge, the battery wagon, and for the limbers of all field carriages. No. 2, for the 12-pounder gun-carriage and 24-pounder howitzer, or light 12-pounder gun-carriage. These wheels are of the same form and height, and they fit on the same axletree-arm;

they differ only in the dimensions of their parts, and consequently in strength and weight.

Ammunition chests, (PLATE 2.) The same ammunition chest is adapted to the limber and to the caisson. The interior arrangement varies with the calibre and description of the piece and the ammunition to be used. The principal divisions are designated as the *right half* and the *left half* to a person facing the *front*, or *lock-side* of the chest. The smaller divisions in each half perpendicular to the sides are designated as the *first, second, third, etc.*, from the principal partition, each way; the divisions parallel to the sides are designated as the *front, middle, and rear* divisions.

Chest for 6-pounder Gun. Eight partitions, four in each half, perpendicular to the sides of the chest, and sliding in grooves made for the purpose. All the divisions of the right half, except the fifth, are provided with two *bolsters* each, for spherical case shot: the bolsters are attached to the partitions by *screws*; the wooden strips which form the grooves, the *linings*, and the *props*, for shells and spherical case, are secured with *copper nails*. One *tray*, for holding equipments, rests on the partitions in the left half of the chest. Three finger holes are bored in the inside of the ends, to lift it by; and a hole is bored through the middle of the bottom to let the air pass when the tray is lifted out.

Chest for light 12-pounder Gun. Six partitions, three in each half, perpendicular to the sides: four of the divisions are provided with *bolsters* for shells and spherical case shot; and one division is separated from the rest by partitions of sufficient height to suit that of the canisters. One *tray*, for equipments, in the left half, as in the 6-pounder chest.

Chest for 12-pounder Gun. Six partitions, three in each half, perpendicular to the sides. Four bolsters for spherical case shot. One division is prepared for canisters, as in the light 12-pounder gun. One tray for equipments, in the left half.

Chest for 12-pounder Howitzer. Six partitions, three in each half, perpendicular to the sides. Twenty-one bolsters for the lower tier of shells and spherical case shot. They are cupped

to receive the balls, and have holes bored through the bottom for the fuzes to lie in. They are placed in the bottom of the chest, three in each division, except the division prepared for the canisters. Twenty-eight *props*, for the upper tier of shells and spherical case, four in each division, except that for the canisters. Six props for canisters in the first division, right half.

Chest for 24-pounder Howitzer. *Eight linings*, two in each of the front and rear divisions, fastened to the ends of the chest and to the principal partitions. *Four long partitions*, two in each half, parallel to the sides of the chest. *Two short partitions for canisters*, in the rear division of the right half. *Seven short partitions* for shells and spherical case shot; two in each of the front divisions, two in the rear division of the left half, and one in the middle division of the right half: each of these partitions is formed of two pieces which slip into grooves, one over the other. *Thirty-three bolsters* for shells and spherical case, in the two front divisions—the left rear division, and the right middle division: they are so placed as to support two tiers of shot and shell.

Chest for 32-pounder Howitzer. *Six long partitions*, three in each half; one parallel to the ends, and two parallel to the sides of the chest. *Four short partitions*, one in the front and rear divisions of each half, made in two pieces, and fastened as in the 24-pounder howitzer chest. *Twenty-one bolsters* for shells and Shrapnell shot in the front and rear divisions, left half; the rear division, right half; and on the right of the front division, right half; they are arranged as in the 24-pounder howitzer chest, so as to support two tiers of shot and shells.

AMMUNITION CARRIED IN EACH CHEST.

KIND.	No.	Weight.	Place.
<i>Lbs.</i>			
FOR 6-POUNDER GUN.			
Shot, fixed.....	25	190	In the left half.
Spherical case, fixed.....	20	140	In 1st, 2d, 3d, and 4th divisions, right half.
Canisters, fixed.....	5	42	In 5th division, right half.
Spare cartridges1½ lbs.	2	2·5	On the spherical case.
Friction primers.....	75	·6	In tube pouches, or bundles in the tray.
Slow-match.....yards.	1·5	·4	} On the ammunition in right half.
Port-fires.....	3·	·6	
		376·1	
FOR LIGHT 12-POUNDER GUN.			
Shot, fixed.....	12	184·8	In 2d, 3d, and 4th divisions, left half.
Spherical case, fixed.....	12	176·4	In 1st, 2d, and 3d divisions, right half.
Shells, fixed.....	4	48·7	In 1st division, left half.
Canisters, fixed.....	4	67·6	In 4th division, right half.
Spare cartridges.....2½ lbs.	2	5·	On the spherical case.
Friction primers.....	48	·4	In tube pouches, or in the tray.
Slow-match..... yards.	2	·5	} On the ammunition, right half.
Port-fires.....	4	·7	
		484·1	
FOR 12-POUNDER GUN.			
Shot, fixed.....	20	308·	In left half, and 4th division, right half.
Spherical case, fixed.....	8	117·6	In 1st and 2d divisions, right half.
Canisters, fixed.....	4	67·6	In 3d division, right half.
Spare cartridges.....2½ lbs.	2	5·	On the spherical case.
Friction primers.....	48	·4	In tube pouches, or in the tray.
Slow-match.....yards.	2	·5	} On the ammunition in right half.
Port-fires.....	4	·7	
		499·8	

AMMUNITION CARRIED IN EACH CHEST—(Continued.)

KIND.	No	Weight.	Place.	
FOR 12-POUNDER HOWITZER.				
Shells, fixed.....	15	<i>lbs.</i> 157·5	In 2d, 3d, and 4th divisions, right half.	
Spherical case, fixed.....	20	273·		
Canisters, fixed.....	4	47·4	In left half.	
Friction primers.....	60	·5	In 1st division, right half.	
Slow-match..... yards.	1·5	·4	In tube pouches, or in bundles on canisters, etc.	
Port-fires.....	3	·6		
		479·4		
FOR 24-POUNDER HOWITZER.				
Shells, strapped.....	12	225·6	In left half.	
Spherical case, strapped.....	8	197·1	In front and middle divisions, right half.	
Canisters.....	3	63·8	In rear divisions of right half.	
Cartridges.. {	small charge....	23	54·	12 in mid. divis., left half; 9 in mid. divis., right half; 2 on canisters.
	large charge....	2	5·4	
Friction primers.....	36	·3	On canisters	
Slow-match..... yards.	2	·5		
Port-fires.....	4	·7		
		547·4	} As for 12-pdr. howitzer.	
FOR 32-POUNDER HOWITZER.				
Shells, strapped.....	8	196·8		Front and rear divisions of left half.
Spherical case, strapped.....	6	196·3	Rear divisions, and right front div. of right half.	
Canisters.....	1	28·5	Left front division, right half.	
Cartridges.. {	small charge....	15	46·5	} 1st division in each half.
	large charge....	1	3·9	
Friction primers.....	24	·2	In tube pouches, or in middle division.	
Slow-match..... yards.	2	·5	} In middle divisions.	
Port-fires.....	4	·7		
		473·4		

Ammunition Chests.

6.Pdr. Gun.

Plan.

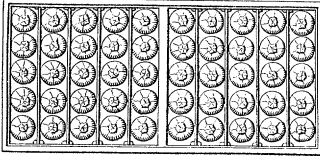

Elevation.

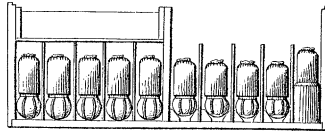

12 Pdr. Gun.

Plan.

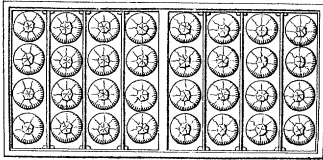

Elevation.

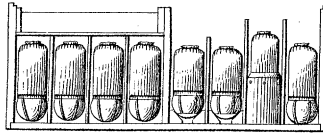

12 Pdr. Howitzer.

Plan.

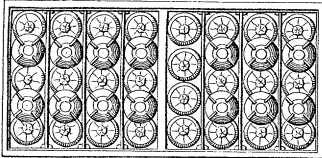

Elevation.

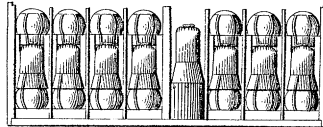

24 Pdr. Howitzer.

Plan.

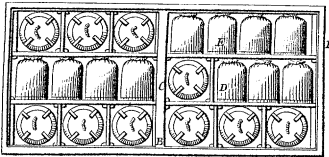

Elevation.

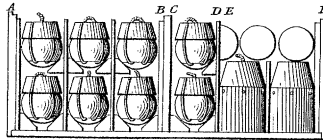

32 Pdr. Howitzer.

Plan.

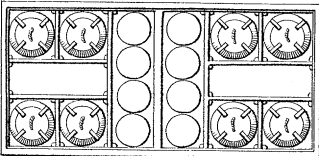

Elevation.

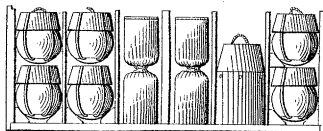

In packing ammunition in the chests, care must be taken to place the rounds in their proper position, and then to secure them from movement by filling all the void spaces closely with packing-tow. The tow should be inserted in small portions, and packed down with a straight, smooth stick, prepared for the purpose. When ammunition is not firmly secured, the shaking of the carriage soon injures the powder, and renders the firing uncertain.

IMPLEMENTS AND EQUIPMENTS FOR FIELD PIECES.

KIND.	No.	Weight.	Place.
FOR A GUN CARRIAGE.		<i>lbs.</i>	
Sponges and rammers.....	2	11.6	} For 6-pounder—9 lbs.
Sponge covers.....	2	.28	
Worm and staff.....	$\frac{1}{2}$	3.6	} On the carriage.
Handspikes.....	2	14.5	
Sponge bucket.....	1	10.	} On the limber.
Prolonge.....	1	18.	
Tar bucket.....	1	7.	
Water buckets, leather.....	2	16.	
Gunner's haversacks.....	2	3.72	} In the implement trays, or in the other vacant spaces in the ammunition chest.
Tube pouches.....	2	1.90	
Fuze-gouges.....	1	.5	
Fuze-wrench.....	1		
Vent punch.....	1	.08	
Gunners's pincers.....	1	.85	
Tow hook.....	1	.60	
Pendulum hausse.....	1	.50	
Thumbstalls.....	2	.02	
Priming wires.....	1	.08	
Lanyards.....	2	.10	} In the tube pouches.
Gunner's gimlet.....	1	.08	
Tarpaulin, large.....	1	54.	Strapped on the am'tion chest.
FOR A CAISSON.			
Felling axe.....	1	6.	} In the places provided for them on the caisson body.
Shovel, long handle.....	1	4.75	
Pickaxe.....	1	6.50	
Spare handspike.....	1	7.25	
Spare pole.....	1	25.30	
Spare wheel.....	1	180.	} In limber chest.
Fuze-gouge.....	1	.5	
Tow hooks.....	2	1.2	One in limber chest, one in rear chest.
Tar bucket.....	1	7.	} On the limber.
Watering buckets, leather.	2	16.	
Tarpaulin, large.....	1	54.	Strapped on limber chest.

WEIGHTS OF GUN CARRIAGES AND CAISSONS EQUIPPED FOR
FIELD SERVICE.

DESIGNATION.	FOR GUN.			FOR HOWITZERS.		
	12-pdr.	12-pdr. (light.)	6-pdr.	32-pdr.	24-pdr.	12-pdr.
GUN CARRIAGE.						
Gun	<i>lbs.</i> 1,757	<i>lbs.</i> 1,227	<i>lbs.</i> 884	<i>lbs.</i> 1,890	<i>lbs.</i> 1,318	<i>lbs.</i> 788
Gun carriage without wheels.....	783	736	540	783	736	540
Two wheels.....	392	392	360	392	392	360
Limber body without wheels.....	335	335	335	335	335	335
Two wheels.....	360	360	360	360	360	360
Ammunition chest.....	182	182	185	192	198	206
Ammunition packed.....	505	490	381	480	554	485
Implements and equip- ments.....	89	89	86	89	89	86
Tarpaulin	54	54	54	54	54	54
Total weight.....	4,457	3,865	3,185	4,575	4,036	3,214
Number of rounds on each limber	32	32	50	15	23	39
CAISSON.						
Body without wheels.....	<i>lbs.</i> 432	<i>lbs.</i> 432	<i>lbs.</i> 432	<i>lbs.</i> 432	<i>lbs.</i> 432	<i>lbs.</i> 432
Two wheels.....	360	360	360	360	360	360
Two ammunition chests....	364	364	370	384	396	412
Ammunition packed in chests.....	1,010	980	762	960	1,108	970
Limber.....	335	335	335	335	335	335
Two wheels.....	360	360	360	360	360	360
Ammunition chest.....	182	182	185	192	198	206
Ammunition packed in chest.....	505	490	381	480	554	485
Implements and spare parts, Tarpaulin	254	254	254	254	254	254
Total weight.....	3,856	3,811	3,493	3,811	4,051	3,868
Number of rounds on cais- son and its limber.....	96	96	150	45	69	117

EQUIPMENT OF TRAVELLING FORGES AND BATTERY WAGONS.

One forge and one battery wagon accompany each field battery. They are furnished with the tools and materials required for shoeing horses and for ordinary repairs and preservation of carriages and harness.

Other forges and battery wagons, equipped for the general service of the army, accompany the field park, which contains the general supplies of ordnance stores.

The forge for the field battery is designated by the letter A.
 The forge for the field park “ “ “ B.
 The battery wagon for the field battery “ “ C.
 The battery wagon for the field park “ “ D.

Equipment of a Forge for a Field Battery.

INTERIOR ARRANGEMENT OF THE LIMBER CHEST.

The chest is marked: FORGE A.

There are *five boxes* for tools and stores; *one shoeing box*, and *one can* for oil.

The boxes are marked: A, Nos. 1, 2, 3, 4, 5.

They are made of white pine, .75 inches thick, with loose covers of the same thickness; the covers have three $\frac{3}{4}$ inch holes bored in each end, to lift them by.

Two handles of double leather are nailed on the inside of the ends of the boxes, so as not to interfere with the covers.

The sides and ends of all the boxes for the forges and battery wagons are dovetailed together, and fastened with *8d. nails*; the covers are made with clamps on the ends.

EXTERIOR DIMENSIONS OF THE BOXES FOR FORGE A.

DESIGNATION.	Length.	Width.	Depth.	Weight.	Remarks.
	<i>in.</i>	<i>in.</i>	<i>in.</i>	<i>lbs.</i>	
A, Nos. 1 & 3,	17·8	13·25	7·5	8·25	
A, No. 2.....	17·8	13·25	7·5	9·75	A partition at 4·5 in. from one end.
A, No. 4.....	23·5	8·	6·5	8·	A partition for oil can, at 5·25 in. from one end.
A, No. 5.....	39·8	9·8	6·5	14·5	
Shoeing box..	16·5	8·	6·5	4·7	

The *oil can* is made of tin, to hold 1 quart; it is 5 inches square and 4 inches high, with a neck for a cork, 1 inch diameter and .5 inches high, near one corner. Weight 0.9 pounds. It is marked: A, SPERM OIL.

Boxes Nos. 1, 2, and 3, are placed in the bottom of the chest; No. 1 against the left hand; No. 2 in the middle.

No. 4 is placed on top of Nos. 1 and 2, against the left end and the back of the chest; the division for the oil can on the left hand.

No. 5 is placed on top of Nos. 1, 2, and 3, against the front of the chest.

The shoeing box is placed on No. 3, against the right end and the back of the chest.

The tools and stores in all the boxes, and in the forges and battery wagons, are securely packed with tow.

CONTENTS OF THE LIMBER CHEST OF FORGE A.

SMITH'S TOOLS AND STORES.	No.	Weight.	Place.	
		<i>lbs.</i>		
Horseshoes, Nos. 2 and 3.....lbs.	100	100.00	Box A, 1.	
Horseshoes, Nos. 2 and 3.....lbs.	100	100.00	Box A, 3.	
Horseshoe nails, Nos. 2 and 3 ..lbs.	50	50.00	Box A, 2; large div'n.	
Washers and nuts, No. 2.....	30	5.25	} In Box A, 2. 91.11 lbs.	
Washers and nuts, No. 3.....	10	3.20		
Washers and nuts, No. 4.....	4	2.15		
Nails, No. 1, C.....lb.	1	1.00		
Nails, No. 2, C.....lbs.	1	1.00		
Tire bolts.....	20	5.00		
Keys for ammunition chests.....	5	1.80		
Linch washers.....	8	7.30		
Linch pins.....	12	8.37		
Chains, Nos. 1 and 2..... ft.	2	1.54		
Cold shut S links, No. 3.....	50	2.50		
Cold shut S links, No. 5.....	12	2.00		
Hand cold chisels.....	2	2.00		} In Box A, 4. 28.52 lbs.
Hardie.....	1	0.75		
Files, assorted, with handles.....	12	10.00		
Buttress.....	1	1.50		
Hand punches, round and square,	2	2.00		
Carried forward.....	307.36		

CONTENTS OF LIMBER CHEST—(Continued.)

SMITH'S TOOLS AND STORES.	No.	Weight.	Place.
		<i>lbs.</i>	
Brought forward	307.36	
Screw wrench.....	1	2.42	} In Box A, 4. 28.52 lbs.
Hand screw-driver	1	0.32	
Hand vice	1	1.00	
Pair smith's callipers.....	1	0.40	
Taps.....	} Nos. 1, 2, 3, and 4....	1.50	
Pairs dies. }		1.83	
Wood screws, 1 in., No. 14..gross.	1	2.10	
Quart can of sperm oil.....	1	2.70	
Fire shovel.....	1	3.05	
Poker.....	1	1.90	
Split broom.....	1	1.25	
Hand hammer.....	1	3.50	} In Box A, 5. 80.05 lbs.
Riveting hammer.....	1	1.05	
Nailing hammer.....	1	1.80	
Sledge hammer.....	1	10.50	
Chisels for hot iron.....	2	3.00	
Chisels for cold iron.....	2	3.00	
Smith's tongs.....	3	15.00	
Fore punch.....	1	1.00	
Creaser	1	1.00	
Fuller.....	1	2.40	
Nail claw.....	1	5.00	} In shoeing box. 12.75 lbs.
Round punch.....	1	2.10	
Tap wrench.....	1	3.75	
Die stock.....	1	6.25	
Nave bands, developed.....	4	11.75	
Tire bands, developed.....	2	2.75	
Shoeing hammer.....	1	0.82	
Pair pincers.....	1	2.00	
Rasps, (12 inches).....	2	2.15	
Shoeing knife.....	1	0.33	
Toe knife.....	1	0.30	} Fastened on inside of the chest cover with two copper clamps. On the chest. On its hook.
Pritchel.....	1	0.85	
Nail punch.....	1	0.80	
Clinching iron.....	1	1.00	
Oil stone	1	1.50	
Leather aprons.....	2	3.00	
Iron square.....	1	2.00	
Padlock	1	0.50	
Tar bucket.....	1	7.00	
Boxes.....	6	53.45	
Tow for packing.....	5.00	
Total.....	480.38	

CONTENTS OF THE FORGE BODY, A.

Box A, 6, of the same dimensions as A, 1, is carried in the iron room.

To put this box in, or take it out, loosen the thumb nuts and raise the rear of the bellows an inch.

TOOLS AND STORES.	No.	Weight.	Place.
		<i>lbs.</i>	
Water bucket, wood.....	1	10-00	On its hook.
Anvil	1	100-00	On the fire-place.
Vice	1	29-00	Fixed on the stock of the carriage.
Watering bucket, leather.....	1	8-00	On the vice.
Bituminous coal..... lbs.	250	250-00	} In the coal box.
Coal shovel	1	4-75	
Padlock	1	0-50	On coal box.
Horseshoes, Nos. 2 and 3.....lbs.	100	100-00	Box A, 6, in iron room.
Square iron, $\frac{1}{2}$ in. and $\frac{5}{8}$ in....lbs.	100	100-00	} In the iron room. The bars not more than 3 feet long; the square iron in 2 bundles.
Flat iron, $1\frac{1}{4}$ in. \times $\frac{5}{8}$ in., 1 in. \times $\frac{1}{2}$ in. and $1\frac{1}{2}$ in. \times $\frac{1}{4}$ in. lbs.	50	50-00	
Round iron, $\frac{3}{8}$ in.....lbs.	50	50-00	
Cast steel, $\frac{5}{8}$ in. square.....lbs.	5	5-00	
English blister steel..... lbs.	5	5-00	
Box.....	1	8-25	
Tow	2-00	
Total, exclusive of vice.....	693-50	

NOTE.—100 lbs. of horseshoes, assorted, contain 90 shoes.
1 lb. horseshoe nails, No. 3, contains 140 nails.
1 lb. horseshoe nails, No. 2, contains 112 nails.

To put the bellows in its place: Remove the coal box from the back of the bellows-house; take out the two stay plates at the lower ends of the rabbets in the braces; put the projecting ends of the upper bellows' arm in the rabbets, and slide them up until the ends of the lower arm come into their places; put on the stay plates, and fasten them down with the thumb nuts. Screw the brass elbow pipe into its place, through the hole in the sheet iron front of the bellows-house; put in the copper pipe, and screw up the collar which connects it with the elbow pipe.

Equipment of a Battery Wagon for a Field Battery.

INTERIOR ARRANGEMENT OF LIMBER CHEST.

The chest is marked: BATTERY WAGON, C.

The tools and stores are carried in *four boxes*, marked C, Nos. 1, 2, 3, and 4, respectively, and in *one oil can*.

The *boxes* are made of white pine $\cdot75$ inch thick, with leather handles inside, and loose covers, like those of the limber chest of Forge A.

The covers of Nos. 1 and 2 are $\cdot75$ inch thick; those of Nos. 3 and 4 are $\cdot5$ inch thick.

EXTERIOR DIMENSIONS OF THE BOXES.

DESIGNATION.	Length.	Width.	Depth.	Weight.
	<i>inches.</i>	<i>inches.</i>	<i>inches.</i>	<i>lbs.</i>
C, No. 1.....	17·8	13·25	7·5	8·25
C, No. 2.....	26·5	17·8	7·5	17·5
C, No. 3.....	39·8	9·8	6·25	12·5
C, No. 4.....	39·8	8·	6·25	11·

No. 3 has a partition, at 5·25 from one end for the oil can.

No. 4 has two partitions perpendicular to the sides, making three divisions 15·8 inches, 10 inches, and 11 inches long, respectively.

The *oil can* is like that for the limber chest of Forge A, and is marked: C, SPERM OIL.

Boxes Nos. 1 and 2 occupy the bottom of the chest; No. 1 against the left end.

Nos. 3 and 4 are placed on top of Nos. 1 and 2; No. 3 against the rear of the chest.

CONTENTS OF LIMBER CHEST FOR BATTERY WAGON, C.

TOOLS AND STORES.	No.	Weight.	Place.	
CARRIAGE-MAKER'S TOOLS.				
		<i>Lbs.</i>		
Hand saw.....	2	4-00	} Fastened to the inside of chest cover.	
Tenon saw, (14 in.)	1	1-50		
Jack plane.....	1	4-15		
Smoothing plane.....	1	1-80		
Brace, with 24 bits.....	1	4-35		
Spoke shave.....	1	0-30		
Gauge.....	1	0-30		
Plane irons	2	1-05		
Saw set.....	1	0-25		
Rule, (2 feet).....	1	0-14		
Gimlets.....	12	0-95		} In Box C, 1. 17-20 lbs.
Compasses.....pair.	1	0-18		
Chalk line	1	0-10		
Brad awls	2	0-17		
Scriber.....	1	0-15		
Saw files, (4½ in.).....	12	0-87		
Wood files, (10 in.).....	2	1-12		
Wood rasp, (10 in.)	1	0-40		
Trying square, (8 in.).....	1	0-60		
Hand screw-driver.....	1	0-32		
Oil stone.....	1	1-50	} In Box C, 2. 32-23 lbs.	
Broad axe	1	6-00		
Hand axe.....	1	5-00		
Claw hatchet.....	1	2-00		
Claw hammer	1	1-50		
Pincers, (small)	1	1-06		
Table vice	1	3-80		
Framing chisels, (1 in. and 2 in.)..	2	3-00		
Firmer chisels, (¾ in. and 1½ in.)..	2	1-00		
Framing gouges, (1 in. and 1½ in.)	2	2-60		
Augers and handles, (½ in., ⅝ in., and ¾ in.).....	3	2-35		
Screw wrench.....	1	2-42		
Felling axe } with handles.....	{ 1	6-00	} In Box C, 3. 23-25 lbs.	
Adze.....	{ 1	3-30		
Frame saw.....	1	4-50		
Quart can of sperm oil.....	1	2-70		
SADDLER'S TOOLS AND STORES.				
Mallet.....	1	1-75	} In Box C, 3. 23-25 lbs.	
Clam.....	1	5 00		
Carried forward.....		78-18		

LIMBER CHEST OF BATTERY WAGON, C—(Continued.)

TOOLS AND STORES.	No.	Weight.	Place.
Brought forward.....	<i>lbs.</i> 78-18	
SADDLER'S TOOLS AND STORES.			
Hammer.....	1	0-65	} In Box C, 4. 20-66 lbs.
Shoe knife.....	1	0-09	
Half round knife.....	1	0-28	
Shears.....pair.	1	0-47	
Sand stone.....	1	1-54	
Rule, (2 feet).....	1	0-14	
Needles.....	100	0-08	
Awls and handles.....	12	0-75	
Punches.....	2	0-22	
Pincers.....pair.	1	0-75	
Pliers.....pair.	1	0-22	
Claw tool.....	1	0-12	
Creaser.....	1	0-15	
Thimbles.....	4	0-06	
Strap awl.....	1	0-01	
Beeswax.....lbs.	2	2-00	
Black wax.....lbs.	3	3-00	
Bristles.....oz.	8	0-50	
Shoe thread.....lbs.	5	5-00	
Patent thread.....lbs.	2	2-00	
Buckles, (assorted, .75 in. to 1-5 in.).....doz.	3	1-00	
Tacks.....M.	3	0-75	
Gunner's callipers.....	1	0-50	
Shoe knives.....	2	0-18	
Scissors.....pairs.	2	0-20	
Padlock.....	1	0-50	} On its hook.
Tar bucket.....	1	7-00	
Boxes.....	4	49-25	
Tow for packing.....	7-00	
Total.....	162-59	

INTERIOR ARRANGEMENT OF WAGON BODY, C.

A TILL, 9 inches wide and 9·5 inches deep, is placed at the back or right side of the wagon body.

AN AXE RACK extends along the whole length of the body, on the left side, 11 inches from the bottom; it is 2 inches deep and 1·5 inches wide, and is fastened to the side by the middle rivets of the side studs, and by 5 wood screws. The rack has notches, to hold three axes, a hatchet, and three hand bills.

Four boxes, for stores, marked: C, Nos. 5, 6, 7, and 8.

One box, marked: C, CANDLES.

EXTERIOR DIMENSIONS OF BOXES FOR WAGON BODY, C.

DESIGNATION.	Length.	Width.	Depth.	Weight.	Remarks.
	<i>inches.</i>	<i>inches.</i>	<i>inches.</i>	<i>lbs.</i>	
C, Nos. 5 & 6	23·	18·5	11·25	17·5	No covers... } Of hard wood, 0·75 Loose cover. } inch thick. Div. into { White pine, 0·625 inch 4 parts { thick, with covers, hinges, and locks.
C, No. 7.....	23·5	20·25	14·	28·	
C, No. 8.....	13·	13·	5·	6·	
Candle box..	11·	6·5	5·5	2·85	

Seven tin cans; 2 marked: C, NEAT'S-FOOT OIL; 1 marked: C, LINSEED OIL; 1: C, TURPENTINE; 2: C, OLIVE PAINT; 1: C, BLACK PAINT.

DIMENSIONS OF CANS FOR WAGON BODY, C.

KIND.	Capacity.	Diam.	Height.	Weight.	Remarks.
		<i>in.</i>	<i>in.</i>	<i>lbs.</i>	
For neat's-foot oil.	2 gals.	8·	11·5	2·2	} Rounded tops and necks for corks.
For linseed oil and turpentine.	1 gal.	6·	10·	1·37	
For olive paint.....	25 lbs.	9·75	10·25	3·	} Flat tops; opening covered with a piece of tin, soldered on.
For black paint....	5 lbs.	7·	8·5	1·5	

Two kegs, for grease; exterior dimensions:

Diameter at the bilge.....	10·5 inches.
Diameter at the heads.....	9·75 "
Height.....	12·5 "
Weight.....	5 lbs.

CONTENTS OF THE WAGON BODY, C.

Box C, No. 5, is placed on the bottom of the wagon, next to the pile of harness which occupies the rear part of the body. Box No. 6 is on the top of No. 5; No. 7 on the bottom of the wagon, in front of No. 5; No. 8 on top of No. 7. The candle box in No. 6.

TOOLS AND STORES.	No.	Weight.	Place.
		<i>lbs.</i>	
Linseed oil.....gal.	1	9.17	In 1 tin can.
Spirits turpentine....gal.	1	8.77	" 1 do. } In Box C, 5.
Olive paint.....lbs.	50	56.	" 2 do. } 80.44 lbs.
Black paint.....lbs.	5	6.5	" 1 do. }
Paint brushes.....	12	3.00	} In candle box.
Spm. or wax candles, lbs.	5	7.85	
Rammer heads.....	4	2.90	
Sponge heads.....	4	3.20	
Sponges.....	12	3.00	
Priming wires.....	3	0.24	} In Box C, 6. 28.73 lbs.
Gunner's gimlets.....	3	0.24	
Lanyards for friction tubes.....	4	0.40	
Cannon Spikes.....	6	0.30	
Dark lanterns.....	3	3.	} In Box C, 7. 92.80 lbs.
Common lanterns.....	4	4.60	
Neat's-foot oil.....gals.	4	32.80	} In 2 tin cans. } In Box C, 7. " 2 kegs..... } 92.80 lbs.
Grease.....lbs.	50	60.	
Nails, (4d, 6d, 8d, 10d,) lbs.	20	20.	Box C, 8.
Felling axes.....	2	12.	} In the axe rack.
Claw hatchet.....	1	2.	
Hand bills.....	2	4.	
Caisson stock.....	1	35.	Under the till, against the side and rear of the wagon.
Rammers and sponges ...	3	13.5	On the caisson stock, against rear end.
Spokes.....	40	72.	On the bottom; piled lengthwise against the front end.
Fellies.....	24	160.	On the spokes, crosswise.
Grindstone, 14 in. X 4 in.	1	50.	} On the fellies, against the left side of the wagon.
Arbor and crank for do..	1	6.5	
Carried forward.....	576.97	

CONTENTS OF THE WAGON BODY, C—(Continued.)

TOOLS AND STORES.	No.	Weight.	Place.
Brought forward.....		<i>lbs.</i> 576·97	
Screw jacks.....	3	75	On the fellies, against the front and the till.
Wheel traces.....	10	47·5	} In a pile occupying 30 inches at the rear end of the wagon, between the left side and the caisson stock, and up to the top of the till; the collars piled on each other, from the bottom.
Leading traces.....	10	57·5	
Collars.....	6	27·5	
Girths.....	16	11	
Whips.....	16	8	
Bridles.....	6	18	
Halters.....	6	21	
Halter chains.....	12	15·5	
Hame straps.....	25	4·5	
Spare nose bags.....	12	13·5	} On the harness.
Sash cord..... pieces.	6	10	
Slow match..... yds.	50	6	On box No. 7, to the left of No. 8.
Elevating screw.....	1	15·75	} On the pile of harness.
Pole yoke.....	1	12·25	
Harness leather.....side.	1	25	} Under the till, in front of the pile of harness, and against the caisson stock.
Bridle leather.....do.	2	22	
Prolonge.....	1	18	On box No. 7, in front of No. 8.
Scythes.....	4	9	In the till, against the front end.
Scythe stones.....	4	6	In the curve of the scythes.
Spades.....	6	30	In the till; the bits against the rear end.
Pick axes and handles...	2	13	Between the spade handles.
Corn sacks.....	24	20	On the scythes.
Tarpaulins, 5 feet square.	2	18	On the corn sacks, against front end.
Reaping hooks.....	4	3·85	Fastened to the ridge pole with a wooden clamp and a leather strap.
Scythe snaths.....	4	12	Fastened to the ridge pole with two leather straps and buckles.
Spare stock for battery wagon.....	1	90	In the spare stock stirrup.
Padlock.....	1	0·5	
Watering bucket.....	1	8	Tied to the forage rack.
Forage.....	In the forage rack
Boxes.....	4	69	
Tow.....	24·5	
Total.....	1288·82	Exclusive of forage.

Spare gun-carriage stocks, splinter bars, axle-trees, etc. form parts of the equipments of Battery wagon D. When ordered on service beyond the reach of the field park, these articles, together with other spare parts which may be needed and cannot be readily made from ordinary material, such, for instance, as spare hounds, forks, middle and side rails, and cross-bars for caissons, assembling bars, spare lock chain, etc., should accompany the battery. (See *Ordnance Manual*.)

For other than ordinary repairs, resort must generally be had to the field park. For those occasioned by battle, which may be extensive, such resort is generally imperative, as the battery must be put in immediate order for service either in pursuit of an enemy, or to cover a retreat. When separated from the park, it is therefore necessary that the captain should see not only that his battery is provided with these parts, but that they are ironed and fitted, so that no time will be lost in completing his repairs.

COMPOSITION AND PREPARATION OF PAINTS.

Paint is generally furnished to batteries, mixed and ready for use. When not supplied, and the materials can be procured, paints may be prepared as follows:

The proportions are given for 100 parts by weight of prepared colors, etc., when not otherwise designated.

A gallon of linseed oil weighs.....	7.5 lbs.
Spirits of turpentine.	7.25 "
Japan varnish.	7. "
Sperm oil.....	7.12 "
Neat's-foot oil.....	7.63 "

Black Paint.

Lampblack.....	28
Litharge.....	1
Japan varnish.....	1
Linseed oil, boiled.....	73
Spirits turpentine.....	1

Grind the lampblack in oil; mix it with the oil, then grind the litharge in oil and add it, stirring it well into the mixture. The varnish and turpentine are added last. The paint is used for the iron-work of carriages.

Olive Paste.

Yellow ochre, pulverized	68·
Lampblack	1·1
Boiled oil	37·
Spirits turpentine	0·4

Make a thick paste with the ochre and oil, in a paint pot, and with the lampblack and oil in another; grind them together in small portions, and keep the mixture in a tin vessel.

Liquid Olive Color.

Olive paste	61·5
Boiled oil	29·5
Spirits turpentine	5·5
Dryings	3·5
Japan varnish	2·

Stirred together in a paint pot.

QUANTITY OF PAINT REQUIRED FOR A CARRIAGE.

KIND OF CARRIAGE.	Lead color.	Olive.	Black.
	<i>lbs.</i>	<i>lbs.</i>	<i>lbs.</i>
Field gun-carriage and limber, with implements..	6	10	0·75
Caisson, with limber and implements, etc.....	8	15	0·8
Forge, with limber.....	6	10	1·
Battery wagon, do.....	7	13	0·9
Casemate carriage and chassis, with implements..	7	14	0·75
Barbette carriage and chassis, with implements..	6	11	1·

A priming of lead color and 2 coats of olive color are applied to new wood-work, and 1 coat of lead color and 1 of black, to the iron-work.

Paint for Tarpaulins.

A square yard takes 2 pounds for 3 coats.

1.— <i>Olive.</i> —Liquid olive color.....	100
Beeswax.....	6
Spirits turpentine	6

Dissolve the beeswax in the spirits of turpentine, with a gentle heat, and mix the paint warm.

2.—Add 12 ounces of beeswax to 1 gallon of linseed oil, and boil it two hours; prime the cloth with this mixture, and use the same, in place of *boiled oil*, for mixing the paint. Give 2 coats of paint.

WEIGHTS OF FORGES AND BATTERY WAGONS EQUIPPED FOR
FIELD SERVICE.

DESIGNATION.	For the battery.	For the park.
FORGE.		
Body complete, without wheels.....	<i>lbs.</i> 997	<i>lbs.</i> 997
Two wheels.....	360	360
Anvil and water buckets	118	118
Stores in iron room.....	320	455
Stores in coal box	255	255
Limber body, without wheels.....	335	335
Two wheels.....	360	360
Limber chest, empty.....	158	158
Stores and tools on the limber.....	480	332
Total weight	3,383	3,370
BATTERY WAGON.		
Body complete, without wheels.....	<i>lbs.</i> 910	<i>lbs.</i> 910
Two wheels.....	360	360
Stores in wagon body.....	1,289	2,583
Limber body, without wheels	335	335
Two wheels	360	360
Limber chest, empty.....	158	158
Stores and tools on the limber	162	209
Total weight, (exclusive of forage,).....	3,574	4,915

HORSES.

The number of horses required in a battery varies with the description of the battery and the nature of its service. Under ordinary circumstances, when horses can be procured from the country in which the operations are conducted, or supplied from the depots, no greater number should be attached to the battery than experience has proved to be necessary to keep it efficient. The carriages should be kept fully and well horsed; for when one of a team is injured or inferior in strength, additional labor is thrown on the remainder unless he is at once replaced.

HORSES REQUIRED FOR A MOUNTED BATTERY OF SIX PIECES.

		12-pdr.	12-pdr. Light.	6-pdr.
Draught horses.	{ For battery of manœuvre, 12 carriages..	96	72	72
	{ " 6 additional caissons	36	36
	{ " 1 battery wagon.....	6	6	6
	{ " 1 travelling forge.....	6	6	6
	{ " spare 1-12 additional	12	10	7
Saddle horses.	{ " 8 sergeants	8	8	8
	{ " 6 artificers.....	6	6	6
	{ " 2 buglers.....	2	2	2
	{ " spare.....	3	3	3
Total number of horses.....		175	149	110

For service on the plains, at least one pair of spare draught horses to each carriage should be provided.

In horse artillery, the number of saddle horses required for the gun detachment, including spare ones, is 12 for each detachment, or 72 for a six-gun battery.

HORSE EQUIPMENTS.

The number of sets of horse equipments will correspond with the number of mounted men in the battery, exclusive of drivers.

ARTILLERY HARNESS.

(PLATE 18.) The construction of the field carriages requires a harness different, in some respects, from that of common wagons. The limber having no sweep bar, the pole is supported directly by the wheel horses, by means of a chain, which connects the hames with the *pole-yoke* of the limber; and in order to diminish the weight at the end of the pole, the leading bars are dispensed with, the traces of the leaders being attached to those of the wheel horses. The position of the limber chest over the axle is such that, when loaded, it further diminishes the weight at the end of the pole.

HARNESS REQUIRED FOR EACH HORSE.

	WHEEL.		LEAD.		Weight.
	Near.	Off.	Near.	Off.	
Halter.....	1	1	1	1	3·5
Bridle.....	1	1	1	1	3·5
Driver's saddle.....	1	1	17·5
Valise saddle and valise.....	1	1	13·
Collar and harness.....	1	1	1	1	16
Pair of traces... { Wheel.....	1	1	9·5
{ Lead.....	1	1	11·5
Trace loops and belly-band.....	1	1	1	1	1·
Loin straps and trace loops { Wheel...	1	1	1·
{ Lead.....	1	1	1·
Crupper.....	1	1	1	1	0·75
Breeching, hip strap and breast strap.....	1	1	8·5
Leg guard.....	1	2·25
Whip.....	1	1	0·5
Nose-bag.....	1	1	1	1	1·15
Pole strap.....	1	1	2·
	<i>lbs.</i>	<i>lbs.</i>	<i>lbs.</i>	<i>lbs.</i>	
WEIGHT.... { For each horse.....	67·15	59·9	56·4	51·4	
{ Set for 2 horses.....	127·05		107·8		

D

ARTICLE THIRD.

POINTING AND RANGES.

To point a piece, is to place it in such a position that the shot may reach the object it is intended to strike. To do this, the axis of the trunnions, being horizontal, the line of metal, called also the natural line of sight, must be so directed as to pass through the object, and then the elevation given to the piece to throw the shot the required distance. The *direction* is given from the trail, and the *elevation* from the breech; the trail being traversed by a handspike, and the breech raised or depressed by an elevating screw.

The axis of the piece coincides with that of the cylinder of the bore.

The line of sight in pointing is the line of direction from the eye to the object. It lies in a vertical plane, passing through, or parallel to the axis of the piece.

The angle of sight is the angle which the line of sight makes with the axis of the piece.

The natural line of sight is the straight line passing through the highest points of the base ring, and the swell of the muzzle, muzzle sight, or muzzle band.

The natural angle of sight is the angle which the *natural* line of sight makes with the axis of the piece.

The dispart of a piece, is half the difference between the diameters of the base ring and swell of the muzzle, or the muzzle band. It is therefore the tangent of the natural angle of sight, to a radius equal to the distance from the highest point of the swell of the muzzle or muzzle band, to the plane passing through the rear of the base ring.

By range is commonly meant the distance between the piece and the object which the ball is intended to strike; or, the first graze of the ball upon the horizontal plane on which the carriage

stands. **Point-blank range** is the distance between the piece and the point-blank. **Extreme range** is the distance between the piece and the spot where the ball finally rests.

Theory of pointing. *The point-blank* is the second point of intersection of the trajectory or curve described by the projectile in its flight with the line of sight. As the angle of sight is increased, the projectile is thrown farther above the line of sight, and the trajectory and point-blank distance becomes more extended.

The point-blank range increases with the *velocity*, the *diameter* and the *density* of the ball. It is also affected by the inclination of the line of sight; but with the angles of elevation used in field service, this effect is too small to be taken into account.

A piece is said to be aimed *point-blank* when the line of metal, which is the natural line of sight, is directed upon the object. This must be the case when the object is at point-blank distance. When at a greater distance the pendulum-hausse, or the tangent scale, is raised upon the breech until the sight is at the height which the degree of elevation for the distance may require. An artificial line of sight, and an *artificial* point-blank are thus obtained, and the piece is aimed as before.

The different lines, angles, etc., which an artilleryman has to take into account in pointing, will be best understood by the following figure :

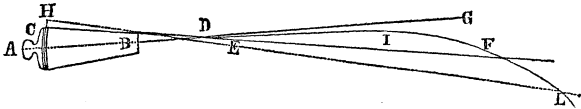

A B is the axis of the piece. B I F L is the trajectory or curve described by the projectile in its flight. C D F is the natural line of sight. C D A is the natural angle of sight.

The projectile, thrown in the direction of the axis A B D G, is acted upon by the force of gravity, and begins to fall at once below the line at the rate of $16\frac{1}{2}$ feet for one second, $64\frac{1}{3}$ for two, $144\frac{3}{4}$ for three, and so on in proportion to the time. It cuts the line of sight at D, a short distance from the muzzle of

the piece, and descending, again cuts it at the point F. This second point of intersection is the *point-blank*.

Pendulum-hausse. The instrument at present in most general use in pointing field guns at objects beyond the natural point-blank, is called a *pendulum-hausse*, of which the component parts are denominated the *scale*, the *slider*, and the *seat*. The *scale* is made of sheet brass: at the lower end is a brass bulb filled with lead. The *slider* is of thin brass, and is retained in any desired position on the scale by means of a brass set screw with a milled head. The scale is passed through a slit in a piece of steel, with which it is connected by a brass screw, forming a pivot on which the scale can vibrate laterally: this slit is made long enough to allow the scale to take a vertical position in any *ordinary* cases of inequality of the ground on which the wheels of the carriage may stand. The ends of this piece of steel form two journals, by means of which the scale is supported on the *seat* attached to the piece, and is at liberty to vibrate in the direction of the axis of the piece. The *seat* is of iron, and is fastened to the base of the breech by three screws, in such manner that the centres of the two journal notches shall be at a distance from the axis equal to the radius of the base ring.

A *muzzle sight* of iron is screwed into the swell of the muzzle of *guns*, or into the middle of the muzzle ring of *howitzers*. The height of this sight is equal to the *dispart* of the piece, so that a line from the *top* of the muzzle sight to the *pivot* of the scale is parallel to the axis of the piece. Consequently the vertical plane of sight passing through the centre line of the scale and the top of the muzzle sight will be also parallel to the axis in any position of the piece: the scale will therefore always indicate correctly the angle which the line of sight makes with the axis. The *seat* for suspending the *hausse* upon the piece is adapted to each piece according to the varying inclination of the base of the breech to the axis. The *hausse*, the *seat*, and the *muzzle sight*, varying as they do, in their construction and arrangement, according to the configuration of the piece upon which they are intended to be used, are marked for the kind of piece to which they belong. The graduations on the scale are the tangents of each quarter of

a degree, to a radius equal to the distance between the muzzle sight and the centre of the journal-notches, which are, in all cases, one inch in rear of the base ring.

The hausse, when not in use, is carried by the gunner in a leather pouch, suspended from a shoulder strap.

PRACTICAL HINTS ON POINTING.

As it is impossible to point a piece correctly without knowing the *distance* of the object, artillerymen should be frequently practiced in estimating distances by the eye alone, and verifying the estimate afterwards, either by pacing the distance, or by actual measurement with a tape-line or chain, until they acquire the habit of estimating them correctly.

Shells are intended to burst *in* the object aimed at: **spherical case shot** are intended to burst from fifty to seventy-five yards short of it.

Shell or spherical case firing, for long ranges, is less accurate than that of solid shot.

At high elevations a solid shot will range farther than a shell or spherical case shot of the same diameter fired with an equal charge. But at low elevations, the shell or spherical case will have a greater initial velocity, and a longer range. If, however, the charges be proportioned to the weights of the projectiles, the solid shot will in all cases have the longest range.

The velocity or range of a shot is not affected in any appreciable degree by checking the recoil of the carriage, by using a tight wad, or by different degrees of ramming.

The principal causes which disturb the true flight of the projectile may be simply stated as follows :

1st. If the wheels of the carriage are not upon the same horizontal plane, the projectile will deviate towards the *lowest* side of the carriage.

2d. If the direction of the wind is across the line of fire, deviations in the flight of the projectile will be occasioned, and in proportion to the strength of the wind, the angle its direction makes with the line of fire, and the velocity of the projectile.

3d. If the centre of gravity of the projectile be not coincident with the centre of figure, the projectile will deviate towards the *heaviest side*, that is, in the same direction that the centre of gravity of the projectile, while resting in the piece, lies with regard to the centre of figure. Therefore, if a shot be placed in the piece so that its centre of gravity is to the *right* of the centre of the ball, the shot will deviate towards the *right*; and vice versa. If the centre of gravity be above the centre of figure, the range will be *increased*; if *below*, it will be diminished.

Should an enemy's cavalry be at a distance of 1000 yards from the battery it is about to charge, it will move over the first 400 yards at a walk, approaching to a gentle trot, in about four and a half minutes; it passes over the next 400 yards at a round trot, in a little more than two minutes; and over the last 200 yards at a gallop, in about half a minute, the passage over the whole distance requiring about seven minutes. This estimate will generally be very near the truth, as the ground is not always even, nor easy to move over. Many losses arise from the fire of the artillery and from accidents, and the forming, and filling up of intervals create disorder; all of which contribute to retard the charge. Now a piece can throw with sufficient deliberation for pointing, two solid shot or three canisters per minute. Each piece of the battery, therefore, might fire nine rounds of solid shot upon the cavalry whilst it is passing over the first 400 yards; two rounds of solid shot and three of canister whilst it is passing over the next 400 yards; and two rounds of canister whilst passing over the last 200 yards—making a total from each gun of eleven round shot and five canisters. To this is added the fire of the supporting infantry.

Care should be taken not to cease firing solid shot too soon, in order to commence with canister. If the effect of the latter be very great on hard, horizontal, or smooth ground, which is without obstruction of any kind, it is less in irregular and soft ground, or on that covered with brushwood; for, if the ground be not favorable, a large portion of the canister shot is intercepted. A solid shot is true to its direction, and, in ricochet, may hit the second line if it misses the first.

Solid shot should be used from 350 yards upwards: the use of canister should begin at 350 yards, and the rapidity of the fire increase as the range diminishes. In emergencies, double charges of canister may be used at 150 or 160 yards, with a single cartridge.

Spherical case ought not, as a general rule, to be used for a less range than 500 yards; and neither spherical case nor shells should be fired at rapidly advancing bodies, as for instance, cavalry charging.

The fire of spherical case and of shells on bodies of cavalry in line or column, and in position, is often very effective. To the destructive effects of the projectiles are added the confusion and disorder occasioned amongst the horses by the noise of their explosion; but neither shells nor spherical case should be fired so rapidly as solid shot.

In case of necessity, solid shot may be fired from howitzers.

RANGES OF FIELD GUNS AND HOWITZERS.

The range of a shot or shell in this table is the distance from the piece to the point at which the first graze of the ball is made on horizontal ground, the piece being mounted on its appropriate field carriage.

The range of a spherical case shot is the distance at which the shot bursts near the ground in the time given, thus showing the elevation, and the length of fuze required for certain distances.

DESCRIPTION OF PIECE.	Charge.	Projectile.	Elevation.	Range.	Remarks.	
6-PDR. GUN.....	<i>lbs.</i> 1·25	Shot.	0 /	<i>yards.</i> 320		
			1	675		
			“	870		
			“	1,140		
			“	1,250		
			“	1,525		
	1·25	Sph. case shot.				

RANGES OF FIELD GUNS AND HOWITZERS—(Continued.)

DESCRIPTION OF PIECE.	Charge.	Projectile.	Elevation.	Range.	Remarks.	
LIGHT 12-PDR. GUN..	lbs. 2·5	Shot.	° / 0	yards. 325		
		“	1	620		
		“	2	875		
		“	3	1,200		
		“	4	1,320		
		“	5	1,680		
	2·5	Sph. case shot.	0 30	300	Time 1 second.	
		“	1	560	“ 1 $\frac{3}{4}$ “	
		“	1 30	700	“ 2 $\frac{1}{4}$ “	
		“	2	730	“ 3 “	
		“	3	960	“ 4 “	
LIGHT 12-PDR. GUN..	2·5	Shell.	0	300	Time $\frac{3}{4}$ second.	
		“	30	425	“ 1 $\frac{1}{4}$ “	
		“	1	625	“ 1 $\frac{3}{4}$ “	
		“	1 30	700	“ 2 $\frac{1}{4}$ “	
		“	2	775	“ 2 $\frac{1}{2}$ “	
		“	2 30	925	“ 3 $\frac{1}{4}$ “	
		“	3	1,075	“ 4 “	
“	3 45	1,300	“ 5 “			
12-PDR. GUN.....	2·5	Shot.	0	350		
		“	1	660		
		“	1 30	780		
		“	2	900		
		“	3	1,270		
		“	4	1,450		
	2·5	Sph. case shot.				

RANGES OF FIELD GUNS AND HOWITZERS—(Continued.)

DESCRIPTION OF PIECE.	Charge.	Projectile.	Elevation.	Range.	Remarks.	
12-PDR. HOWITZER...	1.	Shell.	0	yards. 200		
		"	1	540		
		"	2	640		
		"	3	840		
		"	4	975		
	"	5	1,070			
	1.25	Sph. case shot.				
24-PDR. HOWITZER...	2.	Shell.	0	300		
		"	1	500		
		"	2	800		
		"	3	975		
		"	4	1,275		
	"	5	1,325			
	2.5	Sph. case	1 30	600		Time 2 seconds.
			1 45	700		" 2 $\frac{1}{4}$ "
			2 15	800		" 3 "
			2 45	900		" 3 $\frac{1}{2}$ "
			3 15	1,000		" 4 "
3 30			1,100	" 4 $\frac{1}{2}$ "		
32-PDR. HOWITZER...	2.5	Shell.	0	290		
		"	1	530		
		"	2	780		
		"	3	1,030		
		"	4	1,200		
	"	5	1,500			
	3.25	Sph. case	1 30	600		Time 2 seconds.
			1 45	700		" 2 $\frac{1}{4}$ "
			2 15	800		" 3 "
			2 45	900		" 3 $\frac{1}{2}$ "
			3	1,000		" 3 $\frac{3}{4}$ "
3 30			1,100	" 4 $\frac{1}{4}$ "		

NOTE.—All the ranges for the spherical case shot, with the present charges, have not yet been determined. See Ordnance Manual, new edition, soon to be published.

ARTICLE FOURTH.

INTERIOR ECONOMY AND MANAGEMENT OF A
BATTERY.

ARTILLERY HORSES.

ARTILLERY officers should make themselves thoroughly acquainted with the natural history of the horse, and the effects of different modes of treatment, changes of diet, etc. on his system, and powers of endurance. In the field the horse is subjected to so many privations, exposures, changes of food and water, etc., that an officer deficient in such knowledge will either have his battery constantly lacking in efficiency and reliability, or else make large expenditures necessary to provide remounts. Officers should also make themselves acquainted with the best methods of breaking and training horses.

Artillery horses are required for quick draught; they should move the carriage, ordinarily, rather by the weight thrown into the collar than by muscular exertion.

Description. Age at date of purchase 5 to 7 years: height, 15 hands 3 inches, allowing a variation of 1 inch. They should be well broken to harness, free from vice, perfectly sound in every respect, full chested, shoulders sufficiently broad to support the collar, but not too heavy: full barrelled, with broad deep loins; short coupled, with solid hind quarters; and their weight as great as is consistent with activity, say from 1100 to 1200 pounds when in good condition. In purchasing, special attention should be directed to the feet, to see that they are perfectly sound, and in good order, with hoofs rather large, and that the horse submits willingly to be shod.

Long-legged, loose-jointed, long-bodied, or narrow-chested horses should be at once rejected, as also those which are restive, vicious, or *too free* in harness.

A draught horse can draw 1600 pounds 23 miles a day, weight of carriage included. Artillery horses should not be required to draw more than 600 pounds each, including the weight of the carriage, but excluding that of the cannoneers.

A horse travels the distance of 400 yards at a walk, in $4\frac{1}{2}$ minutes; at a trot, in 2 minutes; at a gallop, in 1 minute. He occupies in the ranks a front of 40 inches, and a depth of 10 feet; in a stall, a front of 5 feet; at the picket, a front of 3 feet, and a depth of 9 feet. Stalls for artillery stables should be 6 feet wide.

FORAGE.

The daily allowance of oats, barley, and corn is 12 pounds; that of hay, 14 pounds; that of straw for bedding, 100 pounds per month.

The average weight of good oats is 40 pounds to the bushel; of barley, 48 pounds; of corn, 56 pounds.

The standard bushel of the United States contains 2150·4 cubic inches.

A cubic yard contains 21·69 bushels.

A box $16 \times 16\cdot8 \times 8$ inches, contains 1 bushel.

A box $12 \times 11\cdot2 \times 8$ inches, contains half a bushel.

A box $8 \times 8\cdot4 \times 8$ inches, contains 1 peck.

Pressed hay weighs 11 pounds per cubic foot.

Captains of batteries ordered for service on the plains should endeavor to secure daily issues, however small, of grain forage for the *draught* horses. The labor is excessive, particularly when there are no beaten roads, and is destructive to harnessed horses, which cannot, like saddle horses, be relieved by being dismounted and led for a portion of each day's march: neither can they graze during short halts for rest. Their daily marches are often longer than those of cavalry horses, as they must make detours to head ravines, and avoid other bad grounds which led horses can readily pass over. In a country intersected by steep hills and ravines, teams must often be doubled, thus doubling their labor and consuming time, where cavalry finds no difficulty. Average daily marches at the natural rates are, for *infantry*, 15 miles, performed

in six hours : for *cavalry*, 17 miles in six hours : for *artillery*, 16 miles in ten hours. These distances are given for bodies of troops on the march, each arm moving at its natural rate, in an ordinary country ; and the disadvantages of the artillery, as compared with the other arms, are of course greatly increased when troops operate on plains destitute of roads. If a battery is made to conform its movements to those of infantry or cavalry marching freely, its horses are greatly fatigued by moving at an unnatural gait. If it marches at its own rate, the horses are much longer on the road for equal distances, and have less time for grazing. Besides, if a horse breaks down, more labor is thrown on the rest of the team. Yet, in case of action, the movements must be rapid if the guns are expected to keep up with mounted Indians. Grain should therefore be issued regularly to them, and their strength preserved and economized so far as the nature of this species of service—which is foreign to the object, and unsuitable to the character of artillery duties—will permit.

WATER.

The daily allowance for a horse is 4 gallons. Pure, soft running water is the best. When drawn from wells in warm weather, it should, if practicable, be allowed to stand until the chill is taken off before being given to the horses. If this is not practicable, a handful of meal or bran, if it can be procured, should be thrown into each bucket of water.

Leather buckets are provided for watering horses on a march. When the water is drawn from wells, or has to be dipped from a stream, much time is consumed in the operation ; it would therefore be well to have one bucket for each pair of horses. These buckets form part of the equipment of the carriages, and the chief of each carriage is responsible to the chief of the piece that they are returned and properly secured after being used.

GENERAL RULES FOR STABLE MANAGEMENT.

The following general rules having been tested by experience, and found to be convenient, are recommended :—

1. The stable guard will consist of not less than three men and a non-commissioned officer. This guard is responsible for the police and order of the stables between stable calls.

2. The stable guard and the stable duty are under the direction of the battery officer of the day, the first sergeant, and the stable sergeant.

3. The men habitually groom their own horses, superintended by their chiefs of pieces. Supernumerary horses may be groomed by recruits, carefully supervised and instructed. The horses of chiefs of pieces are groomed by men of their commands.

4. The horses should be stalled according to their positions in the battery, the teams nearest the doors to be led out first. Their places at the picket rope will be in accordance with the same rule.

5. The grooming should always be at the picket rope, unless in stormy weather; if done in the stalls, the wisp and brush alone should be used.

6. To strike a horse whilst at the picket rope, or in the stall, is apt to make him vicious; it is strictly prohibited.

7. Horses require gentle treatment. Docile, but bold horses, may be excited to retaliate upon those who abuse them, whereas persistent kindness has often reclaimed vicious ones.

8. Each horse of a team should be groomed about twenty minutes, then at the signal "Lead up," the chief of each piece inspects his horses successively, exacting that the rules laid down under the head of "Grooming" shall have been strictly complied with; if not, the horse is to be taken back to the picket.

9. At morning stable call, the stable guard, assisted by supernumerary men, police the stables, take up the bedding, (separating that which is soiled for the manure heap,) the remainder to be put out on racks to dry. The stalls are then swept out and the mangers cleaned.

10. The grain may be put in each bin by the stable guard. A box on wheels for the oats is moved in front of the stall, and two allowance measures enables the distribution to be made with rapidity. The hay is fed by the stable men after their horses are led in, receiving it from the stable sergeant. If practicable, the

oats are to be fanned and the hay shaken before being given to the horses.

11. At the afternoon stable call, when the horses have left the stalls, the stable is policed and the bedding laid down, fresh clean straw being spread on the top of the old. Great care should be taken that the bed be not in ridges, but soft and even, the thickest part towards the head of the stall. The feeding to be the same as in the morning.

12. The watering is usually done from troughs; but after severe exercise and at noon in hot weather, buckets are preferable, it then being necessary to limit the horse's allowance. The horses are to be led at a walk to and from water.

13. Should it be found that a horse has neglected his feed, or refuses his water, it will at once be reported to the stable sergeant.

14. A non-commissioned officer of the stable guard should inspect the stables at least once in every two hours during the night; any appearance of sickness in a horse should be immediately made known to the stable sergeant.

15. The sickness of a horse, and the treatment he receives, should constitute part of the report of the battery officer of the day, to be recorded in a book kept for that purpose.

GROOMING.

The wisp, the curry-comb, and the brush are the implements used.

1. The wisp is to be used when the horses come in warm from exercise, and the horse is rubbed until dry, from his hind quarters against the hair up to his head.

2. The curry-comb is used when the horse is dry, beginning always on the near side at the hind quarters, its application being in proportion to the length and foulness of the coat; that is, if the coat is close, long, full of dust, and very filthy, use it freely to loosen the coat or the sweat that is dried and fast on the skin and roots of the hair, appearing like a white saltish dust.

In the spring of the year the curry-comb should, whilst the coat is changing, be used judiciously, as a removal of the hair

too rapidly, exposes the horses to the sudden changes of temperature. Proceeding from the hind quarters, descend to the quarters, minding not to scratch or injure the horse. The legs below the houghs are not to be touched with the curry-comb unless the dirt is matted on the joints of the hough, which may be carefully loosened with the curry-comb. The comb works unpleasantly on that part, and must be handled lightly.

Next proceed to the fetlocks, back, loins, flank, belly, shoulders, arms, chest, and neck, omitting no part that the curry-comb can be conveniently applied to; but tender places, thin of hair, or rubbed by the harness, need not be touched; they should be rubbed with the wisp. Observe, therefore, to begin with the curry-comb on the near hind quarters and finish with the head, keeping the comb in the right hand. After currying the near side, proceed with the off side: here use the left hand. This done, wisp off those places not touched by the curry-comb; then use the brush. Begin first at the head on the near side, taking the brush in the left hand and the curry-comb in the right; brushing more particularly those parts where the dust is more apt to lodge, proceed down the neck. The scurf of the neck next the head, and the scrag next the mane are difficult to clean. Apply the brush backward and forward on these places, finishing by leaving the coat smooth.

Clear the brush from dust after every two or three strokes with the curry-comb. Proceed in the reverse order used by the curry-comb, taking in those parts not touched by the curry-comb, viz., under the chest between the forelegs, the inside of the elbow or arm, and the parts about the fetlocks.

The skin under the flank and between the hind quarters must be free from dust, soft, and so clean as not to soil a white cloth.

The curry-comb begins at the hind quarters, and ends at the head.

The brush begins at the head, and, taking in all parts of the horse, ends at the quarters.

ARTICLE FIFTH.

FIELD SERVICE.

MARCHES.

THE front of a column should not be frequently diminished and increased on a long march, as it unavoidably increases the fatigue of the column, particularly the rear of it: when, therefore, the front is diminished, it should not be increased until there is a probability that it will not be necessary to diminish it again for some time.

The detachments should be told off into two parties, one for the piece, the other for the caisson, in order to give their assistance in holding on, or whenever it may be required on the march, etc.

The officers commanding sections, in order to preserve them in place, will, without waiting for express instructions, give such orders as may be necessary for holding on in descents, for assisting horses out of difficulties, for the passage of obstacles, etc.

Artificers should always be carried on a march, as their duties commence when that of the other men may be said to end, and, if fatigued with marching, they cannot be expected to work with alacrity or efficiency, however willing.

An intelligent non-commissioned officer should be sent to reconnoitre the road or ground that artillery is to pass over, and, when necessary, to report the state of it. When the march is connected with military operations, an officer should be employed for this duty.

The distance of two yards between the carriages should always be maintained on the best roads, to prevent fatigue and unnecessary stoppage to the horses. In bad or difficult roads, it may be necessary to increase the distance to four yards or more, according to the nature of the ground. Even infantry, under such

circumstances, open out and lose distance; with artillery it is unavoidable, and the horses suffer much from being alternately checked and urged on.

The strictest attention, however, should be constantly paid to the preservation of distances; not opening out more than is absolutely necessary. The loss of distances with small bodies of artillery may be made up; but with large bodies, or when acting with infantry, this cannot be done without serious disadvantage, particularly to the infantry; therefore, this point cannot be too strongly insisted upon, as being one of essential consequence.

Officers commanding sections should frequently halt to see that their carriages are well up, and marching in proper order.

When an accident happens to a carriage, it should, if possible, be drawn out of the column, so as not to interrupt the march of the other carriages or troops. The carriages in its rear must pass it by the most convenient flank, and close to proper distance. The disabled carriage resumes its position as soon as the damage is repaired; when the road is narrow, it must fall into the first interval it finds, and use every opportunity afforded by a wider space to regain its proper place.

A caisson belonging to a disabled piece must remain with it; a piece, however, should not remain with its disabled caisson, but merely leave a sufficient number of men to repair it.

When it is necessary to move a carriage along a slope, where a small jerk may overturn it, a drag rope should be fastened to the lowest side of the carriage, passed over the top of it, and held by two or three men, marching on the upper side of the slope; a small effort by these means will prevent a carriage from overturning on a very steep slope.

Whenever the ruts are very deep, the carriages must quarter the road; when however the road is narrow and sunk between banks, the horses should be left to themselves and not hurried. In such circumstances a skilful driver will save his horses much, particularly the wheel horses.

In passing over deep furrows, or small ditches or drains, the

carriages should cross them obliquely; when they are crossed perpendicularly, the horses not only encounter greater difficulty, but they, as well as the harness, suffer much from the jerks. The former line of march should be resumed as soon as they are passed.

When the roads are good or even tolerable, the artillery is always obliged to wait for infantry, which is attended with much additional fatigue to the horses, from having the harness so much longer upon them. When, therefore, there is no danger, the artillery should be allowed to regulate its own rate of marching.

On ordinary marches the detachments may be in front, rear, right, or left of their respective pieces; or they may all be in front or rear of the column of carriages, as the circumstances may require. But when the detachments are thus separated from their carriages, one man should march with each.

The preservation of horses is an important duty of an artillery officer.

The greatest care should be given to the fitting of the saddles and collars.

Sore backs and galled shoulders arise chiefly from neglect on the march. By prompt attention on the part of the officers, many horses may be preserved for service which would otherwise be disabled for months. The drivers must never be suffered to lounge or sit uneven on their saddles. A folded blanket under the saddle, is the best preventive of sore backs, as it adapts the shape of the saddle to any loss of flesh in the horse.

Every driver should have attached to his harness a pair of pads of soft leather, about six inches by four, stuffed with hair; basil leather is the best for this purpose.

The moment any tenderness is perceived in a horse's shoulders, the pressure must be removed by placing the pads under the collar above and below the tender part.

When a battery arrives in camp, quarters, or a cantonment, each non-commissioned officer will immediately examine every part of the carriage under his charge, especially the wheels, to the greasing of which he must attend: he will report to the

officer of his section, who reports to the commander of the battery. All damages must be repaired without delay.

The best grease for wheels is coarse sweet oil and tallow, (in equal parts melted together;) next to that, old soft lard. When these cannot be procured, slush may be used. Black-lead should be mixed with the grease.

The drivers must immediately report to the non-commissioned officers of their carriages any loss or breakage of their harness, and also any gall or other hurt which may have happened to their horses; any neglect on this point must be punished. In camp, greasy heels are the most common disability with which horses are affected; as these proceed from cold, occasioning humors to settle, the best preventive is hand rubbing and exercise to keep up a circulation.

Unless for some particular purpose, the elevating screws should never be raised higher than half their length: on a march they must be covered with a piece of canvas, or old flannel cartridge bag, to prevent their being clogged with dirt.

The pintle hooks and lunettes should be greased previous to marching.

If a battery is parked in hot weather, the naves of the wheels must be protected as much as possible from the effect of the sun, by sods, tarpaulings, or other covering.

ASCENTS.

If the ascent be long and steep, the road in a bad state, or, if from any other cause, the exertion of the horses is likely to be great, a part of the carriages should halt, the leaders of them be hitched on to those in front, and, when they arrive at the top, be sent back with as many more leaders as may be necessary.

Whatever may be the difficulties of the road, not more than ten horses can be hitched with effect to the same carriage; beyond this number, and even with it, it is difficult to make the horses pull together.

It may be sometimes necessary to make the detachments assist with bricoles or drag ropes.

After going up a short steep hill the horses should be halted; but when that cannot be done, they should be made to move slowly to allow them to recover their wind.

In going up a hill, carriages may be halted to rest the horses by bringing them across it, and locking the limbers or chocking the wheels. For this purpose it may be advisable to divide the carriages into portions of three or four each, starting them from the bottom in succession, with an interval of twenty or thirty yards, or more, between each portion.

DESCENTS.

The drivers should never dismount in going down hill. The wheel driver holds his near horse well in hand, and his off horse very short; the other drivers barely stretch their traces.

In descending steep hills the cannoneers must hold on. For this purpose, previous to marching off, the end of a drag rope is passed twice round the tulip of the piece, and the running part passed into the hook and pulled tight; the rope is then wound round the muzzle, or formed into a small coil and hung on it.

At the caisson the drag rope is fastened to one of the hind irons, or to the hind axletree. With a light battery, holding on will generally be sufficient; but, if necessary, the wheels must also be locked.

In steep and difficult descents the wheel horses only are left in the carriage, the others being taken out and led in rear; the cannoneers hold on with drag ropes.

When it is necessary to lock, the middle driver, or with four horses the leading one, dismounts for that purpose. Should there be a ditch, or other dangerous part on the side of the road, the wheel towards that side is locked in preference to the other.

TO CROSS SWAMPY GROUND.

Each carriage should preserve a distance of ten or twelve yards from its file leader, to prevent its being halted. An officer or non-commissioned officer should be posted where the ground pre-

sents the greatest difficulty, to instruct the drivers how to conduct their teams. The horses must be made to draw freely and quicken the gait. If the ground is very miry it may be necessary to assist with drag ropes, or even to use them alone, crossing the teams separately.

TO PASS A DITCH.

The prolonge must be fixed and the handspike taken out. If the ditch be a difficult one, the horses are halted at the edge of it, and the piece is run by hand close to the limber, which then proceeds gently until the piece is at the bottom of the ditch, when it moves quickly until the piece is out. Should the ditch be narrow it may be necessary to cut down the edges and hold on with drag ropes. If in passing over, the trail sinks into the ground, it must be disengaged by a drag rope fixed to it, or by the handspike.

CROSSING FORDS.

When the water is deep and the current strong, great attention must be paid in fording. The person conducting a column over a direct ford, should keep his eyes steadily fixed on some object on the opposite bank, which marks the place of going out. He must not look at the stream, which would deceive him by appearing to carry him down.

All those in rear should keep their eyes on those in front.

In order to resist the power of the stream, it is necessary to wade rather against it.

When the bottom of the ford, or the bank on the opposite side is bad, the leaders of the rear carriages should be hitched to those in front, and an officer stationed at the entrance, and another at the place of going out. The former causes the distances to be observed, and directs the drivers as to the manner of crossing the ford, and the latter directs them in their leaving it.

The management of the horses and the regulation of their gaits, are the same as prescribed for crossing swampy ground. Above all things, the horses must not be allowed to drink, halt, or trot either in passing the ford or in leaving it. If, however, the

stream to be forded is small, and neither deep nor rapid, and there are no troops immediately in rear, this opportunity of watering the horses, or, at least, of giving them a mouthful of water may be embraced.

The passage should be effected with as large a front as possible. After reaching the opposite bank, the leading carriages should move on to such distance from the ford as not to impede those in rear.

If the ford is not well known, it must be examined, and the dangerous places well marked, before the carriages attempt to cross.

Artillery carriages can pass a ford three feet and one-third deep; and this depth may be attempted when the ammunition boxes are perfectly water tight, or means have been taken to raise them sufficiently high; although much depends upon the bottom and the strength of the current.

When the ammunition boxes are not water tight, and are at their usual height of two feet ten inches above the ground, the depth attempted should not exceed two feet four inches.

PASSAGE OF MILITARY BRIDGES.

At the entrance of the bridge all but the wheel drivers dismount; the dismounted drivers march at their horses' heads, holding the reins of the near horse with the right hand near the bit. A distance of twenty yards is kept between the carriages. The gait must be free and decided, and the drivers should conduct the carriages as near the middle of the flooring as possible; if the flooring is wet, they must attend particularly to keeping the horses from slipping. Battens should, in this case, be nailed across the bridge. It may sometimes be necessary to pass the carriages and horses separately.

There should be no halt on the bridge. Whenever it is perceived to rock, the passage of the troops must be stopped. If the bridge cracks under a carriage, it should increase its gait and pass as quickly as possible.

In passing over a flying bridge the drivers hold the horses,

facing towards them; it may occasionally be advisable to take the horses out; and in boisterous weather, or at night, the wheels should be locked.

PASSAGE ON ICE.

Ice 2 inches thick will bear infantry.

4 " " cavalry or light guns.

6 " " heavy field guns.

8 " " 24-pounder gun on sledges; weight

not over 1000 pounds to the square foot.

REVERSING A BATTERY IN A NARROW ROAD.

All the carriages should be drawn close to one side of the road, and the pieces and caissons unlimbered and reversed. The limbers are then brought in front of their carriages, which are then to be limbered up. If there is not room to reverse the limbers, the horses must be taken out.

Should this road be so narrow that the limbers cannot pass their carriages, the trails of the pieces and stocks of the caissons must be brought into a direction perpendicular to the road; if it has a bank on either side, the wheels must run close to the bank, and the trails and stocks made to rest upon it. On a dyke, or road with a ditch on each side, the carriages must be run as close to the edge as possible, and the trails and stocks held up while the limbers pass. Great care must be taken not to run the carriages too far, and the wheels must be scotched or locked at the edge of the dyke or ditch.

REMARKS.—When a battery is in stationary quarters, there must be a weekly inspection of every part of it, and, when circumstances permit, a parade in marching order; at which parade every part of the harness, carriages, and appointments of the cannoneers is expected to be in the best order. Particular attention should be given to the state of the ammunition, which must be frequently aired.

The battery should frequently take out a day's forage, secured and arranged as for service; the detachments being in marching order, and their blankets, etc. properly fixed.

It should be made to go over all sorts of ground, up and down steep slopes and across ditches. The intrenching tools should be occasionally taken off, and used in filling up holes and making ramps, to enable the carriages to pass over difficult ground.

INSTRUCTION FOR THE PRESERVATION OF HARNESS.

The preservation of harness requires two kinds of attention: one, that of neatness, which must be continual; the other, strictly that of preservation, which consists in oiling the leather parts two or three times a year.

To keep the harness neat, the men should wipe and carefully clean it whenever it has been used.

Collars, which it is important to keep soft and supple, must be carefully attended to.

Airing and beating with a rope or small mallet, the stuffing of the collars and saddles, are important duties, which must not be omitted on continued marches.

In giving the second kind of attention to harness, that of preservation, the oiling should be done oftener in summer than in winter.

The best oil for this use is neat's-foot oil, the unctuous property of which is particularly suitable for preserving the suppleness of the leather. This oil contains no siccative part, and may be used unpurified. As a maximum, four pints and a half will answer, each time, for oiling the harness of a team of six horses.

Before using the oil, every part of the leather must be perfectly cleaned and washed, without, however, allowing the water to penetrate deeply into the leather. While still damp, blacken those places which have become red, with hatter's dye, ink-ball, or acetate of iron; and when the leather begins to dry, oil it, spreading the oil on with a sponge, or thick and soft brush. When neat's-foot oil cannot be obtained, fish oil, if pure, may be used. This is very good for preserving black leathers; but it must be carefully ascertained not to contain any siccative matter, as that would render it injurious.

Other oils may be usefully employed, as whale oil, when they

can be obtained pure; this is not easily done, and it is difficult to detect the fraud.

Vegetable oils are very injurious.

On campaigns, good oils can rarely be procured; under these circumstances a mixture of three-quarters of melted lard and one-quarter of whale oil may be used: it should be spread over the leather with a piece of woollen cloth, and rubbed in well.

TRANSPORT OF BATTERIES BY SEA.

Transports for horses should be prepared specially for the purpose. The stalls should be, preferably, between decks; never, if it can be avoided, in the hold; and there should be a sufficient number of ports for light and ventilation.

Stalls should be about $6\frac{1}{2}$ feet long, 28 inches wide; *tail boards*, fastened to the rear posts, and padded as low as the hough; *breast boards* and *side boards* fitted in grooves about 4 feet from the floor, the first padded on the inner side and upper edge; the latter on both sides: the *floors* of the stalls set on blocks, that the water may pass under them; *four slats* across each floor to give the horses foot hold. *Troughs* should be made to hang with hooks so as easily to be disengaged.

Before the embarkation, the side boards are removed, and replaced as each horse is put in his stall.

Should horses be stalled on the spar deck, on no account should anything be stowed upon the sheds.

TO EMBARK THE HORSES.

If the embarkation can be made from a wharf, the horses are slung; or, if the height of the vessel's side will permit, they are led by ramps to the deck, and then lowered. If the transport cannot lay at a wharf, the horses are brought alongside in lighters and transferred by slings; the ascent and descent of the horse are regulated by two guys, attached to the halter; one to be held on the lighter; the other on the transport. In a sea way the horses must be run up rapidly to avoid injury.

The sling is made of stout canvas, two feet in width and about

four in length, doubled on the edges one inch, and hemmed down. The ends are separated by pieces of wood of sufficient strength, to the extremities of which the ropes are attached.

Breast straps and breeching of rope complete the sling.

TO EMBARK THE BATTERY.

The pieces and caissons are brought to the wharf or shore and unlimbered; the ammunition chests, and wheels taken off; each set of implements is strapped together, the washers and lynch pins are put in a box; the harness is tied and labelled in sets.

The forge and battery wagon are unlimbered, and the front boxes taken off, as well as the spare parts outside of the wagon.

All of the chests are to be distinctly marked, so that it can immediately be seen where they belong. Too much care cannot be observed to separate and distinguish the ammunition of the howitzers.

The place for dismounting the guns depends upon the manner of embarking, as they can readily be lifted from their carriages.

In the transport, the guns are the first to be lowered to their places between decks; then the carriages, limbers, implements, and wheels; the harness is placed (regard being had to its preservation) where it may be of easy access.

The box of washers and lynch pins is in the especial charge of a non-commissioned officer.

The battery wagon and forge, with their limbers and limber-chests, are stowed away from the battery, but where they will be accessible.

TO DISEMBARK.

When the transport is at a wharf no especial directions are necessary. Generally, the debarkation is in the inverse order of the embarkation.

At a distance from the shore, lighters are employed upon whose decks the horses are lowered; when these have approached as near the shore as possible, the horses are backed over their sides.

The battery may be landed in surf-boats or flats, according to the nature of the shore.

In the face of the enemy the guns should be mounted, and when the boat has beached, it can be dismantled overboard, and hauled up by drag ropes, and the carriages brought ashore by hand.

IN ACTION, OR PREPARING FOR ACTION.

In those formations in battery in which the pieces or sections are brought up successively on the right for **action front**, each piece should reserve its fire until the one on its right is unlimbered, and its limber reversed: by not attending to this, the horses become so frightened as not to be brought up to the piece without difficulty.

No positive rule can be laid down with respect to the caissons in presence of an enemy. This must depend upon a variety of circumstances; but, in general, it will be found expedient to place them under charge of an officer, who will conform to the movements of the main body, in such a manner, and at such distance, as to enable him to supply the pieces with ammunition before that which is in the limbers is expended.

In a hilly road, when any obstruction is expected from the enemy, the leading gun should always be twenty-five or thirty yards in advance of the others, in order to leave room for the limber to take its place in rear when it comes into action, without the necessity of running back the rest of the column. This might be avoided in some cases, by running the piece forward, but cases may arise where it would not be advisable to do so.

When pieces are in position on the brow of a hill, they should be retired from it as far as they can be without losing the command, in order that the men may be covered as much as possible. If it is necessary to place them close to the edge, it should not be done until the firing is about to commence.

Should a battery be ordered to come into action to a flank upon a dyke, or road which is entirely open, with a ditch on each side of it, the carriages must take double distance from each other, and the caissons turn so as to bring their rear towards the enemy. When the piece is unlimbered, the limber moves near the caisson and turns its rear also towards the enemy. If the road is too

narrow to allow the caissons to change their direction, they remain in the same line with the pieces, and in the middle of the interval between two of them; the limbers do not reverse, but move forward to the caisson of the preceding piece.

When pieces are placed on the edge of a considerable slope, they may be run down by hand, the limbers backing so far as to allow the pieces, when the prolonges are stretched, to fire with effect, and command the whole slope. The pieces should, however, be only run down sufficiently to effect this purpose, that the limbers may be as far as possible from the edge, and, consequently, in some degree covered. Should there be anything at hand, the wheels may be scotched; or, if there is time, a small cut may be made across the hill. By these precautions pieces may be fired down a slope so considerable, that they would otherwise run down themselves.

Should there be any fear of a piece running forward, when unlimbered for action on the brow of a hill, the wheel should be locked with the lock chain, prolonge, or drag rope. It must be applied to the top felloe, or spoke of the wheel, instead of the lower one.

In passing a defile or bridge with the enemy on the other side, and likely to oppose the advance, the pieces alone should move forward, leaving the caissons to follow in rear by themselves.

In retiring through a defile or over a bridge in the presence of an enemy, the caissons should be sent to the rear; one or two may be kept nearer than the others for supplying ammunition.

The prolonge should be generally used when artillery is retiring slowly. When the rear of the column retires with the prolonge along a road, cavalry will hesitate to attack it, if its flank be secure.

After firing, either on drill or in action, the bore of the piece should be washed and the piece depressed.

REPLACING KILLED OR DISABLED HORSES.

The teams of the pieces must always be kept complete at the expense of those of the caissons. A disabled horse, in the first instance, is replaced by the corresponding one at the caisson, leaving the caisson to refit with a spare horse and the harness of the disabled one. After all the spare horses have been used, those of the caissons should be taken in succession, so that they may be gradually and regularly reduced.

ORDER OF ENCAMPMENT FOR A BATTERY OF ARTILLERY.

PLATES 3 and 4 represent the ordinary modes of encampment. Other modes or combinations of these two are adopted when the circumstances require.

FIRST MODE.

In this mode the pieces are parked with diminished intervals; and the tents and horses are placed upon the flanks in lines parallel to each other and perpendicular to the front, so as to give the encampment a front of the same extent as the battery in line. The horses of each half battery are picketed together upon their appropriate flank. The team of the flank piece is placed at the end of the picket rope in front, and that of its caisson next. Then come the teams of the next piece and caisson, and so on in the same order. The horses of the chiefs of pieces are with their appropriate teams. The teams of the other carriages are afterwards picketed in the same order with reference to their positions in park; and finally the horses of the officers near the end of the rope.

When two or more batteries are encamped together, the interval between the camps is equal to that between two batteries in line; and the captain's tent is between those of his lieutenants.

In horse artillery, the front of the encampment would be 97 yards, and the interval between the pieces 7. The horses of each detachment would be picketed after the teams of its caisson.

SECOND MODE.

In this mode the pieces are parked with full intervals, and the horses and tents are placed in parallel lines in rear. When a single line of picket rope is not sufficient for the horses, a second is placed 4 yards in rear of the first, and the horses made to face each other. The teams of the pieces and caissons are placed in the order of their pieces along the centre of the first line, and those of the other carriages are placed upon their flanks opposite the half batteries to which they belong. If necessary a part of them are placed in rear of the second line. The horses of the officers are at the extremities of the line.

In horse artillery, in which the second line is always necessary, the horses of the detachments are picketed together in their proper order along the centre of that line; and the officers' horses at the extremities of the same.

In this mode of encampment the intervals between two adjoining batteries and the position of the captain's tent are subject to the same rules as in the other.

Instead of placing the harness in lines as represented in the plates of the preceding modes of encampment, it may be placed upon the carriages and covered by tarpaulings when it is possible to do so. The saddles and bridles of the riding horses may also be covered by placing them in the tents with the men.

The number of lines upon which a battery is parked varies according to the number of spare carriages attached. The battery of manoeuvre, which is composed of the pieces and their appropriate caissons occupying the two front lines.

1st Plan of Encampment, for a Mounted Battery.

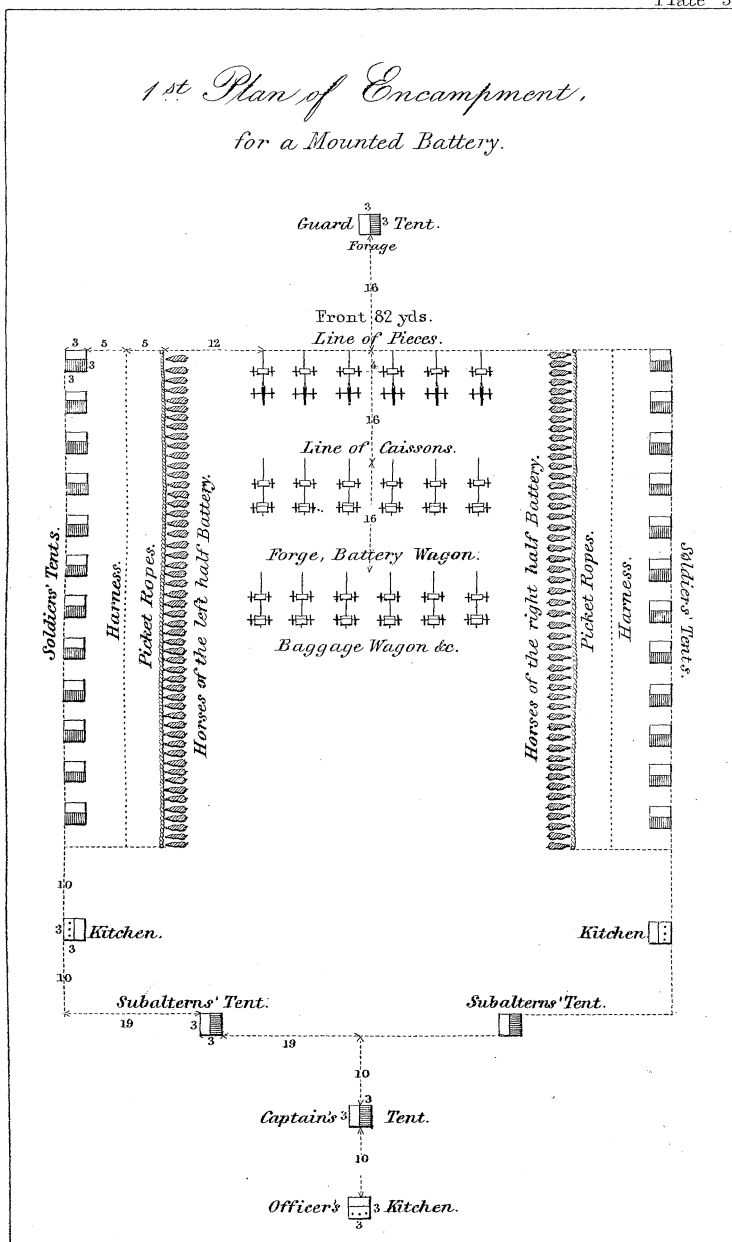

*2nd Plan of Encampment,
for a Mounted Battery.*

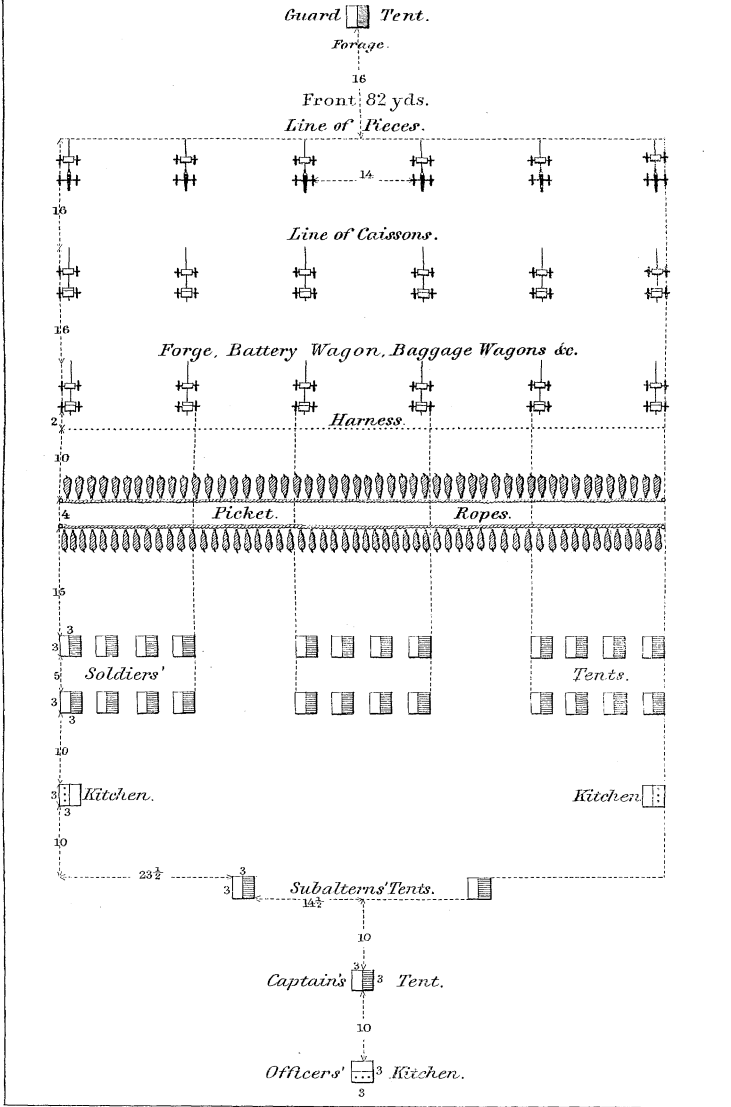

PART II.

INSTRUCTION FOR FIELD ARTILLERY.

TACTICS.

BASIS OF INSTRUCTION.

THE COMPANY.

THE text applies especially to companies serving mounted batteries. Such variations as are required to adapt it to *horse artillery* are noted, and the portions applicable to that branch alone are so indicated.

In the artillery, as no two men of a piece, cannoneers or drivers, perform the same duties, each should be specially assigned to that position for which he is best fitted.

The men, whether cannoneers or drivers, are permanently attached to pieces, and will not be transferred except by order of the captain, or temporarily to equalize detachments on drill or parade.

The cannoneers assigned to the service of a gun constitute a *gun detachment*, and are commanded by the gunner. When the company is paraded, dismounted, these detachments fall in each on the right of the men of its own piece—the cannoneers taking their places according to their numbers in the detachment.

When the cannoneers and drivers attached to a piece are assembled in rank and file formation, they constitute a *platoon*, which is commanded by the sergeant who is chief of the piece. The drivers form on the left, and the platoon is divided into detachments of the same size as the gun detachment, the men being numbered in the same manner.

Two platoons constitute a *section*, which is commanded by a lieutenant.

The *company* is composed of two, three, or four sections. The instruction laid down is applicable to either case, but is given for three sections. When there are four sections, the company is further divided into *divisions*, each composed of two sections, and commanded by its ranking chief of section. The company will not be manœuvred by *divisions* unless circumstances require it, the section or platoon being the most convenient subdivision for manœuvring.

The company is commanded by a captain. A subaltern, in addition to the chiefs of sections, is attached to it. He performs the staff duties of the battery, and commands the line of caissons in the battery formations. In addition to the platoons, there should be attached to the company one **sergeant-major** or **first sergeant**; one **quartermaster-sergeant**; two **buglers** or **trumpeters**; one **guidon**; and such number of **artificers** as the service of the battery may require. In the absence of the lieutenant chief of the line of caissons, he is replaced by the first sergeant.

FORMATION OF THE COMPANY.

(PLATE 5.) The platoons form when in line in the order of their pieces in park, and touching each other. The two forming a section are designated as the right and left platoons, according to their actual positions with reference to each other in the sections.

When necessary, surplus men may be transferred from one platoon to another, so that there shall be but one incomplete detachment in the company, which should not be on the flank. When an incomplete detachment consists of an odd number of men, the vacancy is left in the rear rank, in the next file but one from the left, that number being omitted in calling off.

To prevent the formation of incomplete detachments, artificers may be assigned as Nos. 8; or the permanent chiefs of caissons may be assigned as gunners to detachments, other than the gun detachment, and posted 1 yard behind their right files.

Column of Platoons.

Order in line, dismounted.

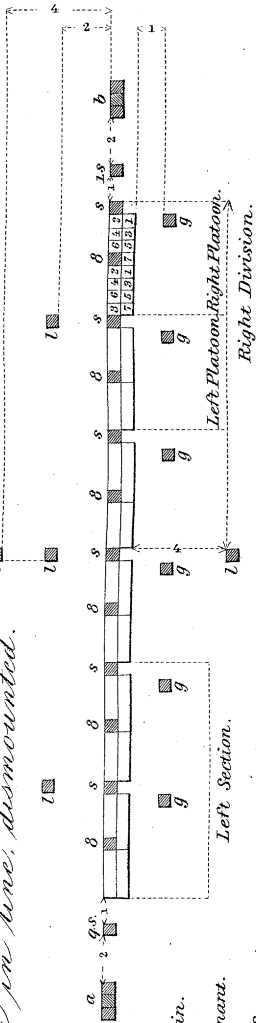

c. Captain.

l. Lieutenant.

1s. First Sergeant.

q.s. Quartermaster Sergeant.

s. Sergeant.

g. Gunner.

8. N° 8. Gun detachment.

a. Artillery.

b. Bugler s.

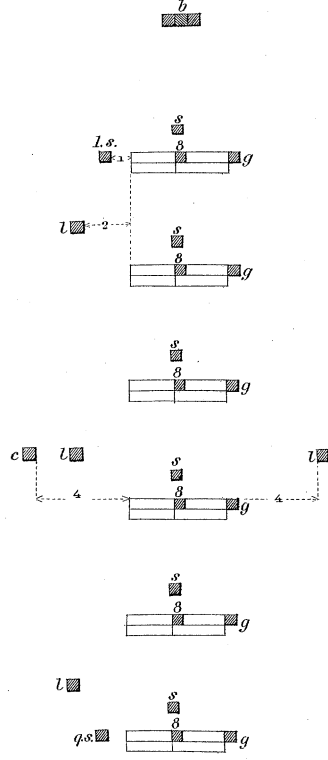

When the company is formed for parade purposes, and it is not desired to manœuvre by detachments, the platoons may be equalized and regarded as the units. They are then formed as single detachments, the chiefs of caissons being posted as the front rank men of the left files of the platoons. The men call off from No. 1 to No. 8, as if divided into **detachments** of eight men each.

The sections are designated according to their actual positions in line, as the **right**, the **centre**, and the **left** sections. If there are four, they are designated according to actual position, as the **right**, the **right-centre**, the **left-centre**, and the **left** sections.

When the company consists of four sections, the right and right-centre sections constitute the right division; the left and left-centre sections, the left division.

None of the designations of the platoons in a section, nor of sections and divisions in the company, are permanent. They shift from one to the other, according to the actual positions of the subdivisions with reference to each other.

POSTS OF THE OFFICERS, NON-COMMISSIONED OFFICERS, Etc.

(PLATE 5.) The captain commanding goes wherever his presence may be necessary, or his commands best heard. His position is, in the **order in line**, 4 yards in front of the centre of the company; in the **order in column**, or when **faced by a flank**, 4 yards outside the marching flank, opposite the centre of the company.

The lieutenants commanding sections, **in line**, or **in column of sections**, are 2 yards in front of the centres of their respective sections; **in columns of platoons or of detachments**, or when **faced by a flank**, they are 2 yards outside the marching flank, and opposite the centres of their respective sections; except that when **faced by a flank**, the chief of the leading section takes his place at the side of the leading file.

In column of divisions, the ranking chief of section in each division is 4 yards in front of the centre of his division; the other chief of section keeps his position of 2 yards in front of the centre of his section.

The lieutenant, chief of caissons, is, **in line**, 4 yards behind the centre of the company; **in column**, or **faced by flank**, he is 4 yards outside of the pivot flank, and opposite the centre of the company.

The sergeants, chiefs of pieces, when **in line**, **in column of sections**, or **faced by a flank**, are on the right of the gun detachments of their respective platoons, in the front rank. **In column of platoons**, or **of detachments**, they are 1 yard in front of the centre of their platoons or of their gun detachments.

The corporals, gunners, when **in line**, or **column of sections**, are 1 yard behind the right files of their respective gun detachments. **In columns of platoons**, or **detachments**, they are on the right of the gun detachments. When the column has a detachment, other than the gun detachment, at its head, the gunner of the platoon to which it belongs will place himself 1 yard in front of its centre, unless the chief of caisson of that piece is acting as its file-closer; in which case the latter leads the column. When **faced by a flank**, they face with the company, and keep their relative positions.

The corporals, chiefs of caissons, are in their places in the ranks as Nos. 8 of the gun detachments, or as the front rank men on the left of their platoons, or they may be assigned as gunners to detachments, other than the gun detachments, in the case already provided for to prevent the formation of incomplete detachments.

The first sergeant, **in line**, is on the right of the company, in a line with the front rank, and 1 yard from it; **in column**, he is on the marching flank, 1 yard outside the section, or other subdivision, nearest to him when in line. When **faced by flank**, he faces with the company.

The quartermaster-sergeant occupies positions on the left of the company, corresponding to those of the first sergeant on the right, whether **in line**, **in column**, or **faced by a flank**.

The buglers or trumpeters, **in line**, are on the right of the first sergeant, in one rank, and 2 yards from him; **in column**, they are 6 yards in front or rear of the subdivision next them in line,

according as that subdivision forms the head or rear of the column. When the company faces **by flank**, they face with it.

The artificers occupy positions on the left of the company corresponding to those of the musicians on the right, whether **in line, in column, or faced by a flank**.

The guidon forms with the musicians, and on their left, or takes such position as the captain may prescribe.

When in the movements or manœuvres, the subdivisions originally on the right and left become those of the left and right, the non-commissioned staff, musicians, and artificers remain with the subdivisions near which they were originally formed, and take corresponding positions in line, etc. If, for instance, the line should be formed faced in the opposite direction, by a **reverse** of the sections, to the right or left, they would **reverse** at the same time, and the line would then be formed as follows—from right to left: the artificers; quartermaster-sergeant; company; first sergeant; guidon, and musicians. The proper distances being taken from the company.

THE BATTERY.

The manœuvres of infantry, cavalry, and artillery are regulated by the same general principles; but as the infantry constitutes the main body of an army, its movements necessarily control those of the other arms. In this work the infantry forms of command have been adopted for the artillery as far as the difference between the two services would permit.

A battery executes nearly the same manœuvres as a battalion of infantry, but with less precision. For its elements cannot be moved with the same accuracy as platoons of well-instructed infantry. In some respects the exercises prescribed for field batteries exceed those required for the purposes of war. But they should be regarded as a study which it is advantageous to extend beyond its ordinary applications; so that the most difficult circumstances may not present anything that is unknown, or that may lead to the commission of serious errors.

No rules are laid down for the application of field battery

manœuvres to the evolutions of troops of different arms. Although all arms are governed by the same general principles, each has an appropriate code for its own manœuvres, which is not extended to the general movements of other troops. The best, and perhaps the only way, for an artillery officer to manage his battery properly, when manœuvring with other troops, is to understand the infantry and cavalry manœuvres; so that he may at once comprehend the command of the general officer and determine the position which the artillery should take. No rules can be laid down for conducting batteries to the positions they are to occupy; for the order, gait, and direction of each battery are modified by the configuration of the ground to be passed over, as well as by the march of the infantry and cavalry. The artillery, without being obliged to follow step by step all the manœuvres of the infantry and cavalry, proceeds to the execution of its orders in the easiest and most expeditious manner. The proper employment of this arm, according to the situation of the ground and the circumstances of the case, must ever be kept in view in all orders issued to it.

GENERAL PRINCIPLES.

The battery of manœuvre is divided into sections, each being composed of two pieces and two caissons. The column of sections is not only found to be sufficient for the purposes of manœuvre, but much more convenient than the column of pieces or half batteries. The column of pieces requires too great an extension of the battery and too much time for its evolutions. In the column of half batteries one chief of section is deprived of his command; and, when formed at full distance, the depth of the column is essentially the same as in that of sections. Moreover, when this column is used for manœuvre, the pieces of the same section cannot be kept long together in any part of the battery. These objections to the column of half batteries do not, however, apply to the eight-gun battery, which can be manœuvred by half batteries without depriving a chief of section of his command, or separating the pieces of the same section. Habitually this battery

will be manœuvred by sections, but when necessary, or expedient, it may be manœuvred by half batteries.

Each piece and its caisson are kept in a fixed relation to each other, and may be said to constitute a unit. They are separated only in the formations in battery. This principle simplifies the manœuvres greatly, and renders it generally unnecessary to give separate commands to the caissons.

No notice is taken of inversions in any of the orders, either in column, in line, or in battery. The most simple and rapid formations are always adopted.

The passage of carriages is used as an elementary principle in the manœuvres. In the formations in battery it is indispensable for changing the front of a line; and when executed seasonably, as a preparatory movement, it greatly facilitates all the formations. It may be executed with the same, or an increased gait.

But one wheel is admitted. The pivot carriage preserves its gait, while the others regulate theirs according to their distances from it; the guide being always on the pivot flank.

No general or special guides are used. The chiefs of pieces, and in horse artillery the chiefs of caissons also, are the guides of the carriages to which they are attached. And each becomes the guide of the line or column whenever his carriage occupies the position to which the movements are referred.

The cautionary command **Attention** is not embraced among those required for the manœuvres, but may be used at the discretion of the captain. The commands of the chiefs of sections are more numerous, and those of the captain are more frequently repeated than in other arms of service, on account of the noise of carriages and extent of command.

As a general rule, the cannoneers should mount the ammunition chests only for rapid movements; and when within range of the enemy's guns they should dismount, unless important considerations require a continuation of the rapid gait. The explosion of a caisson when the cannoneers are mounted might destroy many men.

The three orders, in column, in line, and in battery, are so

established as to occupy the least possible space, and to require the least ground for their formations. In both kinds of artillery, whether in column or in line, the distance between two carriages, or between a carriage and detachment, is 2 yards. The interval is so calculated that the column may be readily formed into line. The intervals thus resulting are different in the two kinds of artillery; but when they manœuvre together, the carriages of foot artillery take the intervals and distances belonging to those of horse artillery.

In the order in battery the distances are the same for both kinds of artillery. This order presents an arrangement which the exigencies of war habitually vary. But the rule requiring the limbers and caissons to face towards the enemy, should be departed from only while firing in retreat.

In that formation in battery which requires the caisson and detachment of horse cannoneers to pass the piece, the detachment does not pass until after the caisson; and the cannoneers do not dismount until the detachment has reached its place in battery. The first part of this arrangement arises from the fact, that the passage of the caissons is a preparatory step, which should be completed before the command **In battery** is given. The second part is intended to avoid the difficulty which would be experienced by the horse holders in leading their horses, and the inconvenience and danger of halting near the piece, and thus grouping all the horses together at the moment of coming into battery.

Two methods have been adopted for the formations in battery to the front: one requiring the pieces to be thrown forward, the other requiring the caissons to be thrown to the rear. The first method is equally adapted to light and heavy batteries. By this method the pieces and caissons are rapidly separated; and the commands may be given while the battery is moving, so as to leave the caissons at their proper distance in rear of the line on which the pieces are to form. The second method is not adapted to heavy batteries, on account of the difficulty of turning the pieces about by hand. But with light pieces it is advantageous

when the battery is already formed upon the line of battle, or when the head of a column which is to be formed into battery is very near that line. In horse artillery the first method of coming into action is considered the best; for, while the cannoneers are dismounting, the pieces are moved forward and wheeled about by the horses, so that nothing remains for the cannoneers but to unlimber and commence firing. Moreover, when the command for this formation is given, the detachments halt at once on the ground which their horses are to occupy in battery.

COMPOSITION OF THE BATTERY OF MANŒUVRE.

(PLATES 28, 29.) The **Battery of Manœuvre** is composed of six field pieces and six caissons, properly manned, horsed, and equipped. It is sometimes reduced to four or increased to eight pieces. The tactics is adapted to either number, but six pieces are supposed.

Each carriage is drawn by four or six horses, and the officers and men are as follows:—

One captain, who commands the battery.

Three lieutenants, each commanding a section; the section of the junior lieutenant should be in the centre.

One lieutenant commanding the line of caissons.

When half batteries are formed, they are commanded by the two lieutenants highest in rank.

Six mounted sergeants, each charged with guiding and superintending a piece.

Twenty-four, or thirty-six drivers, being one to each pair of horses.

Six detachments of cannoneers, each containing nine men in mounted batteries, and eleven in horse batteries. This number includes two corporals, one of whom is chief of the caisson; and the other the gunner, has charge of the gun and its detachment. In each detachment of *horse artillery* two of the cannoneers are horse holders.

Two trumpeters or buglers.

One guidon.

The battery is divided into three sections, denominated the **right**, **left**, and **centre** sections. Should there be four sections, they are denominated the **right**, **right-centre**, **left-centre**, and **left** sections. A section contains two pieces and two caissons, and in each section the pieces are denominated **right piece** and **left piece**.

The battery is also divided into half batteries, denominated **right half battery**, and **left half battery**.

The word **piece** applies to the gun or howitzer, either with or without its limber; and sometimes to the piece and caisson together.

The **front of a battery**, in the order in battery, is the front of the line of pieces. In all other formations it is the front of the first line of drivers.

The **right or left of a battery** is always that of the actual front, whether the pieces or caissons lead.

The **interval** is a space measured parallel to the front.

The **distance** is a space measured in depth, or perpendicular to the front.

The **measures of intervals and distances** are given in yards, and express the vacant spaces between the component parts of the battery.

(PLATE 25.) The object of a **right or left wheel** is to give the carriage a direction perpendicular to the one it had before. In executing it, the leading horse on the pivot flank describes a quadrant (5 yards) of a circle whose radius is 3·25 yards, and then resumes the direct march. The horse coupled to him increases his gait and conforms to his movement, resuming the direct march at the same time. The centre and wheel horses follow in the tracks of their leaders.

(PLATE 25.) The object of a **right or left oblique** is to give the carriage a direction inclined 45° to the right or left of the one it had before. In executing it the leading horse on the pivot flank describes the eighth of a circle whose radius is 3·25 yards, and then resumes the direct march. The horse coupled to him increases his gait, conforms to his movement, and resumes the

direct march at the same time. The other horses follow in the tracks of their leaders. The oblique of a carriage is in fact one-half of a right or left wheel.

(PLATE 25.) The **passage** applies to two carriages in file, and its object is to pass the rear carriage to the front. To execute it the rear carriage inclines to the right, passes the one in front, and takes its proper distance in front by inclining to the left. The reciprocal gaits of the carriages are regulated by commands.

(PLATE 26.) The object of an **about** is to establish the carriage on the same ground, but in the opposite direction, having the heads of the leading horses where the hinder part of the carriage was before. For the easy execution of this movement at all gaits, and with a carriage of four wheels, all the horses incline at once to the right as they advance, and so move, according to their distances from the pole, as not to interfere with the wheel horses which really govern the carriage. (See No. 420.)

In **horse artillery** the detachment of cannoneers follows the piece, which advances 7 yards after finishing the about, in order that the heads of the leading horses may reach the position occupied by the rear of the detachment.

(PLATE 26.) The **countermarch** applies to two carriages of different kinds in file. Its object is to make them both perform the about and to establish them on the ground they occupied before, but in the opposite direction and with the same carriage in front. In performing it the carriage of the front rank executes an about at once, and moves to the place which was occupied by the other carriage. The latter follows the track of the former, executes the about on the same ground, and takes its place.

(PLATE 25.) There is but one kind of wheel, which is that with a moving pivot. The carriage on the pivot flank wheels in such a manner as to unmask the ground where the movement commenced. When the wheel is made with a section front, the pivot carriage describes a quadrant (5 yards) of a circle whose radius is 3.25. With a battery front the pivot carriage describes a quadrant (22 yards) of a circle whose radius is 14. (PLATE 49.) If the wheel be ordered from a halt, the pivot carriage moves at

a walk; if on the march, it preserves its gait. In all cases the marching wing regulates its gait in such a manner as to remain the shortest possible time in rear of the line, without urging the horses unnecessarily. In all wheels the guide is on the pivot flank, and the intervals are preserved from that flank.

In **mounted batteries** the chiefs of pieces act as guides, marching for that purpose with the leading carriages.

In **horse artillery** they are also guides, except when the caissons lead and their chiefs are mounted; these chiefs becoming the guides in that case. The guide of the battery is that of the carriage to which the movements are referred.

The **alignment** is made on the drivers of the wheel horses, except in battery, when it is made on the hind wheels.

In giving commands the strength of voice should be proportioned to the length of the line. When a chief of section does not hear the commands, he regulates his movement by what he sees executed by an adjoining chief. The command **Attention** is given by the captain at the commencement and at each renewal of the exercise; but afterwards it is given only when he thinks it necessary to fix attention.

Trumpet or bugle signals are used instead of commands when ever they can be advantageously introduced. The signals and calls in use will be found in their appropriate place at the end of the work. (PLATES 81 to 88 inclusive.)

PART III.

SCHOOL OF THE PIECE.

ARTICLE FIRST.

METHOD OF INSTRUCTION.

1. THE object of this school is the regular and progressive instruction of the artilleryman in his duties at and connected with the piece, from the period of his joining as a recruit.

This instruction is given by the non-commissioned officers, under the supervision of the chiefs of sections.

The instructor should never require a movement to be performed until it is exactly explained and executed by himself. It should be left to the recruit to take the positions, and execute the movements directed, and he should be touched only to rectify mistakes arising from want of intelligence.

Each movement should be perfectly understood before passing to another. After they have been properly executed in the order laid down, the instructor no longer confines himself to that order.

The instructor allows the men to rest at intervals during drill, and for this purpose he commands **Rest**. At this command the recruit is no longer required to preserve immobility. At the command **Attention**, the man takes his position, and remains motionless.

Great patience and the utmost precision are necessary on the part of the instructor. He should especially endeavor to excite a spirited and active deportment at every military exercise; and above all not to disgust the men by too long an application to any one point in the drill.

THE CANNONEER DISMOUNTED.

Elementary Instruction.

2. This part is taught to each recruit individually, or at most to four at a time. In the latter case, they are placed on the same line, 1 yard from each other, without being required to align themselves.

POSITION OF THE CANNONEER DISMOUNTED.

3. The heels on the same line, and as near each other as the conformation of the man will permit; the feet turned out equally, and forming with each other something less than a right angle; the knees straight; body erect on the hips, inclining a little forward; shoulders square; arms hanging naturally, with the palms of the hands turned a little to the front; head erect; chin slightly drawn in, eyes to the front; the position of the whole body without constraint: when the sabre is worn, the left hand hangs by the side and over it.

EYES RIGHT—EYES LEFT.

4. The instructor commands:

1. *Eyes*—RIGHT. 2. FRONT.

At the command RIGHT, turn the head gently to the right, so that the inner corner of the left eye may be on a line with the buttons of the jacket, the chin well drawn in. At the command FRONT, turn the head gently to the front.

The command *Eyes*—LEFT, is executed on the same principles.

FACINGS.

5. **To the right or left.** The instructor commands:

1. *Cannoneers right*, (or *left*.) 2. FACE.

At the command FACE, raise the right foot slightly, turn on the left heel, and replace the right foot by the side of the left.

6. **To the rear.** The instructor commands:

1. *Cannoneers rear*. 2. FACE.

At the command *rear*, make a half face to the right, turning on the left heel, place the right foot square behind the left, the hollow of it opposite to and 3 inches from the left heel. At the command **FACE**, turn on both heels to face to the rear, and bring the right foot by the side of the left.

7. **Half-face.** The commands are :

1. *Cannoneers right (or left) oblique.* 2. **FACE.**

At the command **FACE**, raise the right foot a little, turn upon the left heel, making a half face, and replace the right foot by the side of the left.

The instructor will take care that in executing the facings the position of the body is not deranged.

MARCHING.

8. The length of the marching step is 28 inches ; its quickness at the rate of 110 steps a minute. For the elementary instruction of recruits, the quickness of the step is reduced to 90 a minute. When the command *Double-quick* is given, it is increased to 165. To explain the principles and mechanism of the step, the instructor, placing himself 8 or 10 yards in front of and facing the men, describes and slowly executes it himself. He then commands :

1. *Cannoneers—forward.* 2. **MARCH.**

At the command *forward*, throw the weight of the body on the right leg. At the command **MARCH**, carry the left foot briskly forward 28 inches, the toe a little depressed, and, as well as the knees, turned slightly out ; the upper part of the body inclining slightly forward ; plant the left foot without a shock on the ground, throwing the whole weight of the body upon it ; carry forward the right leg smartly and evenly, the foot near the ground ; plant it at the same distance, and in the manner described for the left foot, and continue the march, keeping the face and shoulders square to the front.

The instructor marks the cadence of the step, from time to time, by the commands *right*, or *left*, or both ; given at the moment that the foot indicated should be planted.

TO HALT.

9. The instructor commands :

1. *Cannoneers.* 2. HALT.

At the command HALT, which should be given as one foot comes to the ground, bring the one in rear to the side of it without shock.

TO MARCH BACKWARDS.

10. The instructor commands :

1. *Cannoneers backwards.* 2. MARCH.

At the command MARCH, carry the left foot 14 inches to the rear, then bring the right foot likewise to the rear of it, and so on, successively, until the command :

1. *Cannoneers.* 2. HALT.

At the command HALT, bring the foot which is in front by the side of the other.

The instructor requires only a few steps to be taken. He observes that the men step straight to the rear; that they do not hollow the small of the back by throwing back the shoulders; and that they always preserve the equilibrium, and the position of the body.

TO MARK TIME WHEN MARCHING.

11. The instructor commands :

1. *Mark time.* 2. MARCH.

At the command MARCH, bring the heels by the side of each other, and mark the cadence of the step by raising the feet alternately, without advancing them, until the commands are given :

1. *Forward.* 2. MARCH.

At the command MARCH, given as one foot is coming to the ground, the cannoneers resume the step of 28 inches with the other.

TO CHANGE STEP.

12. The instructor commands :

1. *Change step.* 2. MARCH.

At the command MARCH, given at the moment one foot is coming to the ground, bring the other to its side, and step off again with the first. The men are thus taught to take the step when they have lost it.

TO FACE WHEN MARCHING.

13. **To the right.** The instructor commands:

1. *Cannoneers by the right flank.* 2. MARCH.

At the command MARCH, given at the moment the left foot is coming to the ground, turn the body to the right, and step off with the right foot in the new direction, without losing the cadence of the step.

14. **To the left.** The instructor commands:

1. *Cannoneers by the left flank.* 2. MARCH.

At the command MARCH, which is given as the right foot is coming to the ground, turn the body to the left, and step off with the left foot.

15. **To the rear.** The instructor commands:

1. *Cannoneers to the rear.* 2. MARCH.

Which is executed as directed for facing to the right, excepting that the body is turned to face to the rear instead of to the right.

16. **Half-face to the right or left.** The instructor commands:

1. *Cannoneers right (or left) oblique.* 2. MARCH.

At the command MARCH, make a half face to the right, (or left,) and step off in the new direction, with the leg on the side towards which the turn is made.

17. **To resume the primitive direction.** The instructor commands:

FORWARD.

At this command, make a half face so as to move in the original direction, and march straight to the front in the manner prescribed for the oblique.

MANUAL OF THE SABRE.

18. To show the mechanism, the execution of each command is divided into *motions*, with *pauses* between them. The last word of a command should be followed by the prompt execution of the first motion, and the words TWO, THREE, etc., by that of the other motions. When the words of execution are to be so given, the instructor intimates that the manual is to be *by detail*: this rule is general.

After the different motions are perfectly understood, they are executed without stopping at each one; care being taken that none of them are slighted, and that the manual does not derange the position of the body.

19. From four to eight men are placed in one rank, 1 yard apart. They will be exercised for a portion of the time in the facings and marchings, wearing their sabres sheathed and hooked up.

20. The instructor points out and names the different parts of the sabre—HILT: *gripe, guard, sword-knot*; BLADE: *back, edge, point*; SCABBARD: *rings, springs*. He then commands:

1. DRAW. 2. SABRE.

At the command DRAW, turn the head slightly to the left without deranging the position of the body; unhook the sabre with the left hand, and bring the hilt to the front; run the right wrist through the sword-knot, seize the gripe, draw the blade 6 inches out of the scabbard, pressing the scabbard against the thigh with the left hand, which seizes it at the upper ring; and turn the head to the front.

At the command SABRE, draw the sabre quickly, raising the arm to its full extent, and throwing forward the point; make a slight pause, carry the blade to the right shoulder, edge to the front; the wrist resting against the hip; the little finger on the outside of the gripe.

This position is the same when mounted, except that the wrist then naturally falls upon the thigh.

Present—SABRE.

21. At the command SABRE, carry the sabre to the front, the arm half extended, the thumb opposite to and 6 inches from the neck; the blade perpendicular, the edge to the left; the thumb extended on the side of the gripe; the little finger by the side of the others.

Carry—SABRE.

22. At the command SABRE, carry the back of the blade against the hollow of the shoulder; the wrist resting against the hip, the little finger on the outside of the gripe.

Inspection of—SABRE.

2 pauses; 3 motions.

23. At the command SABRE, take the position of *present* SABRE.

TWO. Turn the wrist inwards; show the other side of the blade; and turn the wrist back.

THREE. Carry the sabre to the shoulder.

On parade, the last motion is not executed until the inspector has passed the next man.

1. RETURN. 2. SABRE.

24. At the command RETURN, bring the sabre to a present.

At the command SABRE, carry the wrist opposite to and 6 inches from the left shoulder; lower the blade, and pass it across and along the left arm, the point to the rear; turn the head slightly to the left, fixing the eyes on the opening of the scabbard; return the blade; free the wrist from the sword-knot; turn the head to the front; drop the right hand by the side; and hook up the sabre. This is done by seizing the upper ring between the thumb and fore finger of the left hand, back of the hand up, raising the scabbard, whilst turning the hilt towards the body, until it points to the rear; and passing the ring over the hook attached to the waist-belt.

25. When the cannoneer is dismounted, the sabre, when

H

worn, is hooked up. In batteries of foot artillery, when serving the gun, the belt is worn without the sabre.

26. If the instructor wishes to rest the men, the sabre being drawn, he commands :

Parade—REST.

At the command REST, carry the right foot 6 inches to the rear, the left knee slightly bent, the body upright on the right leg ; the back of the sabre resting in the hollow of the right arm ; the hands being crossed in front, the left hand over the right.

At the command ATTENTION, resume the proper position with sabre drawn.

When the sabre is not drawn, the cannoneer, at the command *Parade*—REST, assumes the same position as with sabre drawn, except that instead of crossing the hands in front he folds the arms over the chest.

27. After the manual of the sabre has been taught, the men will be exercised in the facings and marchings with the sabre drawn.

ARTICLE SECOND.

THE GUN DETACHMENT.

28. THE cannoneers of a piece when united for the service of the gun, or for the preliminary instruction, constitute a *detachment*, which is composed ordinarily of eight men, commanded by the gunner.

29. A *rank* is composed of men abreast; a *file*, of men placed one behind the other.

30. The cannoneers fall in in two ranks, 18 inches between the ranks; elbows slightly touching; and in such manner that they may be told off to the duties at the piece for which they are best fitted. This of course does not apply to recruits; each of whom must be taught the duties of every number under all circumstances.

The gunner tells the detachment off from the right, No. 1 being on the right of the rear rank; No. 2 on the right of the front rank; No. 3 on the left of No. 1; No. 4 on the left of No. 2, and so on, the even numbers being in the front, and the odd numbers in the rear rank. He then takes post on the right of the front rank. The chief of caisson, who, as well as the gunner, should be a corporal, is told off as No. 8 of the gun detachment. When the detachment is composed of more or less than eight men, he should be the highest even number.

When the chief of the piece is present and not the instructor, he performs the duties and takes the position of the gunner, who then takes post 1 yard in rear of the right file, and acts as file closer, except when the chief of piece is out of ranks, when the gunner resumes his post.

31. Movements of breaking and formation are first executed from a halt, that they may be better understood. The men should change ranks every day, that they may become equally accustomed

to both, and each movement should be repeated by the left after being properly executed by the right.

TO FORM IN ONE RANK.

32. The instructor commands:

1. *Detachment, left into single rank.* 2. MARCH.
3. HALT. 4. *Right-DRESS.* 5. FRONT.

At the first command, the even numbers face to the left; and, at the command MARCH, step off. At the command HALT, given when the man on the right of the front rank is opposite the left elbow of the man on the left of the rear rank, they all halt and face to the front. At the command DRESS, the odd numbers step forward, and all align themselves on the gunner, who has remained in his position. At the command FRONT, all cast their eyes to the front.

ALIGNMENTS.

33. **To the front.** Two or more files of the right are moved forward 3 yards and aligned by the commands *Two* (or—) *right files forward*—MARCH—HALT—*Right-DRESS.* The instructor then commands:

1. *By file, Right-DRESS.* 2. FRONT.

At the command DRESS, the men move forward successively, casting their eyes to the right as prescribed in No. 4, halt short of the line, and dress forward until standing squarely to the front and touching the elbow of the man on the right, they see the breast of the second man on that side. Each executes the movement when the preceding one arrives on the line, so that but one file aligns itself at a time. The command FRONT is given when the last file is aligned.

34. **To the rear.** Two or more files are moved backwards 2 yards and aligned by the commands *Two* (or —) *right files backward*—MARCH—HALT—*Right-DRESS.* The instructor then commands:

1. *By file, right backward-DRESS.* 2. FRONT.

At the command DRESS, each file takes the backward step in

succession, casting his eyes to the right, passes a little to the rear of the new line, and then dresses forward as prescribed in No. 33.

The detachment is aligned to the left on the same principles.

35. The detachment being in line, to dress it forward, the instructor places one or more files on which he wishes to align it in position, and commands :

1. *Detachment, right (or left) DRESS.* 2. FRONT.

At the command DRESS, all the cannoneers align themselves promptly in the direction indicated.

The detachment is dressed to the rear upon the same principles at the command :

1. *Detachment, right (or left) backward-DRESS.* 2. FRONT.

DIRECT MARCH IN SINGLE FILE.

36. The command is given :

1. *Detachment, right (or left) FACE.* 2. *Column Forward.*
3. MARCH.

At the command FACE, the cannoneers face to the right, (or left,) and at the command MARCH, they step off together. Each man keeps his distance from the one who precedes him, and remains exactly behind him. The men must not turn their heads, nor look at the feet of the men in front, or they will lose distance. The shoulders should be kept square, and a swinging motion avoided.

37. To halt, when marching by file, the command is given :

1. *Column.* 2. HALT.

At the second command, all halt in their positions.

The instructor will point out to those who have lost distance the evils it creates, and cause them to resume their proper places.

38. To face to the proper front, the instructor commands :

1. *Front face.* 2. *Right (or left) DRESS.* 3. FRONT.

At the command FACE, each man faces to the front—by a left face, if the detachment has been faced to the right; and by a right face, if it has been faced to the left.

CHANGE OF DIRECTION IN FILE.

39. The detachment marching by file, in single rank, the instructor commands :

1. *By file, right (or left.)* 2. MARCH. 3. FORWARD.

At the command MARCH, the leading man turns in the direction indicated without changing the step; and at the command FORWARD, given as soon as he turns, moves to his front. He is followed by the others in succession, who turn upon the same ground.

OBLIQUE MARCH IN FILE.

40. The detachment marching by file, the instructor commands :

1. *Cannoneers, right (or left) oblique.* 2. MARCH.

The movement is performed as prescribed in No. 16; the men keeping in such position in regard to those in front of them that the command FORWARD will cause them to move accurately in file in the primitive direction.

The oblique march is practised from a halt before being executed whilst marching, the commands being :

1. *Cannoneers, right (or left) oblique* FACE. 2. *Column*—MARCH.

DIRECT MARCH IN LINE.

41. The detachment being correctly aligned, the instructor commands :

1. *Detachment, forward.* 2. MARCH. 3. *Guide right (or left.)*

At the command MARCH, all step off, taking care to keep the touch of the elbow towards, and to dress on, the guide; to yield to pressure coming from, and to resist all pressure towards him.

If the touch of the elbows is lost, it must be regained gradually.

The guide will be the gunner, or the man on the flank indicated.

42. To halt the detachment, the instructor commands :

Detachment—HALT.

The detachment is then aligned by the appropriate commands.

WHEELINGS.

43. There is but one wheel, that on a movable pivot. In wheeling, the pivot man describes an arc of a circle, clearing the pivot 18 inches. The conductor of the marching flank lengthens the step as much as possible, the others taking steps according to the positions they occupy, and touching with the elbow towards the pivot. The conductor should measure with his eye the arc he is to pass over, so that the files should not be too open nor too close; for this purpose he turns his head occasionally towards the pivot, the cannoneers turn theirs slightly towards the marching flank to keep aligned, yield to pressure coming from the direction of the pivot, and resist that from the opposite direction. When they have opened or closed too much, they will regain distances gradually.

44. The detachment being in line, at a halt, or in march, the instructor commands:

1. *Detachment, in circle, right wheel.* 2. MARCH.

At the command MARCH, the cannoneers take the wheeling steps. They turn the head slightly towards the marching flank, taking care not to open or close the files too much, and to keep aligned. The pivot man, clearing the pivot 18 inches, regulates himself on the marching flank. The instructor sees that the men avoid all pressure in the ranks, and regulates the steps of the different files. After several wheels have been executed, he commands:

1. *Detachment—HALT.* 2. *Left-DRESS.* 3. FRONT.

In the first lessons to recruits, an instructed man will be placed on the outside of the pivot flank. At the command MARCH, he will turn upon his ground in marking time, so as to serve as a guide to the pivot man.

The wheel in circle to the left is executed on the same principles.

THE WHEEL.

45. The detachment being in line, at a halt or in march, to

place it in a position perpendicular to the existing front, the instructor commands :

1. *Detachment, right (or left) wheel.* 2. MARCH.
3. HALT. 4. *Left (or right) dress.* 5. FRONT.

Which is executed as in the wheel in circle, the instructor giving the command HALT, when the wheel is nearly completed.

In the wheel to the right, when the gunner is on the pivot flank, he marks time in turning to the right on his own ground at the command MARCH.

THE REVERSE.

46. The detachment being in line at a halt or in march, to place it faced to the rear, the instructor commands :

1. *Detachment, right (or left) reverse.* 2. MARCH.
3. HALT. 4. *Left (or right) dress.* 5. FRONT.

Which is executed as prescribed in No. 44, the detachment describing only a half circle, and the command HALT being given when the reverse is nearly completed.

47. In all wheelings, when it is desired to move forward at their completion, instead of the command HALT, etc., the commands will be FORWARD, *Guide right (or left.)* The command FORWARD is given as soon as the detachment is in the new direction, and is followed by the command for the guide. All resume the alignment without too much precipitation.

TO FORM THE DETACHMENT IN TWO RANKS.

48. The instructor commands :

1. *Right into two ranks.* 2. MARCH.
3. *Right-dress.* 4. FRONT.

At the first command the odd numbers take two steps to the rear; the even numbers face to the right, and at the command MARCH, move forward until opposite the rear rank men of their files, when they halt and face to the front.

At the command *Right-dress*, the detachment is aligned to the right.

49. The detachment having been formed in two ranks, the foregoing movements are executed. In wheeling, the rear rank men cover and conform their movements to those of their file leaders.

50. When the detachment marches *by a flank*, that is, when the men of each rank are formed in file, the even numbers are guides; they preserve the proper distance and keep in the direction of those who precede. The odd numbers touch lightly the elbows of their proper file leaders, and dress on them. In the changes of direction, the man on the side towards which the turn is made executes it as already prescribed; the man on the opposite side lengthens the step in turning, and keeps up the touch of the elbow.

In the *oblique*, the men on the side towards which the oblique is made are guides; the men of the opposite side regulate their movements accordingly, each following the guide in front of his own and keeping in such position with regard to the latter, that at the command FORWARD, they will be abreast, elbows touching.

In marching *in line*, the guide is the gunner, or the front rank man of the flank indicated; the rear rank men will carefully cover their file leaders, and when the distance between the ranks is lost regain it gradually. They will be practised, whilst marching in line, in marking time, and changing step. When they lose the step, the means prescribed in No. 12 are used to regain it.

TO MARCH BY A FLANK.

51. **To the right or left.** The detachment marching in line, the instructor commands:

1. *Detachment, by the right (or left) flank.* 2. MARCH.
3. FORWARD.

At the command MARCH, each man turns in the direction indicated and steps off.

The march in line in the primitive direction is resumed at the commands:

1. *Column, by the left (or right) flank.* 2. MARCH.
3. FORWARD. 4. *Guide right (or left.)*

52. **To the front.** The detachment marching in line, the instructor commands :

1. *Detachment, by the right flank by file left.*
2. MARCH. 3. FORWARD.

At the command MARCH, each man faces to the right, and the column then turns to the left. The instructor commands FORWARD as soon as the leading file has turned.

The movement is executed with the left in front at the commands :

1. *Detachment, by the left flank by file right.*
2. MARCH. 3. FORWARD.

THE DETACHMENT MARCHING BY A FLANK TO FORM LINE.

53. The column marching with the right in front, the instructor commands :

1. *Cannoneers, into line.* 2. MARCH. 3. *Guide-right.*

At the command MARCH, the first man of the front rank continues to advance. The first man of the rear rank shortens the step, and places himself behind him by obliquing to the left; the other men oblique immediately to the left, quicken the step, and form in succession in line on the left of the first, each in the rank to which he belongs. The instructor then gives the command, *Guide-right.*

When the column marches with the left in front, the movement is executed on the same principles at the commands :

1. *Cannoneers, into line.* 2. MARCH. 3. *Guide-left.*

The cannoneers obliquing to the right.

OBLIQUE IN LINE.

54. The detachment marching in line, the instructor commands :

1. *Cannoneers, left (or right) oblique.* 2. MARCH.

At the command MARCH, the cannoneers oblique in the direction ordered. The man of each rank on the flank towards which the oblique is made is the guide of that rank, the guide of the rear rank governing himself by that of the front as prescribed in

No. 40. The other men, no longer keeping up the touch of the elbows, glance towards their guide, and keep in such position that their shoulders may be in rear of those of the next man of their rank in that direction.

The primitive direction is resumed at the command

FORWARD.

At this command, if the oblique has been properly executed, the detachment will move accurately in line in its original direction. The guide reverts, without further orders to the side on which it was when the oblique was ordered; but the instructor may add the command *Guide right*, or *Guide left*, at his discretion.

TO MARCH TO THE REAR.

55. The detachment being in march, in line, or in column, the instructor commands:

1. *Cannoneers, to the rear.* 2. MARCH. 3. FORWARD.

Which is executed as prescribed in No. 15. When the detachment is marching in line, the instructor adds the command for the guide.

If the detachment is at a halt, the cannoneers are first faced to the rear, and then put in motion by the commands:

1. *Forward.* 2. MARCH.

When the desired distance to the rear has been gained, the detachment is halted and resumes its primitive front at the command:

Cannoneers, rear-FACE.

If, whilst marching to the rear, the instructor wishes to march to the front again without halting, he commands:

1. *Cannoneers, to the rear.* 2. MARCH. 3. FORWARD.

And, when marching in line, adds the command for the guide.

TO MARCH BACKWARDS.

56. The detachment being in line at a halt, the instructor commands:

1. *Detachment, backward.* 2. MARCH.
3. *Guide-RIGHT (OR LEFT.)*

At the command **MARCH**, all take the backward step, dressing on the guide, until the instructor commands:

1. *Detachment*, **HALT**.
2. *Right* (or *left*) **DRESS**.
3. **FRONT**.

As this movement is seldom used, the men will not be required to move more than 12 or 15 steps at a time.

TO OPEN AND CLOSE THE RANKS.

57. **To open the ranks**, the instructor commands:

1. *To the rear open order*.
2. **MARCH**.
3. *Right*-**DRESS**.
4. **FRONT**.

At the command **MARCH**, the rear rank briskly marches backwards 5 yards and halts, each cannoneer accurately covering his file leader. At the command **DRESS**, the rear rank is aligned to the right.

58. **To close the ranks**, the instructor commands:

1. *Close order*.
2. **MARCH**.

At the command **MARCH**, the rear rank closes on the front.

59. After the foregoing movements are properly executed with the sabres sheathed, they will be executed with drawn sabres.

60. When the ranks are closed, at the first part of the command *Draw-SABRE* or *Return-SABRE*, the rear rank marches backwards 2 yards, and, after the movement is executed, closes again without a command.

EXECUTION OF THE MOVEMENTS AT THE DOUBLE-QUICK.

61. The movements, as prescribed, are made at the ordinary rate of 110 steps in a minute. Whenever, during the movement, it is desired to increase their rapidity, the instructor commands:

1. *Double-quick*.
2. **MARCH**.

At the command **MARCH**, the cannoneers take steps at the rate of 165 in a minute, and continue them until the command,

1. *Quick*.
2. **MARCH**,

is given, when they resume the ordinary rate of 110 steps to the minute.

To commence the movement at the double-quick, the instructor

adds the command *double-quick* to the command of preparation, immediately preceding that of execution.

To move forward in line for instance, at a double-quick, from a halt, the instructor commands :

1. *Detachment, forward—double-quick.*
2. MARCH. 3. *Guide right (or left.)*

This rule is general for the movements when dismounted.

THE PLATOON.

62. The instruction laid down for the detachment is equally applicable to the platoon, by substituting the word *platoon* for the word *detachment*. This instruction is given by the chief of the piece.

For the instruction of the platoon, the men are formed in two ranks, the gunner on the right; the chief of caisson is the front rank man of the left file.

The platoon is divided into detachments of eight men each, who are numbered as in the gun detachment.

In forming, the gun detachment should fall in on the right, the drivers on the left.

SABRE EXERCISE.

63. The object of the moulinet is to render the joints of the arm and wrist supple, and as it adds to the confidence of the men when isolated, by increasing their dexterity, they should first be exercised at it, as a preparation for the other motions.

Each lesson is, therefore, commenced and ended with moulinets, executed with a quickness proportioned to the progress of the cannoneer. The instructor pays particular attention that the men do not employ a degree of force in the sabre exercise, which not only is less necessary than skill and suppleness, but which is even prejudicial. He observes, also, that they do not lean to one side, in such a manner as to lose the seat if mounted; he requires, more especially in the motion of the sabre to the rear, that the blade shall not fall too near the body, for fear of wounding the horse. In describing a circle, the flat of the blade should be to the side,

and the edge to the front, and it should be so directed as not to touch either the horse's head or his haunches, or the knees of the rider.

When the cannoneers execute all the motions with regularity, the instructor requires each cut to be given without decomposing it; the last syllable of a command is the signal for the quick execution of it. All the cuts are then terminated by a half moulinet, which brings back to the position of GUARD.

Thrusts should always be used in preference, as they require less force, and their result is more prompt, sure, and decisive. They should be directed quickly *home* to the body of the adversary, the sabre being held with the full grasp, the thumb pressing against the guard in the direction of the blade.

The parries against the lance are the same as against the point.

64. The instructor explains what is meant by *right and left side of the gripe*; by *tierce*, and by *quarte*.

The right side of the gripe is the side opposite to the guard; the thumb and fingers close over it when the hand grasps the hilt.

The left side of the gripe is the side next to the guard, and lies in the palm of the hand.

Tierce is the position in which the edge of the blade is turned to the right, the nails downwards.

Quarte is the position in which the edge of the blade is turned to the left, the nails upwards.

To rest, the instructor conforms to what is prescribed in No. 1. In this case he causes the sabre to be returned.

TO OPEN FILES.

65. For the sabre exercise, the instructor opens the ranks of the platoon, or forms it in one rank, causes the sabres to be drawn, and commands:

1. *By the left (or right)*—OPEN FILES.
2. MARCH.
3. *Right (or left)* DRESS.
4. FRONT.

At the command **OPEN FILES**, all face to the left except the first file.

At the command **MARCH**, the men step off together. The second man from the right, after having marched 4 yards, halts, fronts by a right face, and dresses on the right file, who has not moved. The others continue the march, and, each one glancing over his right shoulder, halts in succession, and fronts when he has arrived at his place, which is 4 yards from that of the man next behind him. The rear rank men regulate themselves by their file leaders, and remain exactly behind them.

When the third man from the right has faced to the front, the instructor commands *Right-DRESS*, the gunner dresses the rear rank; and the instructor commands **FRONT**.

During the exercise, the gunner superintends the rear rank.

To open the files without too much extending the front, the instructor forms the platoon in single rank, or else opens the ranks by marching the front rank 12 yards to the front, or the rear rank 12 yards to the rear.

He then commands:

1. *To the front*—**OPEN FILES**.
2. **MARCH**.
3. *Right-DRESS*.
4. **FRONT**.

At the command **MARCH**, Nos. 1 and 2 move 9 yards, Nos. 3 and 4 move 6 yards, and Nos. 5 and 6 move 3 yards to their front, and halt. At the third command, each dresses on his own line.

66. The files being opened, the instructor commands:

GUARD.

At the command **GUARD**, carry the right foot 2 feet from the left, the heels on the same line; place the left hand, closed, 6 inches from the body, and as high as the elbow; the fingers towards the body, the little finger nearer than the thumb, (*position of the bridle hand*.) At the same time place the right hand in tierce, at the height of, and 3 inches from the left hand,

the thumb extended on the back of the gripe; the little finger by the side of the others; the point of the sabre inclined to the left, and 2 feet higher than the hand.

THE MOULINETS.

67. The instructor commands:

Left—MOULINET.

1 pause; 2 motions.

At the command MOULINET, extend the right arm to the front to its full length, the hand in tierce, and as high as the eyes.

TWO. Lower the blade in rear of the left elbow; graze the horse's neck quickly, describing a circle from rear to front, and return to the position of GUARD.

Right—MOULINET.

1 pause; 2 motions.

68. At the command MOULINET, extend the right arm to the front to its full length, the hand in quarte, and as high as the eyes.

TWO. Lower the blade in rear of the right elbow; graze the horse's neck quickly, describing a circle from rear to front, and return to the position of GUARD.

69. To execute the moulinet without stopping, if the instructor wishes to begin by the left, he commands:

Left and right—MOULINET.

1 pause; 2 motions.

If he wishes to begin by the right, he commands:

Right and left—MOULINET.

1 pause; 2 motions.

At either of these commands, the cannoneers, commencing from the position of GUARD, execute alternately what is laid down in Nos. 67 and 68, without stopping at any motion.

Rear—MOULINET.

1 pause; 2 motions.

70. At the command MOULINET, raise the arm to the right and rear to its full extent, the point of the sabre upwards, the

edge to the right, the thumb extended on the back of the gripe, the body slightly turned to the right.

TWO. Describe a circle in rear from left to right, the hand as far as possible from the body, and return to the position of GUARD.

When the cannoneers execute the moulinets well, the instructor requires them to execute several in succession, until the command GUARD.

THE THRUST.

71. To execute the thrust, the instructor commands:

In tierce—POINT.

2 pauses; 3 motions.

At the command POINT, raise the hand in tierce as high as the eyes, throw back the right shoulder, carrying the elbow to the rear; the point of the sabre to the front, the edge upwards.

TWO. Thrust to the front, extending the arm to its full length.

THREE. Return to the position of GUARD.

In quarte—POINT.

2 pauses; 3 motions.

72. At the command POINT, lower the hand in quarte near the right hip, the thumb extended on the right side of the gripe, the point a little higher than the wrist.

TWO. Thrust to the front, extending the arm to its full length.

THREE. Return to the position of GUARD.

Left—POINT.

2 pauses; 3 motions.

73. At the command POINT, turn the head to the left, draw back the hand in tierce towards the right, at the height of the neck, the edge upwards, the point directed to the left.

TWO. Thrust to the left, extending the arm to its full length.

THREE. Return to the position of GUARD.

Right—POINT.

2 pauses; 3 motions.

74. At the command POINT, turn the head to the right,

carry the hand in quarte near the left breast, the edge upwards, the point directed to the right.

TWO. Thrust to the right, extending the arm to its full length.

THREE. Return to the position of GUARD.

Rear—POINT.

2 pauses; 3 motions.

75. At the command POINT, turn the head to the right and rear, bring the hand in quarte opposite to the right shoulder, the arm half extended, the blade horizontal, the point to the rear, the edge upwards.

TWO. Thrust to the rear, extending the arm to its full length.

THREE. Return to the position of GUARD.

Against infantry, Left—POINT.

2 pauses; 3 motions.

76. At the command POINT, turn the head to the left, raise the hand in tierce near the neck, the point of the sabre directed at the height of the breast of a man on foot.

TWO. Thrust down in tierce.

THREE. Return to the position of GUARD.

Against infantry, Right—POINT.

2 pauses; 3 motions.

77. At the command POINT, turn the head to the right, carry the hand in quarte near the right hip, the point of the sabre directed at the height of the breast of a man on foot.

TWO. Thrust in quarte.

THREE. Return to the position of GUARD.

THE CUT.

78. To execute the cut, the instructor commands:

Front—CUT.

2 pauses; 3 motions.

At the command CUT, raise the sabre, the arm half extended, the hand a little above the head, the edge upwards, the point to the rear and higher than the hand.

TWO. Cut, extending the arm to its full length.

THREE. Return to the position of **GUARD**.

Left—CUT.

2 pauses; 3 motions.

79. At the command **CUT**, turn the head to the left, raise the sabre, the arm extended to the right, the hand in quarte, and as high as the head, the point higher than the hand.

TWO. Cut diagonally to the left.

THREE. Return to the position of **GUARD**.

Right—CUT.

2 pauses; 3 motions.

80. At the command **CUT**, turn the head to the right, carry the hand opposite to the left shoulder, the point of the sabre upwards, the edge to the left.

TWO. Extend the arm quickly to its full length, and give a back-handed cut horizontally.

THREE. Return to the position of **GUARD**.

The cuts Nos. 78, 79, and 80 are also used against infantry, observing to direct them vertically.

Rear—CUT.

2 pauses; 3 motions.

81. At the command **CUT**, turn the head to the right, throwing back the right shoulder; carry the hand as high as, and opposite to the left shoulder, the sabre perpendicular, the edge to the left.

TWO. Extend the arm quickly to its full length, and give a back-handed cut, horizontally, to the rear.

THREE. Return to the position of **GUARD**.

Right, in tierce and quarte—CUT.

3 pauses; 4 motions.

82. At the command **CUT**, execute the first motion of *right cut*, No. 80.

TWO. Execute the second motion of *right cut*.

THREE. Turn the hand in quarte, and cut horizontally.

FOUR. Return to the position of **GUARD**.

Left, in quarte and tierce—CUT.

3 pauses; 4 motions.

83. At the command CUT, execute the first motion of *left cut*, No. 79.

TWO. Execute the second motion of *left cut*.

THREE. Turn the hand in tierce, and cut horizontally.

FOUR. Return to the position of GUARD.

Rear, in tierce and quarte—CUT.

3 pauses; 4 motions.

84. At the command CUT, execute the first motion of *rear cut*, No. 81.

TWO. Execute the second motion of *rear cut*.

THREE. Turn the hand in quarte, and cut horizontally.

FOUR. Return to the position of GUARD.

THE PARRY.

85. To execute the parry, the instructor commands:

In tierce—PARRY.

1 pause; 2 motions.

At the command PARRY, carry the hand quickly a little to the front and right, the nails downwards, without moving the elbow, the point inclined to the front, as high as the eyes, and in the direction of the right shoulder; the thumb extended on the back of the gripe, and pressing against the guard.

TWO. Return to the position of GUARD.

In quarte—PARRY.

1 pause; 2 motions.

86. At the command PARRY, turn the hand, and carry it quickly to the front and left, the nails upwards, the edge to the left, the point inclined to the front, as high as the eyes, and in the direction of the left shoulder; the thumb extended on the back of the gripe, and resting against the guard.

TWO. Return to the position of GUARD.

For the head—PARRY.

1 pause; 2 motions.

87. At the command **PARRY**, raise the sabre quickly above the head, the arm nearly extended, the edge upwards, the point to the left, and about 6 inches higher than the hand.

The hand is carried more or less to the right, left, or rear, according to the position of the adversary.

Two. Return to the position of **GUARD**.

Against infantry, right—PARRY.

2 pauses; 3 motions.

88. At the command **PARRY**, turn the head to the right, throwing back the right shoulder, raise the sabre, the arm extended to the right and rear, the point upwards, the hand in tierce; the thumb extended on the back of the gripe, the edge to the left.

Two. Describe a circle quickly on the right, from rear to front, the arm extended; turn aside the bayonet with the back of the blade, bringing the hand as high as the head, the point upwards.

THREE. Return to the position of **GUARD**.

Against infantry, left—PARRY.

2 pauses; 3 motions.

89. At the command **PARRY**, turn the head to the left, raise the sabre, the arm extended to the front and right, the point upwards, the hand in tierce; the thumb extended on the back of the gripe, the back of the blade to the front.

Two. Describe a circle quickly on the left, from front to rear, along the horse's neck, the arm extended; turn aside the bayonet with the back of the blade, bringing the hand still in tierce above the left shoulder.

THREE. Return to the position of **GUARD**.

THE THRUST AND CUT COMBINED.

90. When the cannoneers begin to execute correctly the above cuts, thrusts, and parries, the instructor requires them to make the application of them by combined motions, as follows:

In tierce—POINT, AND FRONT CUT.

In quarte—POINT, AND FRONT CUT.

Left—POINT, AND CUT.

Right—POINT, AND CUT.

Rear—POINT, AND CUT.

Against infantry, right—POINT AND CUT.

Against infantry, left—POINT AND CUT.

Carry—SABRE.

91. As it is prescribed in No. 22, and carry the right foot by the side of the left.

92. When the instructor wishes to form the platoon, he commands:

1. *To the right (or left)*—CLOSE FILES.

2. MARCH.

At the command CLOSE FILES, the men all face to the right, (or left,) except the file on which they close.

At the command MARCH, they step off together, and each one fronts in succession, by a left (or right) face, when he has closed up to the man who precedes him.

After the ranks are formed, the instructor closes and dresses them.

If the files have been opened to the front, the instructor commands:

1. *Close files.* 2. MARCH.

At the command *close files*, Nos. 7 and 8 stand fast, the other numbers face to the rear.

At the command MARCH, all close on Nos. 7 and 8, each in his own rank, and face about.

The ranks are then formed, or closed, and the platoon aligned.

ARTICLE THIRD.

MANUAL OF THE PIECE.

93. THE instructor should bear in mind that, in every change of numbers at the gun, each recruit has to learn different duties, and to handle different implements from those he was previously engaged with; and these again vary with the several natures of ordnance and machines which an artilleryman must use. It is impossible that such a variety of exercises can be well executed, or even remembered, unless the recruit is made to comprehend the object of the various duties he is called upon to perform.

For the purpose of instructing the recruit, each detachment is to be formed in front of the piece, unlimbered, and the different numbers are to be called upon, successively, to perform their respective duties *in detail*; while the rest of the detachment look on and observe their motions. When it is found difficult to make the recruit sensible of the defect of his position, etc., the instructor will place himself, or another recruit, in the correct position.

94. Nine men, including the gunner, are necessary for the service of a field piece. When, from necessity, the detachment consists of less than nine, the higher numbers are struck out, and additional duties are imposed upon those remaining.

POSTS OF THE CANNONEERS. PIECE UNLIMBERED.

95. The gunner is at the end of the trail handspike; Nos. 1 and 2 are about 2 feet outside the wheels, No. 1 on the right, and No. 2 on the left; with howitzers, rather in rear of the muzzle; with guns, in line with the front part of the wheels; Nos. 3 and 4 are in line with the knob of the cascable, covering Nos. 1 and 2; No. 5 is 5 yards in rear of the left wheel; No. 6 in rear of the limber, and No. 7 on his left, covering No. 5; No.

8, the chief of the caisson, is 4 yards in rear of the limber, and on its left; all face to the front.

The chief of the piece is opposite the middle of the trail handspike, outside and near the left cannoneers. In actual firing he takes his place on the right or left, where he can best observe the effect of the shot.

LOADING AND FIRING.

96. The piece is taken at the drill ground, unlimbered, and prepared for action; the limber in position behind the piece, and facing towards it; the end of the pole 6 yards from the end of the trail handspike.

97. **Commanding and Pointing.** The gunner gives all executive commands in action. He is answerable that all the numbers perform their duties correctly. He communicates the orders which he receives for the kind of ammunition to be fired; sending to No. 6 the time or distance for each round, when firing shells or spherical case shot. He should, when the firing is slow, see that each fuze is properly prepared, and make such corrections as are necessary; for this purpose he, as well as No. 6, should be provided with a fuze-gouge.

On receiving the command, or signal to commence firing, he gives the command **LOAD**; takes hold of the handspike at the end with his right hand, and at the centre with his left; places his left knee against the left hand, bending over it, the right knee being slightly bent; looks over the top of the piece, and gives the direction. He then steps to the breech to give the elevation, which he does by placing the hausse on its seat, taking hold of a handle of the elevating screw, drawing back his right foot, bending over his left knee, and sighting through the slit in the hausse. In the drill of recruits, the gunner should be made to name the elevation and range before stepping up to the breech.

When the piece is loaded and pointed, he removes the hausse, gives the command **READY**, and, stepping clear of the wheel to that side where he can best observe the effect of his shot, gives

the command FIRE. As soon as the piece has been fired, he causes it to be run up to its former place if necessary.

When the instructor, instead of giving the command COMMENCE FIRING, gives that of LOAD, the gunner repeats it, and performs the same duties as before, except that he does not command FIRE until the firing is ordered to commence. After the command COMMENCE FIRING is given, the action is continued by the gunner, without further commands from the instructor, until the firing is ordered to cease. When the commands are all given by the instructor, as in *loading by detail*, the gunner performs the same duties, but without repeating the commands.

98. The detachment being formed in front of and facing the piece, the instructor commences by giving the following explanations:

The term **Cannon** embraces all kinds of heavy ordnance, GUNS, HOWITZERS, MORTARS; each is mounted on a *carriage*; and each field carriage has a *limber*.

The term **PIECE** is applied to the *cannon*, and is also used to designate it in union with its carriage, with or without the limber attached.

The *front* of a piece, when *limbered*, or prepared for moving, is the direction in which the pole points; when *unlimbered*, or prepared for action, it is the direction in which the gun points; the *right* and *left* are in each case determined accordingly.

He then repeats the names of the following objects, indicating each of them.

The **Limber**: *ammunition chest, lid, handles*; **POLE**: *pole-yoke, branches, sliding ring, pole prop, and chain*; **WHEEL**: *spokes, felloes, nave, tire*; **PINTLE-HOOK**, and *key*.

The **Gun carriage**: *handspike, pointing rings, elevating screw, handles, sponge hook*.

The **Gun**, or **Howitzer**, giving explanations of the parts:

The *bore* is the interior hollow cylinder which receives the charge.

The *muzzle* is the entrance of the bore.

The *face* is the front plane terminating the piece.

The *vent* is the hole through which fire is communicated to the charge.

The *trunnions* are the projecting cylinders which support the gun.

The instructor then calls No. 1 to the right side of the piece, and indicates the following parts with his hand, after naming them. The SPONGE and RAMMER: *staff, sponge, rammer head, ferrules.* GUN: *bore, muzzle, face, vent.* He then commands:

TO YOUR POSTS.

99. **Sponging and Ramming.** Until the command LOAD, No. 1 stands square to the front, in line with the front part of the wheels, holding the sponge about the middle of the staff in his right hand, and trailing it at an angle of 45°, sponge head up. The instructor commands:

By detail—LOAD.

3 pauses; 4 motions.

At this command No. 1 faces to the left, steps obliquely to the right with his right foot, without moving his left, and at the same time brings the sponge smartly to a perpendicular position by drawing his right hand up in line with the elbow. The sponge is grasped firmly in the hand, and the rammer head kept just over the right toe, the elbow close to the side.

Two. He steps obliquely to the left with his left foot, planting it about half way between the piece and the wheel, and opposite the muzzle; bringing the sponge at the same time across his body to the left, so that his right hand may be opposite the middle of the body, the sponge staff being inclined at an angle of 45° across the front of it.

THREE. He takes a side step to the right of 30 inches, and bending his right knee, brings the sponge to a horizontal position, extending the hands to the ends of the staff, the sponge head to the left, the back of his right hand up, and that of his left down, the sponge head against the face of the piece.

FOUR. He inserts the sponge head, drops his left hand behind his thigh, shoulders square, feet equally turned out, straightens

the right knee, and, bending over the left, forces the sponge home.

Sponge.

3 pauses; 4 motions.

100. At this command No. 1 fixes his eye on the vent to see that it is closed, gives two turns to the sponge, taking great care to press it at the same time against the bottom of the bore.

Two. He draws out the sponge, at the same time straightening his left knee, and bending his right; seizes the staff near the sponge head with his left hand, back of the hand down, and places the sponge against the face of the piece.

THREE. He turns the sponge by bringing his hands together in the middle of the staff, giving it a cant with each hand, throwing the sponge head over, at the same time turning his wrist, which brings the staff horizontal, and extending his hands to the ends of the staff, back of the left up, that of the other down.

During the whole time of sponging, No. 1 keeps his eye on the vent. If at any time it is not closed, he will discontinue the manœuvre, and command STOP VENT.

FOUR. He introduces the rammer head into the muzzle, as soon as No. 2 has inserted the charge, and joins his left hand to his right, casting his eyes to the front.

RAM.

2 pauses; 3 motions.

101. At this command No. 1 rams home, throwing the weight of his body with the rammer; bending over his left knee, and passing his left arm, with the elbow slightly bent, and back of the hand up, in a horizontal position over the piece, until it points in the direction of the left trunnion; the right shoulder thrown back, and the eyes cast towards the front until the cartridge is home.

Two. He jerks the sponge out with his right hand, allowing it to slide through the hand as far as the middle of the staff, when he grasps it firmly, and seizing it close to the rammer head with the left hand, back of the hand up, places the rammer head

against the face of the piece; both knees straight; eyes to his own front.

THREE. He then draws the sponge close to his body, and immediately steps back outside the wheel, first with the right, then with the left foot; so that when the right foot is brought to it the right hip may be on a line with the front of the wheel. In drawing the right foot to the left, he gives the sponge a cant with his left hand, at the same time quitting it, and brings the sponge to a perpendicular position in the right hand, the rammer head resting on the right toe.

102. Ready. At this command, which is given as soon as the piece is loaded, or the firing about to commence, No. 1 breaks well off to his left with the left foot, bending the left knee, and straightening the right leg, drops the end of the sponge staff into the left hand, back of the hand down, and fixes his eyes on the muzzle.

The heels should be parallel to the wheel, the body erect on the haunches, and the sponge and rammer held in both hands in a horizontal position, sponge-head to the left.

The piece having been fired, No. 1 rises on his right knee, and returns to his position, as in the third motion of **RAM**.

At the command **LOAD**, he steps in and performs his duties in the same manner as before.

103. When the loading is not *by detail*, No. 1 goes through all his duties at the command **LOAD**, returns to his position outside the wheel, as given in the third motion of **RAM**; breaks off at the command **READY**, and at the flash of the gun rises, steps in, and performs his duties in the same manner as before. This he continues until the command **CEASE FIRING** is given, at which command he resumes the position: *To your posts*. If the sponging has been commenced when the command **CEASE FIRING** is given, it is completed before No. 1 resumes his post.

In sponging and ramming, if the length of the piece requires it, the sponge and rammer are to be pressed home in two motions, No. 1 extending his right hand to the end of the staff, as soon as it reaches the muzzle.

In sponging *howitzers*, No. 1 presses the sponge to the bottom of the chamber, which should be well sponged out. He wipes the bore by rubbing its whole surface, without allowing the sponge to turn in his hands.

REMARKS ON THE DUTIES OF NO. 1.

104. The position of the left foot will not be considered as absolute; it is given as the usual one, and may be modified according to the calibre of the piece, and height of the man. The same remarks will apply to the distance between the feet. They will be placed in such position, and at such distance from each other, as will enable the man to perform his duties with the most ease and steadiness, and at the same time exert his full strength, which will always be required after firing a few rounds, especially when a new sponge is used.

One object of joining the left hand to the right, and casting the eyes to the front whilst ramming, is to refuse the right shoulder; and to secure this object, the left hand, when it passes over the piece, is not carried further back than the direction indicated. This will keep the shoulders in a line parallel with their position, at the commencement of the movement, until the cartridge is set home, and thus guard against fatal results in case of a premature discharge.

105. **Loading.** The instructor places No. 2 on the left of the piece, repeats the nomenclature as for No. 1, indicates the following named objects, and explains their uses: **STRAPPED SHOT:** *cartridge, ball, sabot*; **CANISTER SHOT:** *cartridge, canister*; **SHELL, or SPHERICAL CASE SHOT:** *cartridge, case shot, or shell, fuze*. He then commands:

TO YOUR POSTS.

Until the command **LOAD** is given, as for No. 1, No. 2 remains in his position. On this command being given, he faces to his right, and by two oblique steps, corresponding to those of No. 1, the first with the left, the second at the command **Two**, with the right foot, he places himself near the muzzle of the piece. At the command **THREE**, he brings up his left foot to the side of the

right, and faces to his right, bringing his hands together to receive the ammunition from No. 5; the cartridge in the right, the shot in the left hand. As soon as the sponge is withdrawn, he faces to his left, and puts the ammunition into the muzzle, taking care that the seam of the cartridge does not come under the vent, and then steps back, commencing with his left foot, to his position outside the wheel, in the same manner that No. 1 does.

At the command **READY**, he breaks well off to his right with the right foot, bending the right knee, and straightening the left leg; the body erect on the haunches, and fixes his eyes on the muzzle.

The piece having been fired, No. 2 rises on his left leg, remains facing the piece until he hears the command **LOAD**, or observes the flash of the gun, then steps in, and performs his duty as before. At the command **CEASE FIRING**, he takes his position outside the wheel, and faces to the front.

With the *howitzer*, No. 2 puts in the charge, so that the fuze may rest against the rammer head, and No. 1 sets it home carefully.

106. Serving the vent. The instructor places No. 3 on the right of the piece, indicates the following objects, and explains their uses:

TUBE POUCH; THUMB STALL; PRIMING WIRE; GUNNERS' GIMLET; FRICTION PRIMER; LANYARD: lanyard hook; VENT: vent field; BREECH: cascable, knob, and neck of cascable. He then commands:

TO YOUR POSTS.

No. 3 stands in line with the knob of the cascable, covering No. 1, the priming wire in his right hand, thumb through the ring, the thumb stall on the left thumb, the tube pouch fastened to the waist.

Load. At this command he steps to his left, wipes the vent field with the thumb stall, which he then holds pressed upon the vent, keeping his elbow raised; his fingers on the left side of the piece, so as to allow the gunner to point over his thumb; the right hand on the tube pouch. When the piece is sponged, and

the charge inserted by No. 2, he jumps to the end of the trail handspike, and, seizing it with both hands, prepares to move it to the right or left, on a signal from the gunner, who taps the right of the trail for a movement to the left, and the left of the trail for a movement to the right. As soon as the piece is pointed, the gunner raises both hands as a signal to No. 3, who then resumes the position *to your posts*.

Ready. At this command, he steps in to the piece, pricks the cartridge, taking care not to move the charge, and covers the vent with his left hand as soon as the tube is inserted. At the command **FIRE**, he steps to his right, clear of the wheel, and at the flash of the gun, or at the command **LOAD**, serves vent as before.

No. 3 should be careful to keep the vent closed from the time the sponge enters the muzzle until the charge is inserted by No. 2.

107. Firing. The instructor places No. 4 on the left of the piece, equips him with a tube pouch, and repeats the nomenclature as for No. 3. He then commands:

TO YOUR POSTS.

No. 4 stands in line with the knob of the cascable, and covering No. 2.

Load. At this command, No. 4 inserts the lanyard hook into the ring of a primer, and stands fast.

Ready. At this command, he steps in with the right foot, drops the tube in the vent, takes the lanyard in his right hand, moves to the rear so far as to keep the lanyard slack, but capable of being stretched, without altering his position, which should be clear of the wheel, left foot broken to the left and rear.

Fire. As soon as No. 3 is clear of the wheel, No. 4 pulls the lanyard briskly and firmly, passing the hand, back up, in a downward direction to the rear, so as to keep the lanyard hook from flying back in the direction of the face. Should the tube fail to explode the charge, the gunner immediately commands, *Don't advance, the primer has failed*. Upon which No. 2 steps inside the wheel, close to the axletree, receives from No. 3 over the wheel a priming wire, and from No. 4 a prepared primer, pricks,

primes, and resumes his post. At the command, *Cease firing*, No. 4 secures his lanyard.

108. No. 3, as well as No. 4, should be equipped with a tube pouch, furnished with friction primers and lanyards. In the absence of No. 4, immediately after pricking the cartridge, he prepares and inserts a tube, steps to his post, faces the vent, breaks to his rear with the left foot, and at the command FIRE, discharges the piece. He then resumes his post, and tends the vent as before.

109. **Serving ammunition.** The instructor stations No. 5, covering the left wheel, 5 yards in rear of it, and No. 7 in rear of and near the left limber wheel; No. 6 is stationed in rear of the limber chest, and issues the ammunition. He is provided with a fuze-gouge, and prepares the shell and spherical case shot according to the distance or time ordered, before delivering it to No. 5.

To cut the fuze. Place the projectile between the knees, fuze uppermost, and support it with the left hand. Holding the fuze-gouge in the right hand, place the left corner of its edge close to, and on the right of the graduated mark indicating the time desired; then cut away gradually until the composition is exposed for a length about equal to the width of the gouge. Great care must be taken not to expose the composition to the left of the proper graduation mark, and to this end particularly avoid *commencing to cut* too close to the desired mark; for after the composition is once exposed it is very easy to pare away to the left, if the time has not been accurately cut. When time permits, it is well to expose the composition fully, either by cutting the opening larger, *towards the right*, or (with shells only) by cutting another opening to the right of the first. It is in all cases better to enlarge the first opening, and always by extending it towards the right.

Care must be taken not to cut the fuzes more rapidly than the demand for shells and Shrapnell shot requires.

At the command LOAD, No. 5 runs to the ammunition chest, receives from No. 7 or No. 6 a single round, the shot in the right hand, the cartridge in his left; takes it to the piece and delivers

it to No. 2; returns immediately for another round, and then halts at his post until the piece is fired. In firing shells or spherical case, he exhibits the fuze to the gunner before delivering the charge to No. 2.

When ammunition pouches are used they are worn by Nos. 5 and 7, hung from the left shoulder to the right side; the round is placed in the pouch by No. 6 or No. 7, so that the cartridge will be to the front. When it is brought up No. 5 holds open the pouch, and No. 2 takes out the round with both hands. In rapid firing, with round shot and canister, Nos. 5 and 7 may alternate in delivering the charges to No. 2, especially when the ammunition is issued direct from the caisson. At the command **CEASE FIRING**, No. 5 carries the round back to No. 6.

No. 6 will be careful not to raise the lid unnecessarily. It should be kept closed when possible. In firing shells and spherical case, he prepares each fuze as directed, assisted when necessary by No. 7. He gives No. 5 the *time* or *distance* of the fuze with each round issued, who reports to the gunner before delivering it to No. 2. At the command **CEASE FIRING**, he carefully replaces the ammunition in the chest, and secures the lid.

110. Loading by detail. For the instruction of recruits united for the service of the gun, the exercise is conducted by detail, the instructor giving all the commands. His commands are, *Load by detail*—**LOAD; TWO, THREE, FOUR: SPONGE; TWO, THREE, FOUR: RAM; TWO, THREE; READY; FIRE; CEASE FIRING.**

When the men are sufficiently instructed to go through the manual, without detail, the commands of the instructor for that purpose, are—**LOAD; COMMENCE FIRING; CEASE FIRING;** or, simply, **COMMENCE FIRING,** and **CEASE FIRING.** After the command **COMMENCE FIRING**, the action is continued as laid down for loading without detail, until the command **CEASE FIRING** is given, which is repeated by the chief of the piece and the gunner.

MOVING THE PIECE BY HAND. PIECE UNLIMBERED.

111. **To the front.** The instructor commands:

1. *By hand to the front.* 2. MARCH. 3. HALT.

At the first command, the gunner seizes the end of the handspike, and Nos. 1, 2, 3, and 4 the spokes of the wheels. No. 1, with his left hand; Nos. 2, 3, and 4 with both hands; No. 1 holds the sponge with his right hand, the staff resting upon his right shoulder, sponge head down. At the second command they move the piece forward, the gunner raising the trail until the command HALT is given, when all resume their posts.

112. **To the rear.** The instructor commands:

1. *By hand to the rear.* 2. MARCH. 3. HALT.

At the first command, the gunner, facing to the rear, seizes the handspike with his right hand; Nos. 1, 2, 3, and 4 seize the wheels as before, except that No. 1, holding the sponge in his left hand, uses his right at the wheel. At the command MARCH, they move the piece to the rear, the gunner raising the trail, until the command HALT is given, when all resume their posts.

CHANGING POSTS.

113. In order to instruct the men in all the duties at the piece, the instructor causes them to change posts.

For this purpose he commands:

1. *Change posts.* 2. MARCH.

At the command *Change posts*, the men on the right of the piece face to the rear; those who have equipments lay them down; No. 1 resting the sponge head on the nave of the wheel. At the command MARCH, each man takes the place and equipments of the man in his front.

No. 1	takes the place of	No. 3.
No. 3	“	“ of No. 8.
No. 8	“	“ of No. 6.
No. 6	“	“ of No. 7.
No. 7	“	“ of No. 5.

No. 5 takes the place of No. 4.
 No. 4 “ “ of No. 2.
 No. 2 “ “ of No. 1.

The gunner changes with one of the numbers by special direction of the instructor. A sufficient number of the most intelligent cannoneers must be kept instructed to serve as gunners.

114. **Equipments.** The gunner, who is responsible for the equipments, either distributes them from the limber chest, or they may be hung on the neck of the cascable, and distributed by him to the proper numbers, at the command TAKE EQUIPMENTS, from the instructor. He receives them again at the command REPLACE EQUIPMENTS, making such disposition of them as may be directed.

LIMBERING.

115. **To the front.** The instructor designates the following parts of the carriage: *Stock: trail, trail handles, trail plate, lunette, washer hook for handspike, large pointing ring, small pointing ring, sponge and rammer stop, sponge chain and hasp, ear plate for sponge chain hasp, handspike ring, sponge hook.*

He then commands:

LIMBER TO THE FRONT.

At this command, No. 1 steps up between the muzzle and the wheel, by the oblique steps indicated for loading; turns the staff, seizing it with the left hand, at the same time shifting his right, the back of the right up, that of the left down, and passes the sponge on its hook; rammer head to the rear, to No. 3, who receives the head, secures it against the stop, and keys it up. The piece is then brought about by the cannoneers, and the limber, inclining to the right, passes to its place in front of it, being drawn, when it is not horsed, by Nos. 6 and 7, who take hold at the end of the pole for the purpose.

To bring the piece about, the gunner and No. 5 pass to the right of the handspike, and, facing towards the left, seize it, the gunner near the end, and No. 5 at the middle, and on his right, raise the trail and carry it round to the left; Nos. 1 and 2 bear

down upon the muzzle, and Nos. 3 and 4, each using both hands, bring the wheels round; No. 3 turning the right wheel to the rear, and No. 4 the left wheel to the front. When the piece is brought about, the trail is lowered; Nos. 3 and 4 step within the wheels to avoid the limber; Nos. 1 and 2 remain at the muzzle, and the gunner and No. 5 step between Nos. 3 and 4 and the trail, the gunner first taking out the handspike, and passing it to No. 4, by whom it is put up.

As soon as the limber is in front of the piece, the gunner commands: **HALT, LIMBER UP;** upon which the limber halts, the gunner and No. 5 raise the trail by means of the handles, and, assisted by Nos. 3 and 4 at the wheels, and Nos. 1 and 2 at the head of the carriage, run the piece forward, and place the lunette upon the pintle; the gunner then puts in the key, and all take their posts; when necessary, Nos. 6 and 7 assist at the trail in bringing the piece about, and in limbering up.

116. **To the right, (or left.)** The instructor commands:

LIMBER TO THE RIGHT, (OR LEFT.)

The trail is turned to the right, (or left,) and the piece limbered up as before; the limber inclining to the right, (or left,) and taking its place by a right (or left) wheel.

117. **To the rear.** The instructor commands:

LIMBER TO THE REAR.

The limber inclines to the right, and takes its place by wheeling about to the left, and the piece is then limbered up as before.

POSTS OF THE CANNONEERS. PIECE LIMBERED.

118. Nos. 1 and 2 are opposite the muzzle; Nos. 3 and 4 opposite the knob of the cascable; the gunner and No. 5 opposite the rear, and Nos. 6 and 7 opposite the front parts of the limber wheels; No. 8 is on the left, and opposite the limber chest of the caisson. All face to the front, and cover each other in lines 1 yard from the wheels; the even numbers on the right, the odd numbers on the left. The chief of the piece is on the left, and, if not mounted, opposite the end of the pole; if mounted, he is near the leading driver, and on his left.

TO FORM THE DETACHMENT.

119. **To the front.** The instructor commands:

DETACHMENT—FRONT.

The gunner commands: *Cannoneers, forward, MARCH*; the even numbers move directly to the front; the odd numbers closing on them when clear of the piece. The gunner files them to the left, and fronts the detachment at the proper distance. No. 8 moves directly forward, and takes his place in the detachment.

To the rear. The instructor commands:

DETACHMENT—REAR.

The gunner commands: *Cannoneers, rear FACE—MARCH*. At the command *MARCH*, the odd numbers move directly to the rear, the even numbers closing on them, and the detachment is filed to the left, halted at a proper distance by the gunner, and faced to the front; No. 8 taking his proper place in the detachment.

In forming detachments in line, they are always, after halting, dressed to the right by the gunner.

POSTS OF THE DETACHMENTS AT THEIR PIECES.

120. **In front.** The detachment is in line facing to the front, 2 yards from the end of the pole or the lead horses.

In rear. The centre of the detachment is 2 yards behind the muzzle, and facing to it.

On the right or left. The detachment is in line opposite the limber axletree, and 3 yards from it. In *horse artillery*, it is in line with and 3 yards from the leading horses. In all cases it faces to the front.

CHANGE OF POSTS OF DETACHMENTS AT THEIR PIECES.

121. **From front to rear.** The detachments being in line, in front of their pieces, to post them in rear, the instructor commands:

DETACHMENTS—REAR.

The gunner commands: *Cannoneers, rear FACE, MARCH*. At

the command MARCH, Nos. 1, 2, 3, and 4 oblique sufficiently to the left, and Nos. 5, 6, 7, and 8 to the right, move along the sides of their piece; re-unite as soon as they have passed it, and are halted at the proper distance, faced to the front, and aligned to the right by the gunner.

From rear to front. The instructor commands:

DETACHMENTS—FRONT.

The gunner repeats the command, and adds—MARCH. At this command, the cannoneers oblique; Nos. 1, 2, 3, and 4, to the left; Nos. 5, 6, 7, and 8 to the left; pass their piece, re-unite in front, and are halted and aligned to the right by the gunner.

From rear to right, (or left.) The instructor commands:

DETACHMENTS—RIGHT, (OR LEFT.)

The gunner commands *right (or left) oblique*, MARCH, and afterwards FORWARD, and HALT, in time to bring the detachment to its post on the right or left. He then aligns it to the right.

122. In horse artillery, to change from front to rear, the gunners command: *Left reverse*, MARCH; FORWARD: *Left reverse*, MARCH; HALT.

From rear to front. The gunners command: *Right oblique*, MARCH; FORWARD. *Left oblique*, MARCH; FORWARD; HALT.

From rear to right, (or left.) The gunners command: *Right (or left) oblique*, MARCH; FORWARD; HALT.

From right (or left) to rear. The gunners command: *Right (or left) reverse*, MARCH; FORWARD; *Right (or left) reverse*, MARCH; HALT.

If the piece is moving when the change of post is ordered, the gunner halts or slackens the pace until it passes, and then commands: *Left (or right) oblique*, MARCH; FORWARD.

The commands of the instructor are the same as in foot artillery. The movements are executed in the same manner when the detachments are dismounted.

TO POST THE CANNONEERS AT THE PIECES LIMBERED.

123. The detachment being formed in line in front or rear, on the right or left, the instructor commands :

CANNONEERS, TO YOUR POSTS.

From the front. The gunner faces the detachment to the right, and commands: *To your posts*, MARCH. At this command, the cannoneers, Nos. 1 and 2, turning to the right, and opening out, file to their posts; halt at their proper places, and face to the front.

From the rear, right or left. At the command CANNONEERS TO YOUR POSTS, the gunner, in each case, faces the detachment to the left, and marches the cannoneers by that flank to their posts.

MOVING THE PIECE BY HAND. PIECE LIMBERED.

124. **To the front.** The instructor commands :

1. FORWARD. 2. MARCH. 3. HALT.

At the first command, Nos. 6 and 7 seize the end of the pole with both hands, the gunner and No. 5, facing towards the pole, seize the splinter bar with one hand, and the pole with the other; Nos. 3 and 4 seize the spokes of the hind wheels with both hands, and Nos. 1 and 2 apply both hands at the head of the carriage. At the second command, all acting together, urge the piece forward until the command HALT is given, when all resume their posts.

125. **To the rear.** The instructor commands :

1. BACKWARD. 2. MARCH. 3. HALT.

At the first command, all face to the rear; Nos. 6 and 7 seize the end of the pole with both hands; No. 5 and the gunner seize the spokes of the limber, and Nos. 1, 2, 3, and 4 those of the hind wheels. At the command MARCH, all moving together, move the piece to the rear, Nos. 6 and 7 keeping it straight by the use of the pole. At the command HALT, all resume their posts.

UNLIMBERING, AND COMING INTO ACTION.

126. **To the front.** The instructor commands :

ACTION FRONT.

At this command, the gunner takes out the key, and, assisted by No. 5, raises the trail from the pintle, and then commands **DRIVE ON**, upon which Nos. 6 and 7 reverse the limber to the left, and proceed with it to the rear; again reverse to the left, and halt so that the limber shall cover the piece, with the end of the pole 6 yards from the end of the trail handspike. At the same time that the limber moves off, the piece is brought about in all respects as in limbering to the front, except that the gunner and No. 5, without lowering the trail, carry it about, each by means of the handle on his own side. Nos. 6 and 7, when necessary, assist at the trail, after placing the limber in position.

As soon as the piece is brought about, and the trail lowered, No. 4 takes out the handspike and passes it to the gunner, who fixes it in the trail. No. 1 takes out the sponge, No. 3 unkeying it, and No. 4 prepares his lanyard. All then resume their posts.

127. **To the right, (or left.)** The instructor commands :

ACTION RIGHT, (OR LEFT.)

The piece is unlimbered, and placed in the required direction, and the limber wheels to the left, (or right,) and takes its place in rear, by reversing to the left, (or right.)

128. **To the rear.** The instructor commands :

1. *Fire to the rear.* 2. **IN BATTERY.**

At the command **IN BATTERY**, the piece is unlimbered as before; the trail immediately lowered, and the gun prepared for action; the limber moves directly forward at the command **DRIVE ON**, from the gunner, and takes its place by coming to the left about.

SERVICE OF THE GUN WITH DIMINISHED NUMBERS.

129. The men should be frequently exercised in serving pieces with diminished numbers, that each may know the duties he has to perform in such cases.

Disabled men are replaced as soon as possible by the highest

numbers, or, if men are selected to replace them, the highest numbers will be reduced to fill the vacancies thus created. During action, Nos. 1 and 2 may occasionally change places and numbers, as the duties of No. 1 are very severe.

130. Service of the gun by two men. The gunner commands, points, serves the vent, and fires; No. 1 sponges, loads, and serves ammunition.

Three men. The gunner commands, points, serves the vent, and fires; No. 1 sponges; No. 2 loads, and serves ammunition.

Four men. The gunner commands and points; No. 1 sponges; No. 2 loads, and serves ammunition; No. 3 serves the vent, and fires.

Five men. The gunner commands and points; No. 1 sponges; No. 2 loads; No. 3 serves the vent, and fires; No. 4 serves ammunition.

Six men. The gunner commands and points; No. 1 sponges; No. 2 loads; No. 3 serves the vent, and fires; Nos. 4 and 5 serve ammunition.

Seven men. The gunner commands and points; No. 1 sponges; No. 2 loads; No. 3 serves the vent, and attends to the trail; No. 4 fires; No. 6 is at the limber, serves ammunition to No. 5, and occasionally changes with him.

Eight men. No. 7 assists No. 6; the other numbers as before

TABLE FOR THE EXERCISE WITH DIMINISHED NUMBERS.

Nos. retained.	Distribution of duties.							
	Gunner.	1	2	3	4	5	6	7
G. 1.....	G. 3,4	1,2,5
G. 1, 2.....	G. 3,4	1	2, 5
G. 1, 2, 3.....	G.	1	2, 5	3, 4
G. 1, 2, 3, 4.....	G.	1	2	3, 4	5
G. 1, 2, 3, 4, 5.....	G.	1	2	3, 4	6	5
G. 1, 2, 3, 4, 5, 6.....	G.	1	2	3	4	5	6
G. 1, 2, 3, 4, 5, 6, 7..	G.	1	2	3	4	5	6	7

SUPPLY OF AMMUNITION IN ACTION.

131. When it is likely that movements must take place on the field, or the firing is slow, and it can be done without inconvenience, ammunition will be served direct from the rear chest of the caisson, No. 8 performing the duties prescribed for No. 6 at the limber chest. At convenient moments, the ammunition served out by No. 6 will be replaced from the rear caisson chest. If the ammunition chest at the piece is exhausted, the limber is replaced by that of the caisson, and the empty chest exchanged for the centre one of the caisson.

As a rule, the limber chests, and especially that of the piece, will be kept full at the expense of the others, so that in case of a sudden movement on the field there shall always be a sufficient supply of ammunition at hand.

ARTICLE FOURTH.

MECHANICAL MANŒUVRES.

Nomenclature.

132. Before executing the mechanical manœuvres, the instructor should designate the parts of the piece and its carriage, and explain their uses.

THE GUN.

(PLATES 6 and 7.) The gun for field service is made of bronze.

The **bore** is the interior hollow cylinder which receives the charge. It includes all the part bored out, viz., the **cylinder**, the **chamber**, if there is one, and the curved surface connecting them. The **bottom of the bore** is a plain surface, perpendicular to the **axis**. Its diameter is somewhat less than that of the bore, and is united with the sides by a curved surface. The **muzzle** is the entrance of the bore.

The **breech** is the mass of solid metal between the bottom of the bore and the cascable. The **seat** for the hausse is behind the base of the breech.

The **cascable** is the projecting part which terminates the piece. It consists of the **knob**, the **neck**, and the **fillet**.

The **reinforce** is the thickest part of the body of the gun.

The **chase** is the conical part of the gun in front of the reinforce.

The **neck** is the smallest part of the piece in front of the astragal, or mouldings, at the termination of the chase.

The **swell of the muzzle** is the large part of the gun in front of the neck; it gives strength to the gun at its termination, and facilitates the pointings; the **muzzle sight** is screwed into it.

In field howitzers a **muzzle band** takes the place of the swell of the muzzle.

The **face** is the front plane terminating the piece.

The **trunnions** are the projecting cylinders at the sides of the gun, which support it on its carriage. Their axes are in one line, which is perpendicular to the axis of the bore, and in the same plane with it.

The **rimbases** are the short cylinders uniting the trunnions with the body of the gun. Their **ends**, or the **shoulders of the trunnions**, are in planes perpendicular to the axis of the trunnions.

The **vent** is a cylindrical hole, terminating near the bottom of the bore, through which fire is communicated to the charge. It is bored through a **vent piece** of wrought copper, which is screwed into the gun.

The **handles** in heavy field guns are used in the mechanical manœuvres. They are placed with their centres over the centre of gravity of the piece.

THE CARRIAGE.

(PLATES 8 and 9.) The **cheeks** are two pieces of wood between which the gun rests.

The **stock** is of squared wood, in two pieces, joined to the cheeks, and serving to connect the two parts of the carriage together. It is used in directing the piece, etc.

The **trail** is the curved part of the stock, which rests on the ground when the piece is in battery.

The **trunnion plates** are fastened on the cheeks to receive the trunnions.

The **cap squares** are pieces of iron placed over the trunnions to keep them in their plates. They are fastened by chains, pins, and keys.

The **elevating screw** serves to raise or lower the breech. It has a handle with four prongs.

The **lock chain** is placed on the side of the carriage. It serves to keep the wheel from turning.

The **trail handles** are placed on each side of the stock, and serve to raise it.

The **trail plate** is a piece of iron fastened at the trail, having a very stout ring, called the **trail lunette**, which receives the **pinle hook**.

The **pointing rings** (large and small) are on the trail; the large one turns. They receive the handspike.

The **prolonge hooks** are placed on the upper part of the stock. They serve to secure the prolonge when coiled.

THE LIMBER.

(PLATES 10 and 11.) The **limber** is the forward part of the carriage, and runs upon the two fore wheels.

The **axle body** is the wooden part in which the iron **axletree** is placed.

The **hounds** are pieces of wood connecting the body of the axle to the **splinter bar**, and upon which the ammunition chest rests.

The **fork** is a piece of wood between the **hounds**, and forms an opening in which the pole is placed.

The **splinter bar** serves for hitching the wheel horses, and has for this purpose four **trace hooks**. It is fastened on the **hounds** and **fork**.

The **pole straps** guide the pole. They are attached to the harness of the wheel horses, passing through sliding loops on the **breast straps**.

The **branches of the pole yoke** are attached by means of sliding rings to the collars of the wheel horses, and support the pole.

The **pinle hook**, on the hind part of the **limber axletree**, serves to unite the **limber** to the carriage, and has a **key**.

The **ammunition chest** serves to transport ammunition, and is placed on the **limber**.

THE CAISSON.

(PLATES 12 and 13.) It consists of a frame, mounted on wheels,

for the transport of two ammunition chests, a spare wheel, and other spare parts, tools, etc. Its limber is similar to that of the piece. In case of necessity, cannoneers may be transported on the chests.

The **stock** has an iron lunette on the front end; at the rear end it is let in 4 inches for its whole width into the front of the axle body.

The **axle body** is notched to receive the middle rail, and has tenons to fit into notches in the side rails.

The **middle** and two **side rails**, and one **cross bar**, complete the wooden parts of the frame.

The **middle assembling bar** (iron) has two **ears** in the middle, to serve as stay plates for the ammunition chests, and a **slat** for the axe blade on the right of the middle rail.

The **rear assembling bar** supports the spare wheel axle. It has a **slat** on the left of the middle rail for carrying a pick-axe.

The **spare wheel axle** consists of a **body** and **two ribs**; it has a **chain** and **toggle** to secure the wheel. There are **two stays** for the axle, the bolt hole in the head of one of them is square, in the other round.

The **carriage hook** is intended to take a carriage which may have lost its limber.

The **bolster** for the front foot board is fastened on the middle of the cross bar. The **front foot board** is fastened to the rails and cross bar; the **rear foot board** to the rails only.

The **key plate for spare pole** is fastened on the under side of the lunette. The **key** is attached to the left side of the stock by a chain and eye pin, screwed into the left side of the stock. The **spare pole ring** is held by the axle strap.

The **spare handspike ring**, **key plate**, and **key**, are on the right side of the middle rail.

One **key plate** and **key**, for the shovel handle, are fastened on the inside of the right side rail.

The **lock chain bridle** is fastened under the front end of the left side rail; it holds the large ring of the lock chain. The **lock chain hook** is fastened on the outside of the left side rail.

Two staples for tool handles are driven into the top of the axle body, in front of the iron axletree: one for the shovel handle, near the right side rail; the other for the handle of the pick-axe, on the left of the middle rail.

The different parts are secured to each other by nails, rivets, bolts, nuts, and screws, etc.

All parts of the carriages should be examined closely by the proper mechanics, at least once a week when in garrison, and daily in the field, the defective parts removed or repaired, and the fastenings kept secure and the nuts screwed tight.

133. The manœuvres are prescribed for the 6-pounder and heavy 12-pounder batteries now in service. For batteries of light 12-pounders, the methods laid down for the 6-pounder batteries will, in general, apply. *Care must be taken that the men do not overstrain themselves.* When practicable, the full number of men prescribed for each manœuvre must always be employed.

CHANGING AMMUNITION CHESTS.

134. In service, when the limber chest of the piece is emptied, the piece and caisson exchange limbers; No. 8, assisted by No. 7, unlimbers and limbers up the caisson, and the middle chest is exchanged with the empty one on the limber as soon as practicable.

To change the ammunition chests, the instructor commands:

1. *Prepare to change the ammunition chest.*
2. **CHANGE THE CHEST.**

At the first command, Nos. 5 and 6 unkey the empty chest, each on his own side, and, taking hold of the handles, place it upon the ground, on the left of the caisson. Nos. 7 and 8 unkey the middle chest at the same time.

At the command **CHANGE THE CHEST**, Nos. 5, 6, 7, and 8, seizing the middle chest by the handles, lift it on the foot board, and, turning it end for end there, shift the chest along the stock to the limber, taking great care not to cut the bottom on the nuts, and put it in place; Nos. 5 and 6 resume their posts immediately;

Nos. 7 and 8 key the chest, replace the empty chest, key it, and resume their posts.

CHANGING WHEELS.

135. **6-pdr. Gun and 12-pdr. Howitzer.** The piece being unlimbered, to change the right wheel, the instructor commands:

1. *Prepare to change the right wheel.*
2. **CHANGE THE WHEEL.**

At the first command, Nos. 5, 6, and 7 dismount the spare wheel; No. 5 brings it near, and parallel to the disabled one, leaving room for the latter to be taken off. The gunner passes one end of his handspike to No. 1, placing it under the axletree close to the shoulder. The gunner and No. 1, placing themselves between the handspike and piece, and facing the wheel, take hold of the handspike near the axle; Nos. 4 and 6 take hold of the ends of the handspike; No. 6 assisting the gunner.

At the command **CHANGE THE WHEEL**, the carriage is raised; Nos. 2 and 3 take off the disabled wheel; No. 2 runs it to the rear, and Nos. 3 and 5 put on the spare wheel, No. 3 taking hold of it in the rear. Nos. 3 and 4 attend to the linchpins and washers on their respective sides.

To change the left wheel, the gunner and No. 2, assisted by No. 6 and No. 3 respectively, man the handspike; Nos. 1 and 4 take off the wheel; Nos. 5, 6, and 7 dismount the spare wheel; No. 5 brings it up, and Nos. 4 and 5 put it on; No. 1 runs the disabled wheel to the rear.

The men at the handspike must raise the end of the axletree sufficiently high to throw the weight on the other wheel, and those who take off the wheel must also lift it, and not increase the weight by allowing it to slide along the axletree.

12-pdr. Gun and 24-pdr. Howitzer. One end of a prolonge is fastened to the axletree near the disabled wheel, the other end being passed over the opposite wheel and manned by four men from another piece. A spare pole, manned by Nos. 1, 2, 3, 4, 5, and 6, must be substituted for the handspike under the axletree. The gunner and No. 7 take off and put on the wheels. When a

spare pole cannot be obtained, the carriage may be raised by means of the handspikes; No. 2 places one in the muzzle, and No. 1 crosses the other under it; No. 3 assists at the handspike in the muzzle, and Nos. 4, 5, and 6 at the other, No. 4 on the outside. The four men from the other piece take hold of the cheeks on the side to be raised. All acting together, raise the carriage at the command **CHANGE THE WHEEL**. The prolonge is not required. The manœuvre would be made easier by digging a trench 5 or 6 inches deep for the other wheel.

When a wheel at the piece is disabled in action, it may be replaced by one from its limber. The disabled wheel, if not quite unserviceable, may be used at the limber until it can be conveniently changed; but, if entirely unserviceable, one must be obtained from the caisson as soon as it is possible to bring it up.

In taking off a limber wheel the horses are taken out; No. 6 removes the linchpin and washer; Nos. 3 and 4, assisted by Nos. 7 and 8, raise the limber, No. 3 in front, and No. 4 in rear of the axletree; Nos. 5 and 6 take off the wheel, and No. 5 runs it forward. The axletree is lowered gently to the ground.

The wheel of the limber is replaced by Nos. 1, 2, 5, and 6, after the wheel of the piece is on, Nos. 1 and 2 raising the limber, assisted by Nos. 7 and 8.

When a wheel has been disabled in the carriage of either piece or caisson, and cannot be replaced by another, a spar 10 or 12 feet long may be placed under the axletree, with one end resting on the ground and the other secured to the carriage by lashing, so that the axletree may be supported in its proper position without the wheel. The part of the carriage thus supported should be relieved of as much weight as possible.

When a wheel has been so disabled that it cannot turn, a shoe of wood may be made and placed under it. A piece of spar about 3 feet long and 9 inches in diameter, with a groove in one side to receive the felloe, will answer for this purpose. The end in front is given the proper form, and the lock chain fastened to it. In this case also, the carriage should be relieved from as much weight as possible.

DISMOUNTING PIECES.

136. 6-pdr. Gun and 12-pdr. Howitzer. The piece being unlimbered, the instructor commands :

1. *Prepare to dismount the piece.*

2. **DISMOUNT THE PIECE.**

At the first command, Nos. 1, 2, 3, and 4 remove the implements and place them on the ground, outside of their respective wheels, the bucket with a sponge and handspike on the right, and the worm with a sponge and handspike on the left. Nos. 1 and 2 then press upon the muzzle, and Nos. 3 and 4, after removing the cap squares, station themselves at the end of the cheeks, and, with one hand on the wheel and the other on the knob of the cascable, prepare to raise the breech. The gunner, first taking out the handspike if in the trail, and passing it to No. 4, raises the elevating screw to its greatest height, and then seizes the left trail handle; No. 5 seizes the right, and Nos. 6 and 7, after scotching the wheels, go to the trail to assist in raising it.

At the second command, Nos. 1 and 2 bear down upon the muzzle, the gunner and Nos. 5, 6, and 7 raise the trail until the muzzle rests upon the ground, No. 5, with the howitzer, holding the lock chain to prevent the trail from falling over to the front. Nos. 3 and 4 push against the cascable to raise the breech, and, when the piece is vertical, run round to assist Nos. 1 and 2 to keep it in that position. The trail is then lowered, the carriage run back, and the piece placed on the ground, vent upwards. The cannoneers then replace the implements, Nos. 3 and 4 securing the cap squares.

12-pdr. Gun and 24-pdr. Howitzer. These are dismounted in the same manner, except that Nos. 1 and 2 make a hole in the ground under the head of the carriage, one foot deep for the 12-pdr. and eight inches for the howitzer, to receive the muzzle, and they are assisted by two additional men in pressing upon the muzzle and in steadying the piece.

By attaching the middle of a rope with an artificer's knot to the knob of the cascable, and hauling upon the ends of it, the

piece may be more securely steadied. Nos. 3 and 4 attach the rope, pass the ends over to Nos. 1 and 2, and then go round to assist them in hauling upon them. Four additional men from another piece also assist. When the trail is raised so as to let the muzzle touch the bottom of the hole, the men haul upon the rope and disengage the gun, Nos. 1, 2, 3, and 4 coming up hand over hand to steady it.

A rope may also be used in dismounting the 6-pdr. gun and 12-pdr. howitzer. Nos. 1 and 2 man the rope, and Nos. 3 and 4 steady the wheels. No additional men are required.

MOUNTING PIECES.

137. **6-pdr. Gun and 12-pdr. Howitzer.** The piece being on the ground, vent upwards, the instructor commands:

1. *Prepare to mount the piece.*
2. **MOUNT THE PIECE.**

At the first command, the implements are removed as in dismounting, except that the handspikes, instead of being placed on the ground, are passed by Nos. 3 and 4, respectively, to the gunner and No. 2; Nos. 3 and 4 take off the cap squares; No. 2 inserts his handspike in the bore, and, assisted by No. 1, raises the chase, so that the gunner may put his handspike under the piece a little in rear of the trunnions. This being done, No. 2 withdraws his handspike from the bore, and places it under the knob of the cascable. Nos. 1, 3, and 4 assist at the handspike of No. 2, and Nos. 5, 6, and 7 at that of the gunner, Nos. 1, 2, 5, and the gunner being at the ends. The gunner then commands: **HEAVE**, upon which the men, acting together, raise the piece upright, and Nos. 1, 2, 3, and 4 steady it in that position. The gunner and No. 5 go to the trail, and, assisted by Nos. 6 and 7 at the wheels, run the carriage forward within a foot of the piece. Nos. 6 and 7 scotch the wheels, if necessary, and then go to the trail to assist the gunner and No. 5 in raising it.

At the second command, the trail is raised, No. 5, with the howitzer, holding the lock chain to prevent the trail from falling over to the front; Nos. 1 and 2 push gently against the piece

and place the trunnions in their plates. The trail is then lowered carefully to the ground, the wheels unscotched, and the implements replaced, Nos. 3 and 4 securing the cap squares. When necessary, the duties of Nos. 6 and 7 can be performed by Nos. 3 and 4.

The piece may be also easily raised by means of a rope, without the use of handspikes. The gunner fixes the middle of the rope to the knob of the cascable by an artificer's knot, and Nos. 1, 2, 3, 4, 5, and 6 man the ends, Nos. 1 and 2 being nearest the cascable. By hauling upon the rope the piece is raised. It is then mounted as before.

12-pdr. Gun and 24-pdr. Howitzer. These are mounted by means of handspikes in the same manner as the 6-pdr. gun and 12-pdr. howitzer, except that Nos. 1 and 2 make a hole in the ground, one foot deep for the 12-pdr. and eight inches for the howitzer, to receive the muzzle, and two additional men act at the handles.

It will facilitate the raising of the piece, and give greater security, to fasten the handspike to the cascable by means of a rope, and also to fasten, by an artificer's knot, the middle of a prolonge or picket rope to the cascable, and man the ends of it by men from another piece. In this case, when the piece is raised as high as the men's hips, the gunner and Nos. 5, 6, and 7 quit the handspike, two at a time, and assist at the prolonge. In placing the piece on the carriage, Nos. 3 and 4 carry the prolonge to the rear, and assist by hauling upon it. When the piece does not fall exactly into the trunnion plates, the prolonge is passed round under the cheeks to secure the breech to the carriage; the trail being then lowered, the trunnions slide into their beds.

CARRYING PIECES.

138. The piece being on the ground, vent upwards, the instructor commands:

1. *Prepare to carry the piece.*
2. FORWARD.
3. MARCH.

At the first command, Nos. 6 and 7 back the limber over the breech until the pintle hook is just above the trunnions; No. 2 inserts a handspike in the bore to raise the piece, and Nos. 1, 3, and 4 stand near to assist him; the gunner, assisted by No. 5, passes the ring of the prolonge through the handles, and after making a turn with the prolonge round the pintle hook, passes the ring through the handles again and puts it on the pintle. If there are no handles, the prolonge should be passed round the piece, in front and rear of the trunnions, the piece being raised for that purpose. Nos. 6 and 7 then raise the pole, and Nos. 1, 2, 3, and 4 the piece, if not already raised; the gunner tightens the prolonge, pulling on the free end, which he passes over the pintle hook, and under the limber to No. 5, who receives it at the splinter bar and makes a turn with it round the fork. The pole is then lowered, and Nos. 1 and 2 press upon the muzzle to raise the breech. The gunner, assisted by No. 5, lashes the knob of the cascable to the splinter bar, fastening the end of the prolonge by half hitches. The piece when slung should be horizontal.

At the second command, the cannoneers prepare to move the limber forward, as in No. 115.

At the command **MARCH**, they move the limber to the front.

When the horses are hitched in, they should be taken out to enable the men to sling the piece.

A limber, in addition to carrying the piece, may also carry a disabled carriage when it is taken apart and lashed upon it; but as the weight when so distributed is too great to be carried far, the carriage should be placed upon the caisson as soon as it can be done.

When a limber is disabled, the trail of the carriage or caisson is attached to the rear of another carriage.

DISMOUNTING CARRIAGES.

139. Carriage of the 6-pdr. Gun and 12pdr. Howitzer.
The piece being dismounted and implements taken off, as already described, the instructor commands:

1. *Prepare to dismount the carriage.*

2. DISMOUNT THE CARRIAGE.

At the first command, Nos. 3 and 4 remove the linchpins and washers, and Nos. 1, 2, 3, and 4 step inside the wheels and take hold of the carriage.

At the second command, Nos. 1, 2, 3, and 4 lift the carriage, Nos. 5 and 7 take off the right wheel, and Nos. 6 and 8 the left, Nos. 5 and 6 taking hold in front, and 7 and 8 in rear.

If necessary, each wheel may be taken off by one man.

The carriage of the 12-pdr. gun and 24-pdr. howitzer is dismounted in the same manner, with the addition of two or four men to assist in lifting the carriage.

Limbers. The limbers are dismounted in the same manner as the carriages; the different numbers taking hold in the same relative positions and performing the same duties.

MOUNTING CARRIAGES.

140. The method of mounting carriages and limbers corresponds to that of dismounting them.

RIGHTING CARRIAGES THAT HAVE BEEN OVERTURNED.

141. When a carriage has been overturned it is better, if time permits, to disengage the piece, right the carriage, and then mount the piece again in the manner already described. The piece may be easily disengaged by allowing the breech to rest upon the ground, or a block of wood, raising the muzzle by means of a handspike while the cap squares are taken off.

The carriage may be righted, however, without disengaging the piece, by the following modes:

1st. Detach the limber, secure the cap squares, and lash the knob of the cascable to the stock. Place the middle of a rope over the nave of one wheel, pass the ends of it downward between the lower spokes of that wheel, then under the carriage, through the corresponding spokes of the other wheel, and then upwards over the wheel, and across the top of the carriage, to the side

where it was first attached. The ends of the rope and the wheel to be raised are then manned, and the carriage drawn over to its upright position. During this operation two men are required to steady the trail.

If necessary, the ends of the rope may be fastened to the limber, and horses used to assist in righting the carriage. Great care must be taken to stop the horses in time, and to prevent them from making any more effort than is absolutely necessary. If the wheel horses are sufficient, the leaders may be unhitched.

2d. Detach the limber, attach two prolonges, or the middle of a picket rope, to the trail, chock the wheels, and dig an oblong hole under the muzzle, about two and a half feet deep. Then pass one of the prolonges, or one end of the picket rope, over the carriage to the front, and, manning both, raise the trail and pass it over the axletree to the ground on the opposite side.

Light carriages may be righted by hand without attaching a rope.

SPIKING AND UNSPIKING CANNON, AND RENDERING THEM UNSERVICEABLE.

142. **To spike a piece, or to render it unserviceable.** Drive into the vent a jagged and hardened steel spike with a soft point, or a nail without a head; break it off flush with the outer surface and clinch the point inside by means of the rammer. Wedge a shot in the bottom of the bore by wrapping it with felt, or by means of iron wedges, using the rammer or a bar of iron to drive them in; a wooden wedge would be easily burnt by means of a charcoal fire lighted with the aid of a bellows. Cause shells to burst in the bore of brass guns, or fire broken shot from them with high charges. Fill a piece with sand over the charge to burst it. Fire a piece against another, muzzle to muzzle, or the muzzle of one to the chase of the other. Light a fire under the chase of a brass gun, and strike on it with a sledge to bend it. Break off the trunnions of iron guns; or burst them by firing them with heavy charges and full of shot, at a high elevation.

When guns are to be spiked temporarily, and are likely to be

retaken, a **spring spike** is used, having a shoulder to prevent its being too easily extracted.

To unspike a piece. If the spike is not screwed in or clinched, and the bore is not impeded, put in a charge of powder of one-third the weight of the shot, and ram junk wads over it with a handspike, laying on the bottom of the bore a strip of wood with a groove on the under side containing a strand of quick match, by which fire is communicated to the charge. In a brass gun, take out some of the metal at the upper orifice of the vent, and pour sulphuric acid into the groove for some hours before firing. If this method, several times repeated, is not successful, unscrew the vent piece, if it be a brass gun, and if an iron one, drill out the spike, or drill a new vent.

To drive out a shot wedged in the bore. Unscrew the vent piece, if there be one, and drive in wedges so as to start the shot forward, then ram it back again in order to seize the wedge with a hook; or pour in powder and fire it, after replacing the vent piece. In the last resort, bore a hole in the bottom of the breech, drive out the shot, and stop the hole with a screw.

Field 6-Pounder Gun. (Bronze.)

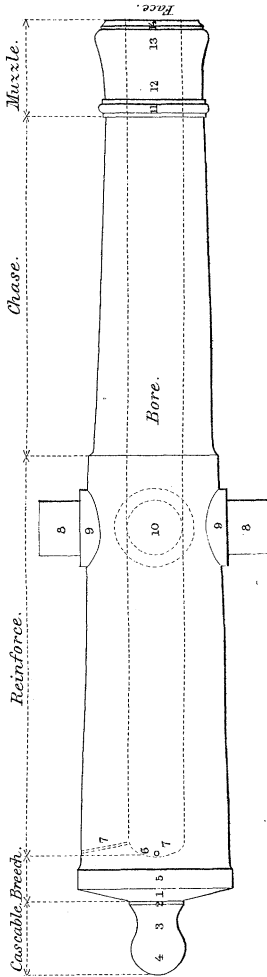

- | | | | | | | |
|----------|---|--------------------|--|--|--------|----------------------------------|
| Cascable | } | 1. Base of breech. | } | 6. Bottom of the bore. | } | 11. Astragal and Fillets. |
| | | 2. Fillet. | | 7. Horizontal and vertical projections of vent and vent-piece. | | 12. Neck. |
| | | 3. Neck. | Reinforce | 8. Horizontal projection of trunnions. | Muzzle | 13. Swell of Muzzle. |
| | | 4. Knob. | | 9. Do. do. Rimbases. | | 14. Muzzle mouldings (lip) Face. |
| | | 5. Base ring. | 10. Vertical do. Trunnions & rimbases. | | | |

Field 24 Pounder Howitzer (Bronze)

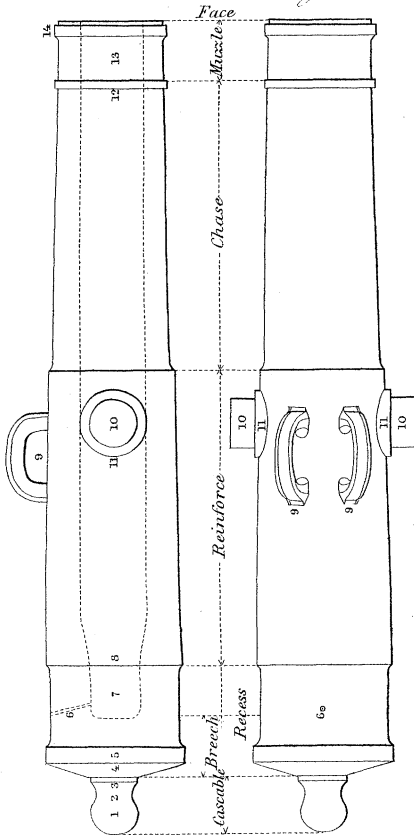

{ 1. Knob.
 2. Neck.
 3. Fillet.
 Cascable

- 4. Base of Breech.
- 5. Base ring.
- 6. Vent and vent piece.
- 7. Chamber.
- 8. Slope or conical junction of the cylinder and chamber.
- 9. Handles.
- 10. Trunnions.
- 11. Rimbases.
- 12. Chase ring.
- 13. Neck.
- 14. Muzzle band and muzzle fillet.

Bore - Chamber, Slope, and Cylinder.

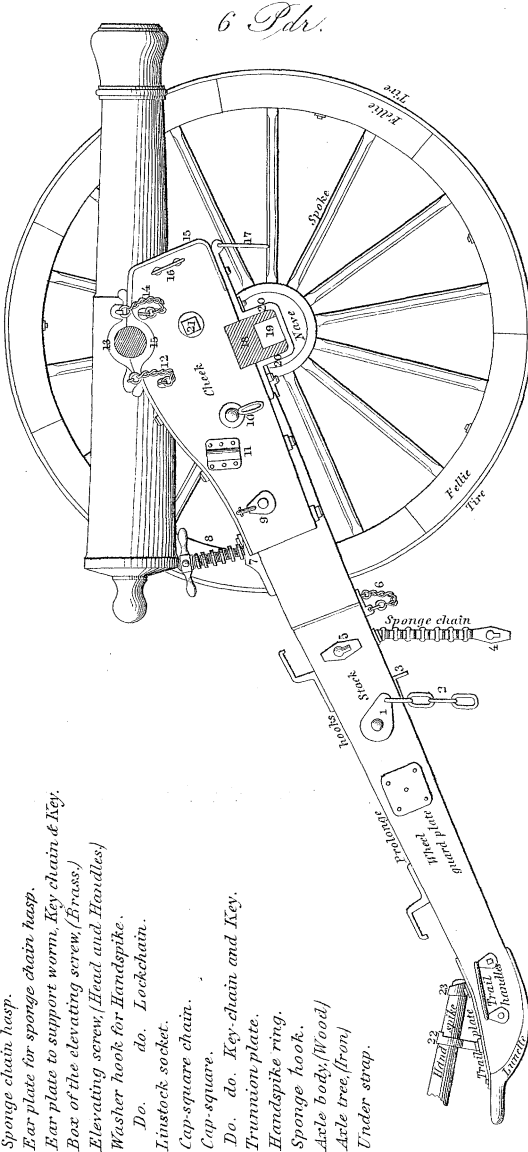

1. Lock chain bolt and eye plate.
2. Part of the lock chain.
3. Sponge and rammer stop.
4. Sponge chain hasp.
5. Ear-plate for sponge chain hasp.
6. Ear-plate to support worm, Key chain & Key.
7. Box of the elevating screw, (Brass.)
8. Elevating screw, (Head and Handles)
9. Washer hook for Handspike.
10. Do. do. Lockchain.
11. Instock socket.
12. Cap-square chain.
13. Cap-square.
14. Do. do. Key-chain and Key.
15. Trunnion plate.
16. Handspike ring.
17. Sponge hook.
18. Axle body, (Wood)
19. Axle tree, (Iron)
20. Under strap.

9. } Are also the extremities
 10. } of the assembling bolts.
 22. Large pointing ring.
 23. Small do. do.

Head, groove, trail and,
 Stock } the rounding of the trail.

Projection of 6 Pdr. Carriage on a plane parallel to the under side of the stock. (mounted)

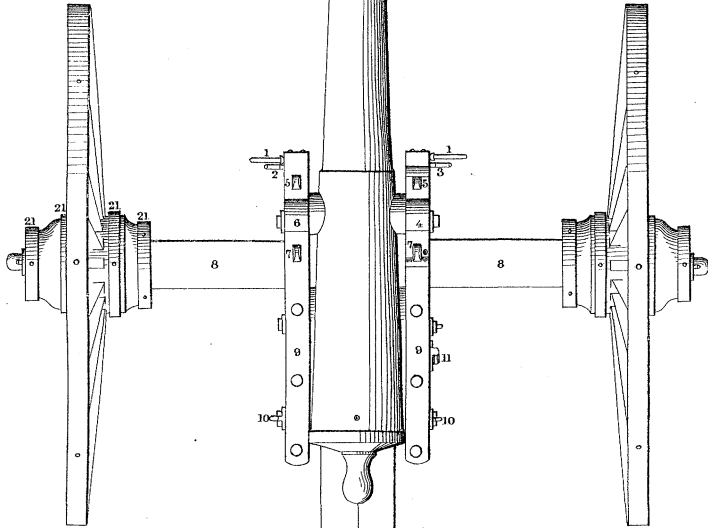

- 1. Hand spike rings.
- 2. Sponge and worm hook.
- 3. Right sponge hook.
- 4. Cap square.
- 5. Head of Key bolts.
- 6. Trunnion (cap square removed.)
- 7. Head of chin bolts.
- 8. Axle body.
- 9. Trunnion plates.
- 10. Washer hook for handspikes.
- 11. Linstock socket.
- 12. Eye plates and hasps to support sponge.
- 13. Lock chain, Eye plate and bolt.
- 14. Prolonge hooks and prolonge.
- 15. Wheel guard plates.
- 16. Trail handles.
- 17. Small pointing ring.
- 18. Large. " "
- 19. Trail plate.
- 20. Lunette. 21. Nave bands.

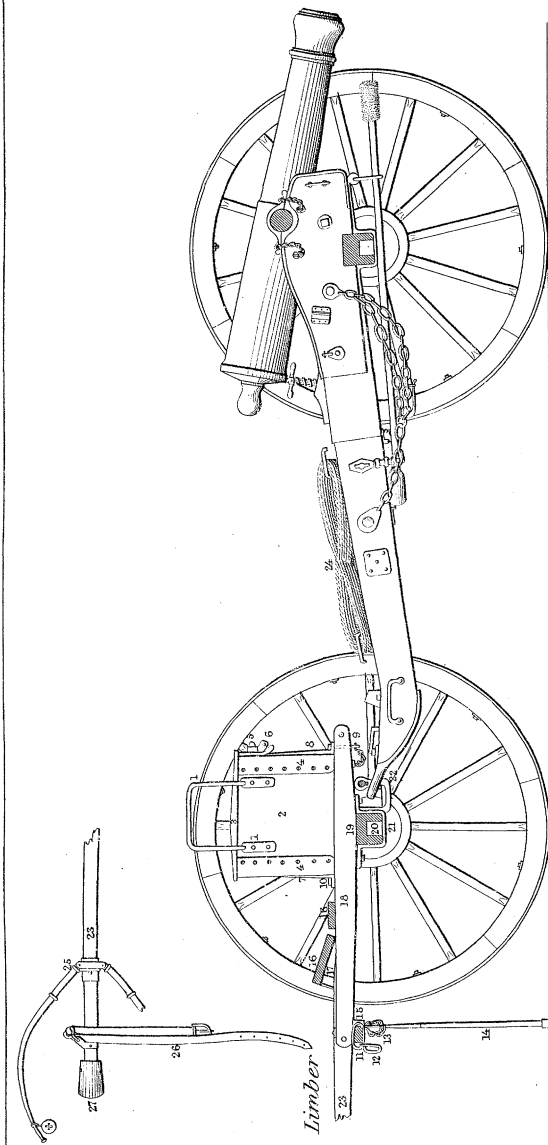

- 1. Handles.
- 2. Ammunition Chest.
- 3. Cover (or lid.)
- 4. Corner plates.
- 5. Turnbuckle.
- 6. Hoop.
- 7. Back strap.
- 8. Front do.
- 9. Stay pins. Keys, &c.
- 10. Stay for Ammunition Chest.
- 11. End bands of splinter-bar.
- 12. Trace Hooks.
- 13. Pole prop chain.
- 14. Pole prop (Socket & ferrule).
- 15. Splinter bar.
- 16. Foot boards.
- 17. Foot board brackets.
- 18. Hounds.
- 19. Axle body.
- 20. Axle tree.
- 21. Under strap.
- 22. Fiddle hook.
- 23. Pole.
- 24. Prolonge.
- 25. Pole yoke.
- 26. Pole strap.
- 27. Pole pad.

The shoulder washers, Linch pins, Linch washers, and Wheels, are the same as for the Gun carriage.

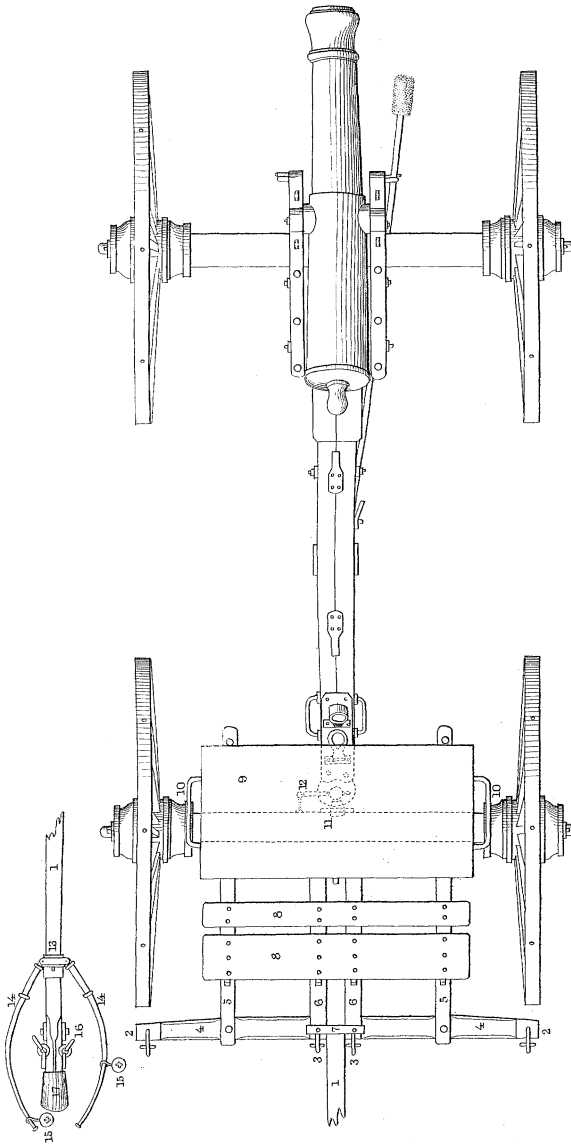

- 1. Pole.
- 2. End bands of splinter bar and trace hooks.
- 3. Middle bands of splinter bar and trace hooks.
- 4. Splinter bar.
- 5. Hounds.
- 6. Fork.
- 7. Fork strap.
- 8. Foot boards.
- 9. Ammunition chest.
- 10. Handles of Ammⁿ. chest.
- 11. Finitle hook.
- 12. Finitle hook Key.
- 13. Muff and collar of Pole yoke.
- 14. Branches of do.
- 15. Sliding rings.
- 16. Pole strap iron.
- 17. Pole pad.

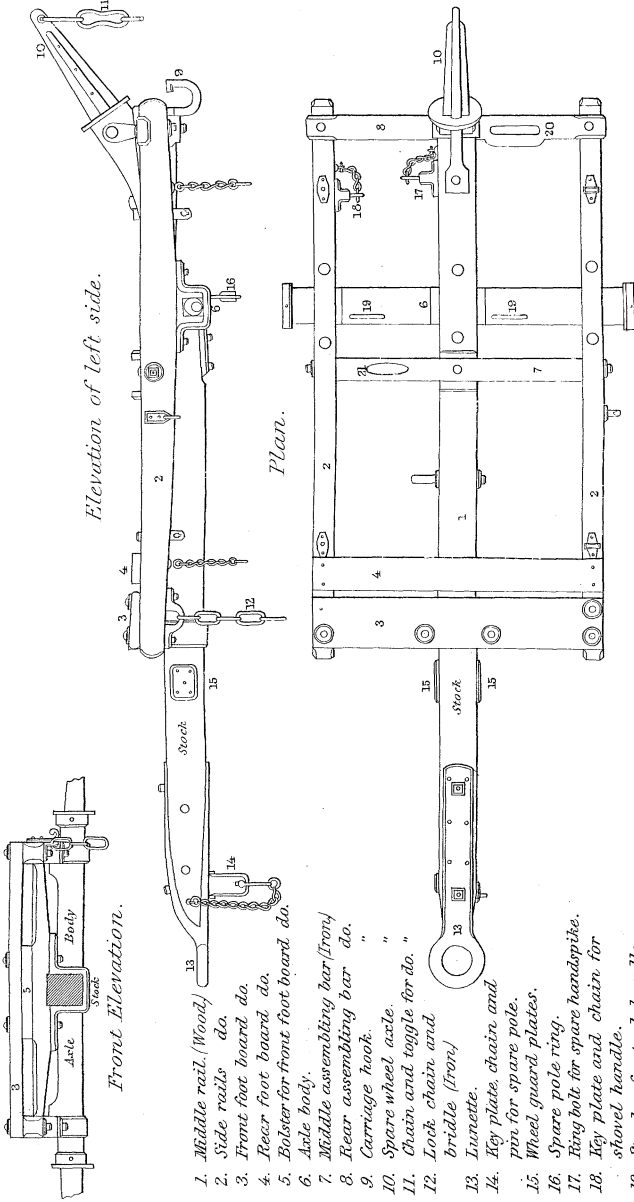

Elevation of left side.

Plan.

Front Elevation.

1. Middle rail. (Wood.)
2. Side rails do.
3. Front foot board do.
4. Rear foot board do.
5. Bolster-for front foot board do.
6. Axle body.
7. Middle assembling bar (Iron)
8. Rear assembling bar do.
9. Carriage hook.
10. Spare wheel axle.
11. Chain and toggle for do. "
12. Lock chain and
bridle (Iron)
13. Lunette.
14. Key plate, chain and
pin for spare pole.
15. Wheel guard plates.
16. Spare pole ring.
17. Ring bolt for spare handspike.
18. Key plate and chain for
shovel handle.
19. Staples for tool handle.
20. Slot for Fibbawc.
21. " " " "

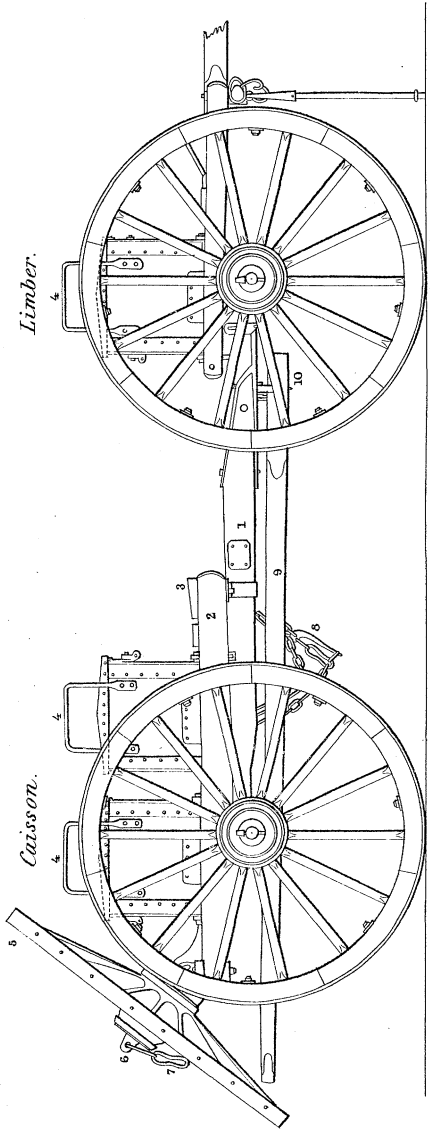

Caisson.

Limber.

- 1. Stock.
- 2. Side rail.
- 3. Foot board.
- 4. Ammunition Chest.
- 5. Spare wheel.
- 6. Axle for spare wheel.
- 7. Chain and toggle.
- 8. Lock chain.
- 9. Spare pole.
- 10. Spare pole key.

Battery Wagon.

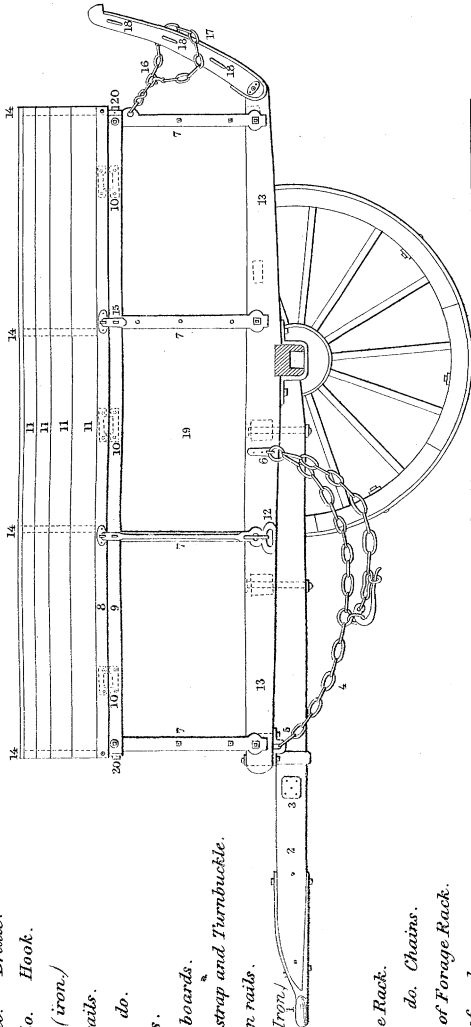

- 1. Lunette.
- 2. Stock.
- 3. Guard plate.
- 4. Lock chain.
- 5. do. Bridle.
- 6. do. Hook.
- 7. Studs (iron.)
- 8. Side rails.
- 9. Upper do.
- 10. Hinges.
- 11. Cover boards.
- 12. Cover strap and Turnbuckle.
- 13. Bottom rails.
- 14. Bows (Iron.)
- 15. Hasp.
- Forage Rack.
- 16. do. do. Chains.
- 17. Sides of Forage Rack.
- 18. Bars of do.
- 19. Side Boards.
- 20. Side Stays.

Battery Wagon.

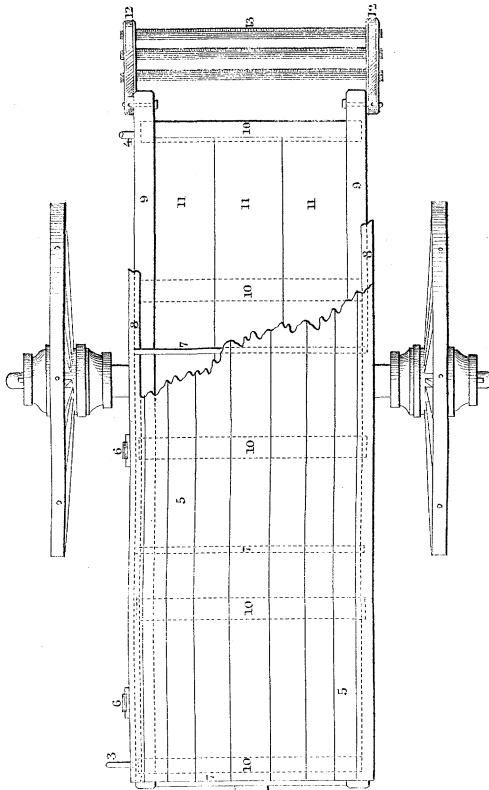

- 1 Lunette.
- 2 Stock.
- 3 Spare stock stirrup. } To carry a spare
- 4 do. do. Hook. } iron bound stock.
- 5 Cover boards.
- 6 Hinges.
- 7 Bows.
- 8 Side rails.
- 9 Bottom rails.
- 10 Cross bars.
- 11 Bottom boards.
- 12 Sides of Forage rack.
- 13 Bars of do. do.

Wheels same as those for gun carriage.

Travelling Forge.

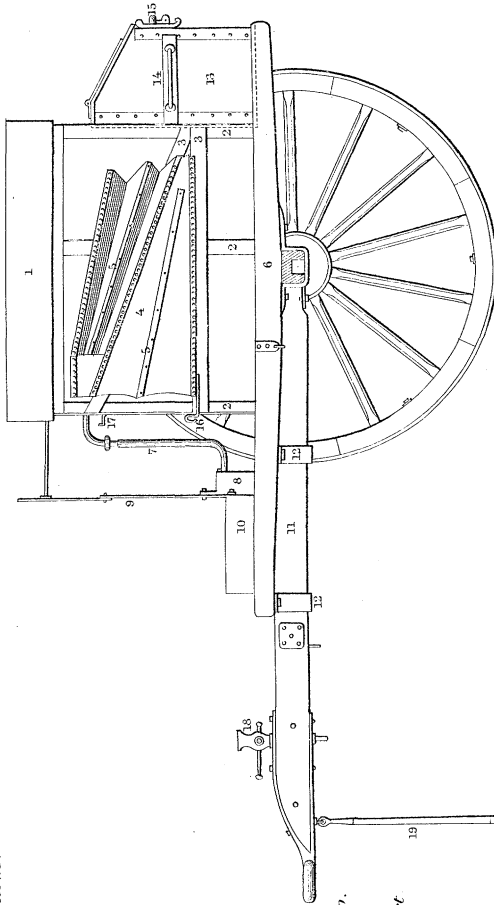

- 1 Roof of the bellows house.
- 2 Studs.
- 3 Girders to support bellows.
- 4 Bellows.
- 5 Ribs of do.
- 6 Side rail.
- 7 Windpipe.
- 8 Air back.
- 9 Back of fire place.
- 10 Fire place.
- 11 Stock.
- 12 Stock stirrups.
- 13 Coal box.
- 14 Handles.
- 15 Turnbuckle and Hasp.
- 16 Bellows Hook.
- 17 Poleman, and support for Bellows pole.
- 18 Fice.
- 19 Prop.

Travelling Forge.

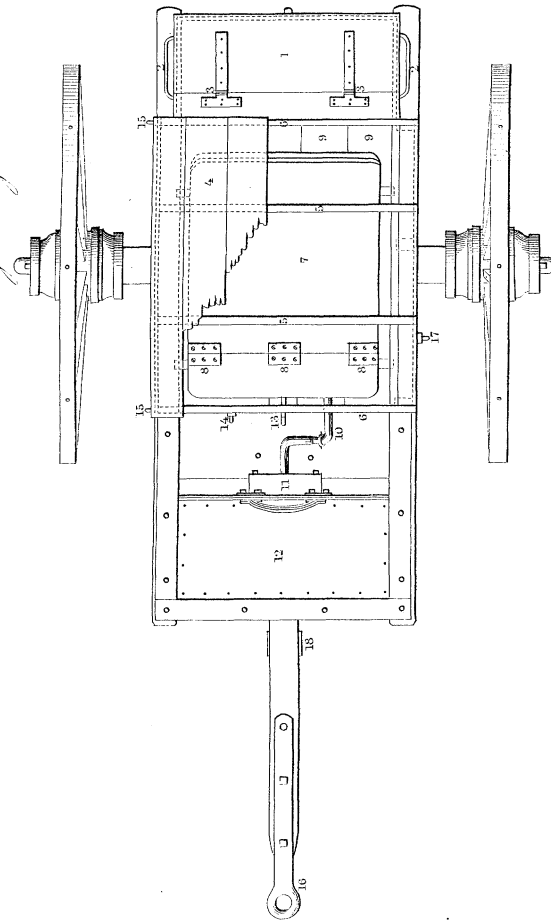

- 1 Lid of the coal box.
- 2 Handles of do.
- 3 Hinges of do.
- 4 Roof boards.
- 5 Dows.
- 6 End boards.
- 7 Bellows.
- 8 Hinges.
- 9 Bottom boards.
- 10 Windpipe.
- 11 Air back.
- 12 Fire place.
- 13 Bellows hook.
- 14 Filtrant.
- 15 Hook and staple for carrying bellows pole.
- 16 Lunette.
- 17 Lock chain hook.
- 18 Wheel guard plates.

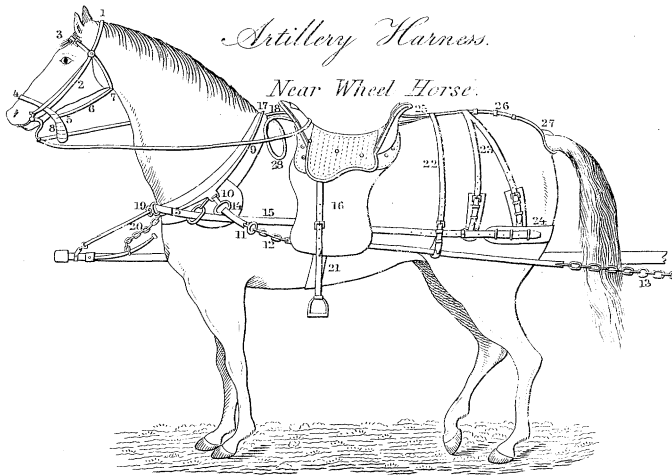

Artillery Harness.

Near Wheel Horse.

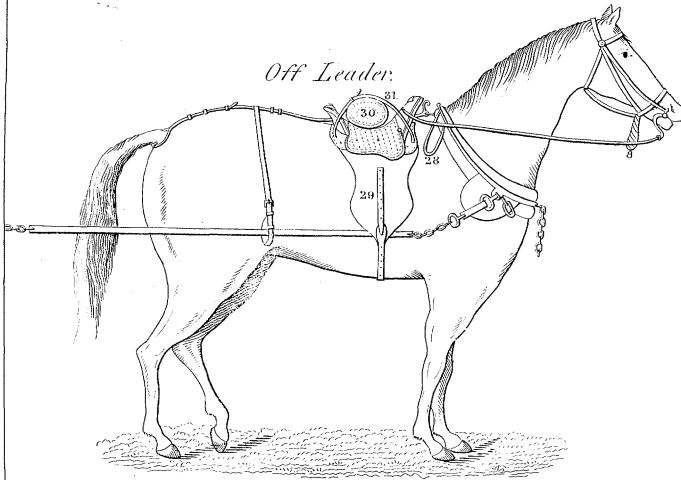

Off Leader.

Halter.

- 1 Crown piece.
- 2 Cheek strap.
- 3 Brow band.
- 4 Nose band.
- 5 Chin strap.
- 6 Throat strap.
- 7 Throat lash.
- 8 Hitching strap.

Bridle.

- Crown piece.
- Cheek strap.
- Brow band.
- Throat lash.
- Bit.
- Reins.

- Bit, curb (consisting of bar with a portmouth,) cheek pieces, and curb chain.)
- 9 Collar and Hames, with joint loops for trace tugs.
- 10 Trace tugs and safe.
- 11 Trace hook.
- 12 Trace.
- 13 Trace chain.
- 14 Safe.
- 15 Breast strap.
- 16 Saddle.
- 17 Hame strap.
- 18 Collar strap.
- 19 Sliding loop.
- 20 Chain and toggle.
- 21 Girth.
- 22 Loin strap.
- 23 Hip strap.
- 24 Breech strap.

(Crupper. 25 Back strap. 26 The body. 27 The dock.)

28. Trussing strap. 29 Valise saddle. 30 Valise. 31 Valise strap.

ARTICLE FIFTH.

THE CANNONEER MOUNTED.

General Remarks.

143. The object of this part is to instruct the cannoneer in the management of his horse at all gaits, and will be best attained by a gradual and constant application of the principles of the drill.

All the cannoneers of mounted batteries, as well as of horse artillery, should be thoroughly instructed in this part, as it is an indispensable preparation for the duties of a non-commissioned officer as well as for those of a driver.

144. It should be carefully impressed upon the men that the horse may be made gentle and obedient by patience, kindness, and fearlessness; that punishment is only to be resorted to when it cannot be avoided, and then only administered immediately after the commission of the offence; and that nothing should ever be done to the horse in anger.

Restlessness and impatience frequently arise from exuberance of spirits or playfulness. When restless, the horse should be held until he becomes calm; when submissive after punishment, he should be treated kindly. The cannoneers should endeavor to inspire him with confidence, and he should be gradually accustomed to warlike sounds—firing, beating of drums, etc.

The most quiet and best instructed horses will be chosen for the first lessons to recruits.

145. All mounted exercises should be commenced and ended at a walk. Horses cannot be taken with impunity from a state of rest in the stable and be at once subjected to the severe and rapid exercises required in the drills and battery manœuvres. It is almost equally injurious to place them, exhausted and heated

after great exertions, in a stable; especially in cold weather or where the stables are liable to have currents of air passing through them.

ELEMENTARY INSTRUCTION.

146. This should be carefully imparted, if practicable, to the men singly. Under no circumstances should more than four recruits be assigned to one instructor at the same time. They will then be placed in one rank, three yards apart.

The horses are taken in the stables or at the pickets, the cannoneers unarmed.

TO BRIDLE THE HORSE.

147. The instructor indicates the parts of the bridle as follows, and explains their uses:—

BRIDLE: *crown piece; throat lash; brow band; cheek straps; bit; bar of bit; curb rein; curb chain or strap; snaffle rein.* He then commands:

BRIDLE.

The reins are taken in the right, the crown piece in the left hand; the horse is approached on the near (or left) side; the reins slipped over his head, and left resting on his neck; the cannoneer then takes the crown piece in the right hand, the left side of the bar of the bit resting on the two front fingers of the left hand; brings the bridle head in front of and slightly below its proper position; inserts the thumb of his left hand into the side of the mouth; presses open the lower jaw; inserts the bit by raising the crown piece; passes his left hand under the brow band, passes the ears under the crown piece, commencing with the right ear; arranges the forelock; secures the throat lash and then the curb strap, taking care not to make them set too closely. There should be at least three finger's breadths between the throat lash and the jaws.

TO SADDLE.

148. The different parts of the saddle are indicated as follows:—The **SADDLE:** *pommel; cantle; seat; skirts; flaps, or inner*

skirts; girths, and straps; stirrups; stirrup leathers; CRUPPER: strap and loop; BREAST STRAP. He then commands:

SADDLE.

The cannoneer approaches the horse on the left side, lays the blanket properly folded on his back, the *edges* on the left side; then seizes it at the withers with the left, at the loins with the right hand; slides it once or twice, from front to rear, to smooth the hair, taking care to raise it in carrying it forward, so as not to brush back the hair. The blanket should be so arranged as to project slightly beyond the saddle, both in front and rear. The breast strap, crupper, and stirrups, being crossed over the saddle, he seizes it at the pommel with the left hand, at the cantle with the right, places it gently on the horse's back, bringing it from the direction of the croup; places it a little in rear, that the crupper may be put on without drawing it back, lets down the crupper and breast strap; steps to the rear, passes the end of the crupper under the dock and buckles it, or passes the tail through the crupper loop, taking care that none of the hair remains under it; steps to the right of the horse, seizes the pommel with the right, the cantle with the left hand, raises and carries it forward without moving the blanket, seeing at the same time that there are no straps caught under it; lets down the girth, running it through the loop of the false martingale, if one is used; then lets down the right stirrup; returns to the left of the horse, sees that the blanket is smooth, and does not compress the withers, which is prevented by raising it slightly over this part; buckles the girth and the breast strap, and lets down the left stirrup.

TO LEAD OUT.

149. The horse being saddled and bridled, at the command **LEAD OUT**, the cannoneer conducts him to the exercise ground. The reins are passed over the neck, and rest on the pommel of the saddle; the cannoneer is on the left of the horse, holds the reins with the right hand, 6 inches from the mouth, the nails under, the hand elevated and firm, to prevent the horse starting.

150. **Position before mounting.** At the command **STAND TO HORSE**, given by the instructor, the cannoneer, standing opposite the lower jaw, on the left of the horse, assumes the position prescribed in No. 3, excepting that he holds the reins with the right hand, about 6 inches from the bit, nails downward.

TO MOUNT.

151. The instructor commands:

1. PREPARE TO MOUNT.

1 pause; 2 motions.

At this command, unhook the sabre, when worn; place the right foot 3 inches in rear of the left, make a face and a half to the right, on both heels, keeping the right foot in front; let go the right rein, slide the right hand along the left rein, take two steps, right foot first, and face to the left on the point of the left foot, so as to bring the right side towards the horse's flank; place the right foot 3 inches in rear of the left, seize the bight of the reins with the right hand, and place the little finger of the left hand between them, back of the hand towards the horse's head; run the left hand down the reins to the horse's neck, about 12 inches from the saddle, and with the right hand draw the reins through the palm of the left, until the hand has a light and equal feeling of the horse's mouth; then let the bight of the reins fall on the off side; grasp firmly a lock of the mane, and the reins with left hand, and let fall the right by the side.

Two. Seize the left stirrup leather, just above the eye of the stirrup, with the right hand; raise the left foot and insert it as far as the ball, or about one-third the foot, and place the right hand on the off side of the cantle of the saddle.

2. MOUNT.

1 pause; 2 motions.

At the command **MOUNT**, spring from the right foot, holding firmly to the mane, and keeping the saddle steady with the right hand; bring the heels together, the knees resting firmly against the saddle, the body erect.

Two. Place the right hand on the pommel to support the body; pass the right leg extended over the croup of the horse without touching; let the body come gently down into the saddle; let go the mane, take one rein in each hand, and insert the right foot in its stirrup without the aid of hand or eye.

The instructor then causes the stirrups to be crossed over the horse's neck, the left one over the right.

152. Before commanding the mount, the instructor will explain the details of the movement, and will allow but a short interval between the first and second parts of its execution; because if the cannoneer were to remain too long on the stirrup the horse would become restive.

EXERCISE AT A HALT.

153. **Position of the cannoneer mounted.** The buttocks bearing equally on the saddle, and well forward; the thighs embracing equally the horse, and stretched only by their own weight and that of the legs; the legs free and falling naturally; the loins supported without stiffness; the upper part of the body at ease, free, and erect, shoulders equally thrown back, arms falling naturally, head erect and easy; one rein of the snaffle in each hand, the fingers closed, the thumb along each rein, the wrists as high as the elbow, and 6 inches apart, the fingers turned towards each other, the upper extremity of the reins leaving the hand on the side of the thumb.

EYES RIGHT—EYES LEFT.

154. As prescribed in No. 4, for the cannoneer dismounted.

TO LENGTHEN THE SNAFFLE REIN.

The instructor commands:

Lengthen left (or right) REIN.

1 pause; 2 motions.

155. At the command REIN, bring the wrists towards each other without turning them in; seize the left rein with the thumb and first finger of the right hand, 1 inch from the left thumb.

Two. Half open the left hand, and allow the reins to slip until the thumbs touch; close the left hand and replace the wrists.

TO SHORTEN THE SNAFFLE REIN.

156. The instructor commands:

Shorten left (or right) REIN.

1 pause; 2 motions.

At the command REIN, bring the wrists towards each other without turning them in; seize the left rein with the thumb and first finger of the right hand, so that the thumbs touch.

Two. Half open the left hand, elevate the right hand, and suffer the rein to slip until the thumbs are 1 inch apart; close the left hand and replace the wrists.

The right rein is lengthened and shortened on the same principle.

TO CROSS THE REINS IN ONE HAND.

157. The instructor commands:

In left (or right) hand—cross REINS.

At the command REINS, turn in the left wrist, the nails downward; at the same time bring the wrist opposite to the middle of the body, half open the left hand, place in it the part of the rein that was in the right; reclose the left hand, and let the right fall to the side.

The reins are crossed in the right hand upon the same principle.

TO TAKE THE REINS IN BOTH HANDS.

158. The instructor commands:

Separate—REINS.

At the command REINS, half open the hand which contains them, seize with the other, nails downward, that part of its rein which the other hand had held, and replace the wrists 6 inches apart.

USE OF THE BRIDLE REINS AND LEGS.

159. The reins serve to prepare the horse for the move-

ments, to guide, and to halt him; their action should be gradual, and in harmony with that of the legs. In using them, the arms should be used with suppleness, and their movements should extend from the wrist to the shoulder. In riding, the hand ought not to move with the body, but should be kept steady.

The legs serve to make the horse advance, to support him, and to aid him in executing changes of direction. When the cannoneer wishes to make his horse advance, he should gradually close his legs behind the girth, proportioning their effect to the sensibility of the horse. In doing this he must be careful not to open out, nor to raise his knees, which must be kept supple. As soon as the horse obeys, the cannoneer will gradually relax his legs.

EFFECT OF THE REINS AND LEGS.

160. The cannoneer, in elevating the wrists and closing the legs, holds his horse in hand or *gathers* him; this is preparatory to all movements. By again elevating the wrists he slackens the pace; and by repeating the movement he stops the horse, or reins him back. The wrists should be raised without curving them, and at the same time they should be drawn slightly towards the body.

In opening the right rein and closing the right leg, the cannoneer turns his horse to the right. To open the right rein, the right wrist is carried, without turning it, more or less to the right, according to the sensibility of the horse.

The horse is turned to the left on the same principles.

By lowering slightly the wrists, the horse is at liberty to move forward. Closing the legs determines the movement.

TO MARCH.

161. The instructor commands:

1. *Cannoneers, forward.* 2. MARCH.

At the first command, gather the horse. At the command MARCH, lower the wrists, closing the legs at the same time until the horse obeys, when the wrists will be gradually replaced.

TO HALT.

162. The instructor commands:

1. *Cannoneers.* 2. HALT.

At the first command, the horse is gathered without slackening his pace. At the command HALT, elevate the wrists by degrees, bring them towards the body, and hold the legs near, to keep the horse straight and to prevent his backing. When the horse does not obey, cause him to feel successively the effect of each rein, according to his sensibility. The horse having obeyed, gradually replace the wrists and legs.

TO TURN TO THE RIGHT OR LEFT.

163. The instructor commands:

1. *Cannoneers, by the right (or left) flank.*
2. MARCH. 3. HALT.

At the first command, gather the horse. At the command MARCH, open the right rein, and close progressively the right leg. In order not to turn the horse too short, perform the movement in a quarter of a circle of 3 yards. The movement being almost completed, diminish the effect of the rein and the right leg, supporting the horse at the same time with the left rein and leg to terminate the movement.

At the command HALT, hold the horse straight in the new direction.

TO REVERSE TO THE RIGHT OR LEFT.

164. The instructor commands:

1. *Cannoneers, right (or left) reverse.*
2. MARCH. 3. HALT.

This movement is executed upon the same principles as the turn to the right or to the left, with this difference: that the horse should pass over a semicircle of 6 yards and halt faced to the rear.

The instructor should place himself on foot, at the shoulder

of the horse, and describe the curves prescribed in this and the preceding number before causing the cannoneer to execute the movements.

TO OBLIQUE.

165. The instructor commands :

1. *Cannoneers, right (or left) oblique.*
2. MARCH. 3. HALT.

This movement is executed according to the principles prescribed for a turn to the right or left, (No. 163,) taking care that the movement of the reins and left leg are called into action in sufficient time to prevent more than a *half turn* being executed. The object being to give the cannoneers the first idea of the oblique direction, great exactness will not at first be required.

TO REIN BACK.

166. The instructor commands :

1. *Cannoneers, backwards.* 2. MARCH.
3. *Cannoneers.* 4. HALT.

At the command MARCH, keep a firm seat, elevate the wrists, and close the legs. As soon as the horse obeys, lower and elevate successively the wrists. If the horse throws his haunches to the right, close the right leg; if to the left, close the left leg. If these means are not sufficient to replace the horse in his proper position, open the rein on the side towards which he throws his haunch, supporting him at the same time with the other rein.

At the command HALT, hold a light rein, and keep the legs near.

167. At first the horse should not be backed more than three or four paces. If necessary, the instructor, dismounted, will place himself before the horse, take a rein in each hand, and by moving the wrists, cause the bit to act. If the horse refuses to obey, the reins being held in one hand, the instructor with the other will touch his forelegs gently with the whip, and caress him as soon as he obeys.

168. In executing the foregoing movements, the instructor

will not at first require that they be performed together by the cannoneers under instruction, but will see that each executes his own correctly, rectifying the positions before passing from one movement to another.

TO DISMOUNT.

169. The instructor causes the stirrups to be let down, and commands :

1. *Prepare to* DISMOUNT.

At this command pass the right rein of the snaffle into the left hand, the extremity of the reins leaving the hand on the side of the thumb, seize the reins above and near the left thumb with the right hand, the nails downward; slide the left hand down the reins to the horse's neck, about 12 inches from the saddle, and holding the reins in that hand so as to feel the horse's mouth lightly, grasp with it a lock of the mane; drop the bight of the reins, and, placing the right hand on the pommel, take the right foot from the stirrup, keeping the body erect.

2. DISMOUNT.

1 pause; 3 motions.

At the command DISMOUNT, rise upon the left stirrup, pass the right leg extended over the croup of the horse, without touching him, and bring the right heel to the side of the left, the body well sustained, at the same time placing the right hand on the cantle.

Two. Lower the body gently until the right foot touches the ground; remove the left foot from the stirrup, and place it by the right, keeping the body erect. Let go the mane; pass the bight of the reins over the pommel of the saddle with the right hand, which then seizes the left rein; let go the rein with the left hand, and drop the hand by the side.

THREE. Face to the left, take two steps, left foot first, slip the right hand along the left rein, and take the position of STAND TO HORSE.

In the detail and execution of the first and second motions of the dismount, the instructor will conform to what is directed in No. 152 for mounting.

TO FILE OFF.

170. The instructor commands :

1. *By the right, (or left,) file off.* 2. MARCH.

At the first command, hook up the sabre, when one is worn. At the command MARCH, the cannoneer on the right steps off with the left foot, leading his horse to the front. He moves four yards, turns to the right, and marches in the new direction, holding at the same time the hand high and firm. Each man executes successively the same movement when the one who precedes him has moved four yards to the front.

They conform to the same principles to file off to the left.

TO UNSADDLE.

171. At the command UNSADDLE, the cannoneer unbuckles the breast strap and girth ; steps to the right side, frees the girth from the loop of the false martingale, turns up the girth and breast strap after wiping them ; throws over the right stirrup ; carries the saddle a little back, and frees the tail from the crupper ; throws over the left stirrup ; seizes the pommel with the left, the cantle with the right hand, removes the saddle and places it on its peg ; takes off the blanket, doubles it with the wet side inwards ; lays it on the saddle, passing the crupper over it, and attaching it to the breast strap.

TO UNBRIDLE.

172. At the command UNBRIDLE, loose the curb strap and throat lash ; slip the reins with the right hand to the crown piece, and then with both hands carefully disengage the ears, and let the bit drop out of the mouth by lowering the crown piece along the forehead.

The manner of arranging the bridle and halter heads, when both are used at the same time, will depend upon the kind of halter head used ; the mode in each case will be prescribed by the captain commanding the battery.

VAULTING: THE HORSE UNSADDLED.

173. At the command MOUNT, the cannoneer seizes the mane with the left hand; holds the reins of the snaffle with the right hand, which he places on the withers, the thumb to the left, the fingers to the right; raises himself lightly on the two wrists, the body straight; passes the right leg extended over the croup of the horse without touching him, seats himself gently, and takes the left rein in the left hand.

At the command DISMOUNT, he passes the left rein of the snaffle into the right hand, which he then places on the withers; seizes the mane with the left hand, raises himself gently on both wrists; passes the right leg extended over the croup of the horse without touching him, brings the right thigh near the left, the body straight, and comes lightly to the ground.

MARCHING.

Riding-house Drill.

174. The instructor may now unite eight cannoneers, but not more. They are placed on the same line, 3 yards apart. After mounting, the stirrups are crossed over the horse's neck. Two corporals, or instructed men, designated *conductors*, are placed, one on the right, the other on the left; they use their stirrups.

When there is no riding-house, a ground will be laid out as a substitute. It should be rectangular, about 100 yards long by 33 broad, the entrance at the ends.

The cannoneer marches *to the right hand*, when he has the right side towards the interior of the riding-house.

He marches *to the left hand*, when the left side is towards the interior.

TO MARCH TO THE RIGHT (OR LEFT) HAND.

175. (PLATE 19, Fig. 1.) The instructor commands:

1. *Cannoneers, by the right (or left) flank.*
2. MARCH. 3. FORWARD.

At the first and second commands, the cannoneers turn to the right, as prescribed in No. 163. At the command FORWARD, they lower the wrists, and, closing the legs, march straight forward and follow the conductor, who enters the riding-house, turning, when he reaches the extremity of it, to the right or left, as directed. He turns at the angles without further orders. If the turn is to the right, the cannoneers are marching to the right hand; if to the left, they are marching to the left hand. They keep the distance between them of 4 feet from head to croup.

The instructor follows, keeping on the inside of the track; observes that the seat is not deranged, and that the men conform with suppleness to the motions of their horses. Passing from one to another he rectifies their positions successively, so as to instruct without confusing them.

TO HALT AND TO MOVE OFF.

176. The cannoneers marching in column on one of the long sides, the instructor commands:

1. *Cannoneers.* 2. HALT.

At the second command, the cannoneers halt. To resume the march, the instructor commands:

1. *Cannoneers, forward.* 2. MARCH.

The men will take care not to incline the body too much forward at the moment of stopping, and not to lean back at the moment of starting. When they halt the instructor will rectify their positions.

TO TROT.

177. After the cannoneers become habituated to the movement of the horse, the instructor commands:

1. *Trot.* 2. MARCH.

At the first command, given when the column is upon one of the long sides of the riding-house or ground, the horse is gathered. At the command MARCH, lower the wrists a little, and close the legs gradually, until the horse obeys; when the wrists and legs will be replaced. The trot is at first at a moderate gait; the

men must sit steady and easily, and maintain the solidity of their positions by the weight of the body, allowing it to conform to the movements of the horse, without lounging, and without bearing upon the reins.

To resume the walk, the instructor commands:

1. *Walk.* 2. MARCH.

At the command *Walk*, gather the horse. At the command MARCH, gradually raise the wrists; at the same time close the legs, to prevent the horse stopping. As soon as he walks, replace the wrists and legs.

All changes of gait should be made gradually.

CHANGES OF HAND.

178. (PLATE 19. Fig. 2.) When the cannoneers have marched some time to *the right hand*, (or to *the left hand*), to make them change hands without stopping, the instructor commands:

1. *File right*, (or *left*.) 2. MARCH. 3. FORWARD.

At the command MARCH, the conductor turns to the right; at the command FORWARD, he moves straight forward, crossing the riding-house, and followed by the other cannoneers, until he arrives within 2 yards of the opposite track, when the instructor commands:

1. *File left*, (or *right*.) 2. MARCH. 3. FORWARD.

At the command MARCH, the conductor turns to the left; and at the command FORWARD, follows the track. The other cannoneers turn upon the same ground.

The changes of hand are executed both at the walk and the trot.

TO CROSS REINS IN MARCHING.

179. The instructor causes the reins to be crossed and separated, as prescribed in No. 157 and No. 158. The cannoneers will avoid abruptness in the motions and not change the gait.

The reins being crossed, in order to turn to the right, carry the

hand forward and to the right; to turn to the left, carry the hand forward and to the left; the nails always downward.

TO TURN BY CANNONEER IN MARCHING.

180. (PLATE 20, Fig. 1.) The cannoneers marching in column, and having arrived about the middle of one of the long sides, the instructor commands:

1. *Cannoneers, by the right (or left) flank.*
2. MARCH. 3. FORWARD.

At the first command, gather the horse. At the command MARCH, each cannoneer executes a turn to the right, and at the command FORWARD, moves straight to the front.

When they arrive within 2 yards of the opposite track, the instructor commands:

1. *Cannoneers, by the right (or left) flank.*
2. MARCH. 3. FORWARD.

When each cannoneer turns as directed, and moves forward on the track.

The same movements, when repeated, bring the cannoneers to their original order.

MARCHING ON THE SAME LINE, TO REVERSE BY CANNONEER.

181. (PLATE 20, Fig. 2.) The cannoneers having turned to the right, as just explained, and being near the opposite track, the instructor commands:

1. *Cannoneers, right (or left) reverse.*
2. MARCH. 3. FORWARD.

At the first command, gather the horse. At the second, each man executes the reverse, and at the command FORWARD, moves directly to the front.

The column is again formed on the track by giving the command:

Cannoneers, by the right (or left) flank—MARCH—FORWARD.

MARCHING IN COLUMN, TO REVERSE BY CANNONEER.

182. The instructor commands:

1. *Cannoneers, right (or left) reverse.*
2. MARCH. 3. FORWARD,

Which is executed by each cannoneer, as already prescribed.

183. The object of the different turns and reverses being to habituate the cannoneers to the control of their horses, they will be executed at first at a walk only, the turns and reverses to the right being executed during the instruction to *the right hand*; and those to the left during the instruction to *the left hand*. After the cannoneers are accustomed to the movements, the instructor causes them to be executed without regard to the change of hand.

TO REST.

184. The instructor causes the turn by cannoneer to be executed to the right, or left. When the column is near the middle of a long side of the riding-house, gives the command HALT; when they are clear of the track, dismounts them, and commands REST.

To terminate the drill, the stirrups are let down, the men dismounted, and ordered to file off.

TO REST IN MARCHING.

185. The instructor sometimes commands REST, whilst the cannoneers are marching, in order to calm the horses after a quick pace, and to relieve the men who may become fatigued. The cannoneers then relax themselves a little, but without lounging in the saddle, changing the pace, or losing the distance. The conductors regulate the march at all times.

186. During the rests, the instructor exercises the men in vaulting on and from their horses, without commands.

To leap to the ground: the cannoneer holding the reins as prescribed in No. 173, seizes with the left hand a lock of the mane, the fingers well closed; places the right hand upon the

pommel; raises himself upon the wrists; brings the right thigh to the side of the left; remains an instant in this position, and descends lightly to the ground.

To leap upon the horse, he seizes the mane with the left hand; places the right hand, which holds the reins, upon the pommel; springs quickly, raising himself on both wrists; remains an instant in this position, and places himself lightly in the saddle.

THE SPUR.

187. For the remaining portion of the riding-house drill from twelve to sixteen cannoneers may be united. The horses are saddled and in the snaffle.

All the movements are explained in detail, and executed *by the right*. They are executed *by the left*, on the same principles. After the cannoneers begin to execute them with facility, they are made to change their horses daily, that they may become habituated to the management of different ones.

The cannoneers are placed in two ranks, the ranks at 2 feet distance; the horses in each rank 1 foot from each other; the conductors of the right or left being first placed in position to serve as the bases of formation for each rank. They are then told off as prescribed in No. 30, calling off as high as No. 8, and beginning again in the rear rank as No. 1, so that the odd numbers are in the rear, the even numbers in the front rank. The instructor then causes them to mount.

TO MOUNT IN TWO RANKS.

188. (PLATE 19, Fig. 3.) At the command *Prepare to mount*, Nos. 2 and 6, and the conductor on the left of the front rank, move 2 yards to the front; Nos. 1 and 5, and the conductor on the left of the rear rank, move 2 yards to the rear, keeping opposite their intervals, and regulating by the right. All unhook their sabres when they are worn, and the mounting is then completed as prescribed in No. 151. The instructor then causes the stirrups to be crossed, and commands:

Form RANKS.

o

At the command RANKS, Nos. 2, 3, 6, and 7 stand fast, and the conductors form on them. Nos. 1, 4, 5, and 8 enter the intervals of their ranks without jostling, and without precipitation. The rear rank being formed, closes to the distance of 2 feet from the front.

189. The instructor then explains the use of the spur.

If the horse does not obey the legs, the spur should be employed. It is only necessary to use it occasionally, but always vigorously, and at the moment the horse commits the fault.

To use the spurs, hold firmly to the horse by the legs; turn the toes a little out; give the rein slightly, and press firmly with the spurs behind the girth, without moving the body, until the horse obeys. He should never be made to feel the spurs unless there is a necessity for it, and then both should be applied at the same moment.

TO CONDUCT THE CANNONEERS TO THE RIDING-HOUSE.

190. (PLATE 19, Fig. 4.) The instructor commands:

1. *By the right (or left) flank.*
2. MARCH. 3. FORWARD.

At the first command, gather the horse. At the command MARCH, the cannoneer on the right of each rank executes a *turn to the right*, and moves forward at the third command, the one of the rear rank approaching in marching to within 1 foot of the one in the front rank. This movement is executed by all the other files in succession.

PLATE 19, Fig. 5. In entering the riding-house, the instructor marches the column parallel to the long sides; and when its head is near the middle, commands:

1. *By file, right and left.* 2. MARCH. 3. FORWARD.

The conductor of the front rank turns to the left, that of the rear rank to the right; when they are within 2 yards of the track, the instructor commands: *File right*—MARCH—FORWARD. The two columns then march to the right hand, and at the same pace; the cannoneers preserve the distance of 4 feet from head to croup.

The conductor of the rear rank regulates his pace by that of the conductor of the front rank, so that they shall arrive at the opposite angles of the riding-house at the same time. The instructor sees that the cannoneers move at a free and even pace; that they keep their horses straight; that they preserve their distances, and recover them gradually when lost; that they gather their horses a little before arriving at each corner, and execute a turn to *the right* or to *the left*, according as they are marching to the right hand, or to the left hand. The movements of each should be independent of those of the one who precedes him, and should alone control his horse.

191. A horse is said to be *straight*, when his shoulders and haunches are upon the same line.

If in marching to the right the horse carries his shoulders to the right, it is necessary to open a little the left rein, and to hold the right leg near. If he carries his haunches to the right, close the right leg and feel lightly the left rein. If he casts himself towards the interior of the riding-house, place him on the track by opening the outer rein and closing the inner leg.

192. The instructor will cause the men to pass frequently from the walk to the trot, and from the trot to the walk. The changes in the gait will be effected gradually.

193. Changes of direction in the breadth of the riding-house will be executed so as neither to stop nor check the rear of either column; for this purpose the change will be commenced soon after the heads of columns have entered upon the long sides of the riding-house.

194. (PLATE 20, Fig. 3.) Changes of direction in the length of the riding-house will be executed upon the same principles as those in the breadth, except that the command *File right* or *left*, will be given by the instructor as the heads of columns are entering upon the short sides, and the command MARCH, when the conductors are within 3 yards of the middle of their sides, so that the columns will pass near each other.

CHANGE OF DIRECTION OBLIQUELY BY CANNONEER.

195. (PLATE 21, Fig. 1.) A change of direction in the length of the riding-house is commenced, and as soon as all the cannoneers have turned, the instructor commands :

1. *Cannoneers.* 2. HALT.

The men halt at their proper distances; the instructor then causes them to oblique *to the right*, (or *left*,) as prescribed in No. 165; rectifies their positions, if necessary, and commands :

1. *Cannoneers.* 2. MARCH.

When all move directly to their front, retaining their direction and relative positions. When they arrive near the track, the instructor commands :

FORWARD.

At this command, each cannoneer executes an oblique *to the left*, (or *right*,) so as to follow the track, and moves forward.

To execute these movements without halting, the instructor, as soon as the two ranks are in column in the length of the riding-house, commands :

1. *Cannoneers, right (or left) oblique.*

2. MARCH. 3. FORWARD.

At the first command, gather the horse. At the command MARCH, each cannoneer executes the oblique, and keeps directly to his front. At the command FORWARD, given when the cannoneers are near the track, they execute an oblique so as to move in the original direction.

196. In all the preceding changes of direction, the instructor is governed as to time, in giving his commands, by the most advanced conductor, and will then rectify the pace of the other.

TO MARCH IN A CIRCLE.

197. When the conductors have passed over about a third of the long sides, the instructor commands :

1. *In circle, to the right (or to the left.)* 2. MARCH.

(PLATE 21, Fig. 2.) At the first command, gather the horse. At the command MARCH, the conductors, followed by the cannoneers, describe circles between the two tracks. Each horse is kept on the circle with the inner rein, supported at the same time by the leg on that side, the haunches, when necessary, being kept in by the outer leg.

TO CHANGE HAND ON THE CIRCLE.

198. The instructor commands :

1. *By file, right (or left.)* 2. MARCH. 3. FORWARD.

(PLATE 21, Fig. 3.) At the command MARCH, the conductors turn to the right, and, at the command FORWARD, pass through the centre of the circle towards the opposite point of the circumference. When they arrive near it, the instructor commands :

1. *By file, left (or right.)* 2. MARCH. 3. FORWARD.

At the first command, the conductors turn to the left, and at the command FORWARD, resume their movement in circle. They are followed successively in these movements by the cannoneers.

The exercise on the circle and changes of hand are executed at a trot, according to the same principles. The instructor will see that the men maintain themselves in the direction of their horses, and sit squarely.

When the instructor wishes to resume the exercise on a right line, he takes care that the conductors are at opposite points of the circumference; and when they arrive on the track of the long sides, he commands FORWARD. At this command, the conductors, followed by the cannoneers, re-enter upon the track.

199. (PLATE 21, Fig. 4.) *To re-unite the cannoneers*, the instructor causes them to close to a distance of 2 feet, then orders a change of direction in the breadth of the riding-house at the moment the conductors are opposite to each other, the even numbers marching towards the entrance. When they arrive near the middle of the riding-house, the instructor commands: *File left and right*—MARCH—FORWARD. The conductor of the front rank turns to the left, that of the rear rank to the right, followed by the cannoneers, who approach within 1 foot of each other.

200. When the column reaches the stable yard, or parade, the instructor commands :

1. *Cannoneers, left into line.* 2. MARCH.

(PLATE 21, Fig. 5.) At the command MARCH, each of the two leading cannoneers turns to the left, moves forward 5 yards, and halts. The other cannoneers execute the same movement in succession, and take their places, each in his own rank, as prescribed in No. 187. They do not execute the turn until nearly opposite their places.

TO DISMOUNT IN TWO RANKS.

201. (PLATE 19, Fig. 3.) At the command PREPARE TO DISMOUNT, Nos. 2 and 6, and the conductor on the left of the front rank, move 2 yards to the front; Nos. 1, and 5, and the conductor on the left of the rear rank, move 2 yards to the rear; the cannoneers of each rank keeping opposite their intervals, and dressing by the right. They then complete the dismount as in No. 169.

As soon as they are dismounted, the instructor commands :

Form RANKS.

At this command, Nos. 2, 3, 6, and 7, elevate the right hand, so as to hold their horses firmly, and the conductors form on them; the other numbers advance and take their proper places in the intervals, and the rear rank then closes to 2 feet. The cannoneers file off as prescribed in No. 170. Each man of the rear rank follows, and conforms his movements to those of his front rank man.

EXERCISE WITH THE STIRRUPS.

202. The stirrups should be of such length that when the cannoneer rises in them there should be a space of not over 4 or 5 inches between his crotch and the saddle. The stirrup should support only the weight of the leg; the foot should be inserted one-third of its length, the heel should be no higher than the toe, and in such position that the spur will not touch the horse in the movements.

Cannoneers Mounted.

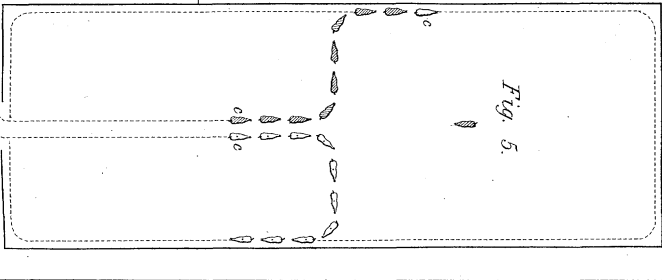
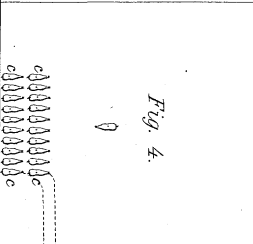
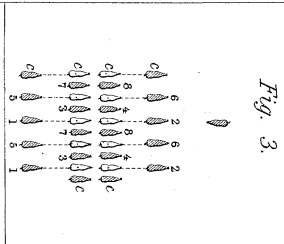
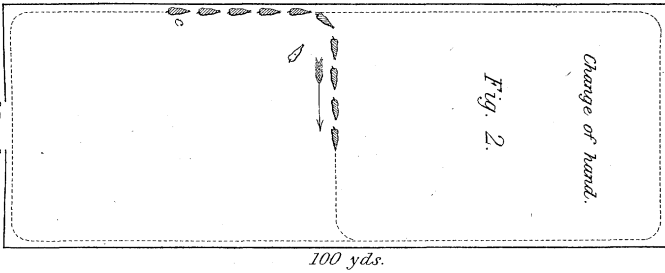
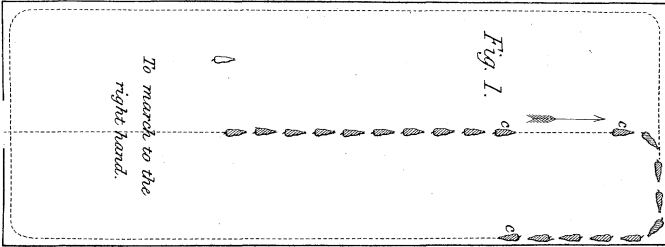

Cannoneers Mounted.

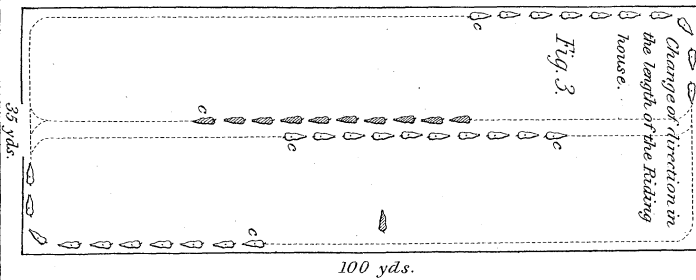
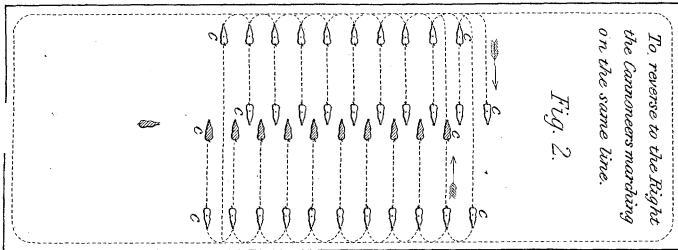
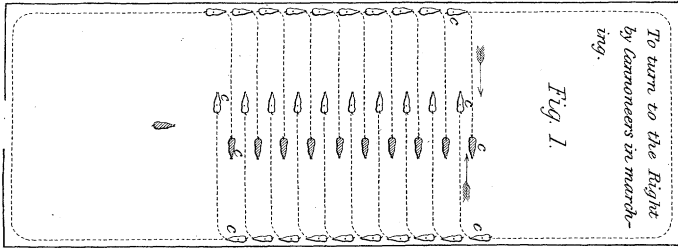

Cannoncers Mounted.

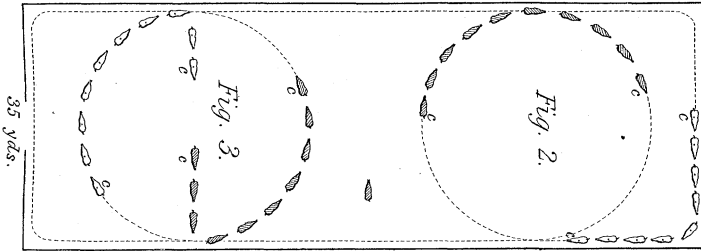
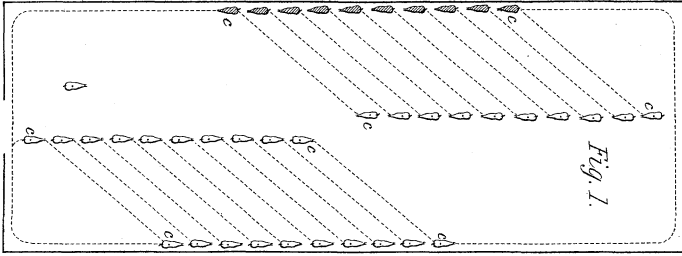

100 yds.

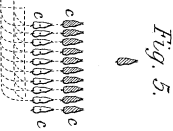
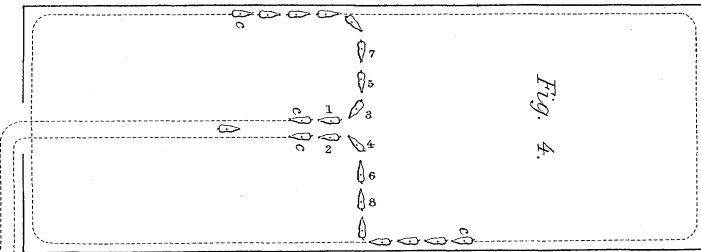

TO TURN TO THE RIGHT OR TO THE LEFT BY CANNONEER, IN MARCHING.

203. (PLATE 20, Fig. 1.) The instructor causes the movement to be executed as prescribed in No. 180. As the cannoneers are marching in two columns, the command MARCH will be given when the leading conductors arrive opposite to the last man but one of the other column.

At the command FORWARD, the cannoneers move straight forward, and pass through the intervals of the opposite column, keeping their legs near to prevent the horses slackening the gait. The instructor should attach less importance to the uniformity of their movements than to the manner in which each cannoneer manages his horse.

204. (PLATE 20, Fig. 2.) The reverse by cannoneer, in line and column, are executed as prescribed in No. 181 and No. 182, the instructor requiring more regularity as the exercise proceeds, and steadiness in passing through the intervals in line.

TO PASS FROM THE HEAD TO THE REAR OF THE COLUMN.

205. To make the cannoneers masters of their horses, and to force them to use both reins and legs, the men will be required to pass in succession from the head to the rear of the column. Each becoming in his turn conductor, will regulate himself accordingly. The movement is executed in each column at the command *Leading cannoneer to rear of column*. The leading cannoneer leaving the head of the column by a *right* or *left reverse*, as indicated by the instructor, moves parallel to it, and again enters it at the rear by another reverse. He leaves the column so as not to retard those behind him, and on re-entering it, closes to 4 feet from the rear horse.

FROM A HALT TO MOVE AT A TROT.

206. The cannoneers being in column, on the long sides, the instructor commands:

1. *Column forward—trot.*
2. MARCH.

At the command *trot*, gather the horse. At the command MARCH, lower the wrists and close the legs progressively until the horse obeys.

To halt, the instructor, when the columns are on the long sides, commands:

1. *Column.* 2. HALT.

The instructor requires all the men to set off freely, at a trot, at the command MARCH, and to stop together at the command HALT.

TO PASS FROM THE TROT TO THE TROT OUT, AND TO RESUME THE TROT.

207. The cannoneers, moving at a trot, on the long sides, the instructor commands:

TROT OUT.

At this command the wrists are lowered, and the legs closed progressively until the horse obeys. When the proper gait is assumed, the instructor will see that the men keep their horses up to it.

Particular attention will be paid to the position of the cannoneers; they must hold the body erect and easy, the legs falling naturally, and hold the reins with a light hand. This will enable them to conform readily to the motions of the horse. The lengthened gait will only be maintained for one or two turns towards each hand in the riding-house.

If a horse overreaches, the wrists must be more or less raised, and the legs closed, to correct it.

To resume the trot, the instructor commands:

SLOW—TROT.

At this command, elevate the wrists by degrees until the horse obeys, closing the legs to prevent his taking *the walk*.

TO PASS FROM THE TROT TO THE GALLOP.

208. When the cannoneers have acquired some suppleness and confidence at *the trot*, and *trot out*, they take a few turns at

the *gallop*. The mechanism of the gait is not at first explained, but each man accommodates himself to the motions of his horse without losing his seat.

The rear rank, when on one of the short sides, is formed in line as prescribed in No. 180, and halted at 6 yards from the track; the front rank continues to march, taking distances of 3 yards between the horses, pass to the trot, and the cannoneers successively commence the gallop at the indication of the instructor as follows:

On approaching the corner, *trot out*, feel slightly the left rein so as to keep back the left shoulder, and leave the right one free. At the moment of passing the corner, close the legs equally, but not suddenly; when the horse gallops, hold a light rein, and the legs closed sufficiently to keep him at the gait.

After one or two turns, pass from the gallop to the trot, and walk; change hands in the breadth of the riding-house, and gallop to the left hand.

The front rank is then formed in line on the other short side, and the rear rank carried through the same exercise.

TO PASSAGE TO THE RIGHT OR LEFT.

209. The two columns marching at a walk, upon the long sides, the instructor causes them to execute the *turn* by *cannoneer*, as prescribed in No. 180, and halts them head to the wall, when they arrive near the opposite side. He then commands:

1. *Right pass.* 2. MARCH.
3. *Cannoneers.* 4. HALT.

At the command MARCH, open the right rein to incline the horse to the right, closing at the same time the left leg, that the haunches may follow without leaning the body to the left; make use of the left rein and right leg to support the horse and moderate his movements.

At the command HALT, given after a few steps have been taken, gradually cease the effect of the right rein and left leg,

employing the opposite rein and leg; straighten the horse, and replace the wrists and legs by degrees.

To passage to the left and to halt, employ the same means.

These movements are at first executed by the men separately, and then together.

The cannoneer should hold his horse obliquely to the track to render his movement more easy; the horse having obeyed, the effect is kept up by gentle means, and the motions and positions of the horse are regulated upon the principles laid down.

210. The passage to the right or left in column is effected on the same principles. For this purpose a change of direction in the length of the riding-house is commenced, and when the columns are parallel to and opposite each other, they are halted and the passage ordered, so as to separate them until each is again on the track, when they march forward, and the movement is repeated, which causes each horse to passage in a direction opposite to the first one.

211. During the last days of instruction with the stirrups, the instructor, in order to prepare the cannoneers for the use of the curb bridle, will cause them, from time to time, to cross reins in the left hand, so that they will conduct the horses with this hand alone. He will see that each man sits squarely on his horse during such exercise.

THE CURB BRIDLE.

212. The horses are taken saddled, and in both curb and snaffle. In the first lesson they conduct the horse to the riding-house with the snaffle, which is held in the right hand; the reins of the curb being in the left.

POSITION OF THE BRIDLE HAND.

213. The reins, with their slide, in the left hand; the little finger between the reins, the other fingers well closed; the thumb upon the second joint of the first finger; the elbow slightly detached from the body, the hand 4 inches above the pommel of the

saddle, the fingers 6 inches from, and turned towards the body; the little finger a little nearer the body than the upper part of the wrist; the right hand at the side.

To adjust the reins, the cannoneer seizes them with the thumb and forefinger of the right hand, at the button or centre, partly opens the left hand so as to let them slide through it, elevates the reins until they bear equally, closes the left hand upon them, and lets fall the end of the reins and the right hand.

To take the snaffle in the right hand, the instructor commands, *snaffle in right hand*; the cannoneer grasps the snaffle with the right hand, nails downward, holds the reins of the snaffle over those of the curb, and lowers the left hand so as not to bear upon the bit. In using alternately the curb and snaffle, the bars of the horse's mouth are relieved. Both should never be used at the same time.

The cannoneers are required to take the snaffle in the right hand during the first exercises with the curb bridle, in order to keep up his right side, which is apt to remain in rear.

At the command *drop snaffle*, the left hand is replaced, and the reins of the snaffle allowed to fall so that they will be under those of the curb, the right hand at the side.

MOVEMENTS OF THE BRIDLE HAND.

214. By raising the hand slightly, and drawing it towards the body, the horse is gathered; by raising it still more, the gait is made slower; by increasing the effect of the hand, the horse is stopped; if increased still more, the horse is moved backwards.

By lowering the hand, the horse is permitted to move forward; by carrying it forward, and to the right, the horse is turned to the right; by carrying it forward, and to the left, he is turned to the left. As soon as the horse obeys, the hand should be replaced.

In all movements of the hand, the arm should act freely and without constraint to the body; and as the effect of the curb is more powerful than that of the snaffle, it should be used progressively, particularly in stopping and reining back.

215. To apply the foregoing principles, the instructor should first take the cannoneers through the EXERCISES AT A HALT, (Nos. 153 to 169,) and then through the MARCHINGS, (No. 174, etc.) He will not require the different movements to be executed simultaneously, but observe the manner in which each man employs his bridle hand. When sufficiently advanced in the different movements with the curb, he will cause them to march upon the track, first *at a walk*, then *at a trot*. The habitual fault with riders being to carry the left hand forward, and to throw back the right shoulder, the instructor is particular in requiring them to keep that hand above the pommel of the saddle, without deranging the position of the body.

216. To take both reins in the bridle hand, the instructor commands:

SNAFFLE IN LEFT HAND.

The cannoneer then passes the reins of the snaffle between the forefinger and thumb of the left hand, nails under, and draws in the hand towards the body until the reins of the curb bridle cease to act upon the bit.

To drop the snaffle: the instructor commands:

DROP SNAFFLE.

The cannoneer lets go the snaffle without inclining the body, retakes the position of the bridle hand, and adjusts the reins.

The snaffle is not taken in the left hand until the men have acquired the habit of conducting their horses with the curb bridle.

To passage to the right with the curb bridle, or with both reins in the left hand, bear the shoulders of the horse to the right by inclining the hand forward and to the right; close the left leg, that the haunches may follow; keep the right leg near, to sustain the horse. In order to cease the passage, straighten the horse; hold the right leg near, and replace the hand and leg by degrees.

The *passage to the left* is executed according to the same principles.

PRINCIPLES OF THE GALLOP.

217. A horse gallops *on the right foot* when the right fore

and hind legs move in advance of those of the left; he gallops *on the left foot* when the left fore and hind legs are in advance. He gallops *true* when he gallops on the right foot in exercising or turning to the right, or on the left foot in exercising or turning to the left, and gallops *false*, if in exercising or turning to the right he gallops on the left foot, or conversely.

A horse is *disunited* when he gallops with the near fore leg followed by the off hind leg, or the off fore leg followed by the near hind leg.

When the horse gallops on the left foot, the rider experiences a sensible movement in his position from left to right. When he gallops on the right foot, the movement of the rider is from right to left. When the horse is disunited, the rider experiences in his position irregular movements; the centre of gravity of the horse is deranged, and his strength impaired.

EXERCISE AT A GALLOP.

218. The cannoneers of the rear rank being formed, as prescribed in No. 208, the instructor causes those of the front rank to take distance of 3 yards, and when they are marching at a trot, and to the right hand, on one of the long sides, he commands :

1. *Gallop.* 2. MARCH.

At the command *Gallop*, gather the horse, keep him perfectly straight, and at the command MARCH, carry the hand slightly forward, and to the left, to enable the right shoulder to move in advance of the left, and close the legs behind the girth, in order to urge the horse forward, causing him to feel lightly the effect of the left leg. The horse having obeyed, hold a light hand, and the legs near, to keep him at his gait.

The men must conduct their horses steadily and quietly, and keep a light hand, that the gallop may be free and regular. At first they will take the reins of the snaffle in the right hand, to calm their horses; afterwards they will gallop with the curb bridle alone.

To keep the horse true, the rider should accommodate himself to all his motions, particularly in passing the corners. When the horse gallops false, or is disunited, the cannoneer is ordered to take the trot and pass to the rear of the column, taking care not to interfere with those who follow. When he arrives at the rear, he resumes the gallop, and the instructor explains again the manner of keeping the horse true. Only one or two turns will be made at a time at the gallop to each hand, and the cannoneers pass to the trot in order to change hand. When the horses become quiet and readily managed, the distance between them is reduced gradually to 4 feet.

The rear rank is carried through the same exercises, and then both ranks at the same time.

219. When the cannoneers have been sufficiently exercised at the gallop on straight lines, the instructor causes them to take a few turns on the circle, following the principles already prescribed for exercises in the circle.

The exercise will commence on very large circles, which will be progressively diminished as the cannoneers acquire skill in the management of their horses.

220. During the last few days of instruction in the foregoing exercises, the men will repeat the movements, wearing their sabres sheathed, in order that both they and the horses may become accustomed to them. The first movements with the sabre worn, will be at a slow gait, which will not be increased until the horses become perfectly calm.

MANUAL OF THE SABRE.

221. The cannoneers marching by flank as in No. 190, the instructor halts the front rank, and when the rear rank is disengaged, forms it to the left in line as directed in No. 200, after which the front rank is formed on its left in the same manner.

The instructor then commands :

Draw—SABRE.

2 motions.

At the command *Draw*, incline slightly the head to the left;

carry the right hand above the reins, engage the wrist in the sword knot, seize the gripe; draw the blade 6 inches from the scabbard, and turn the head to the front.

At the command **SABRE**, draw quickly the sabre, raising the arm to its full length; hold the sabre in this position an instant, then carry it to the right shoulder, the back of the blade supported against the hollow of the shoulder, the wrist upon the top of the thigh, the little finger outside the gripe.

Present—**SABRE**.

222. At the command **SABRE**, carry the sabre forward, the thumb opposite to and 6 inches from the neck; the blade perpendicular; the edge to the left; the thumb along the side of the gripe; the little finger joined to the others.

Carry—**SABRE**.

223. At the command **SABRE**, carry the back of the blade against the hollow of the shoulder, the wrist upon the upper part of the thigh, the little finger outside the gripe.

Inspection of **SABRE**.

2 pauses; 3 motions.

224. At the command **SABRE**, present the sabre.

TWO. Turn the wrist inwards, exhibit the other side of the blade, and turn the wrist back.

THREE. Carry the sabre to the shoulder.

Return—**SABRE**.

2 motions.

225. At the command *Return, present* the sabre.

At the command **SABRE**, carry the wrist opposite to and 6 inches from the left shoulder; lower the blade along the left arm, the point to the rear; incline the head slightly to the left, and fix the eyes upon the mouth of the scabbard; return the blade, disengage the wrist from the sword knot, turn the head to the front, and adjust the reins.

226. The cannoneers will be required to *draw*, and *return sabre* whilst marching at a walk in column, the instructor taking care that neither the seat, nor the position of the bridle hand is

deranged, that the right shoulder is not thrown back when the sabre is drawn, and that the horse is kept steadily at his gait. As they become more skilful, the sabre is drawn first at a trot, then at the gallop. In returning the sabre at a walk, the back of the blade rests against the left arm, until its point has entered the scabbard.

The *turns* to the right and left with the sabre drawn, are executed at a trot and a gallop; the *reverses*, at a trot only.

SABRE EXERCISE.

227. The cannoneers marching *at a walk* in two columns, the instructor causes one of them to halt until the other closes up. He then causes the cannoneers to take the distance of 2 yards from each other, and when they are upon a long side of the riding-house, commands:

1. *By the right (or left) flank.* 2. MARCH. 3. HALT.

He causes them then to execute the sabre exercise, as taught *on foot*.

For the exercise at a halt, the instructor employs only the time necessary to make the cannoneers comprehend the details.

They then execute progressively, at the different gaits, the exercise of the sabre, taking care to preserve between each other the distance of 2 yards.

TO LEAP THE DITCH AND THE BAR.

228. For this exercise the width of the ditch should be from 3 to 5 feet, and the height of the bar from 1 to 3 feet. The width and height of each should at first be the minimum; they are increased as the men and horses become more habituated to leaping.

The instructor forms the cannoneers in one rank, 30 yards in rear of the obstacle.

At the warning of the instructor, each man moves off *at a walk*, directs his march towards the obstacle, and at a third of the way commences *the trot*.

TO LEAP THE DITCH.

229. On arriving near the ditch, give the hand and close the legs, to force the horse to make the leap. The moment he reaches the ground, raise slightly the hand in order to sustain him.

TO LEAP THE BAR.

230. On arriving near the bar, rein up the horse slightly, and close the legs. At the moment of making the leap, give the hand, and elevate it slightly as soon as he reaches the ground on the other side.

The cannoneer, in leaping, should cling to the horse with the thighs and calves of the legs, taking care to lean a little forward as the horse is in the act of springing, and to seat himself well, by leaning to the rear at the moment the horse reaches the ground.

Each man, after having made the leap, continues to move *at the trot*, and takes his place in the rank which is formed 30 yards beyond the obstacle, taking care to pass to the walk just before halting.

During the first days of this exercise, the cannoneers leap without arms, the instructor causing them to take the snaffle in the right hand. Afterwards they repeat the same exercise with arms, and finally with the sabre drawn.

Horses should not be made to leap more than two or three times in any one day.

ARTICLE SIXTH.

THE DETACHMENT.

Horse Artillery.

231. The detachment is formed in two ranks, with closed intervals; the distance between the ranks 2 feet, measuring from head to croup. It is told off as in mounted artillery, excepting that two additional men, required as horse holders, and numbered 9 and 10, are posted, No. 9 in the centre of the rear, No. 10 in the centre of the front rank. The gunner, when not himself the instructor, takes his place on the right of the front rank.

In *battery manœuvres*, No. 8 is posted with the caisson, of which he is chief, and manœuvres with it. He is replaced in the detachment by the gunner.

TO MOUNT AND DISMOUNT IN TWO RANKS.

232. **To mount.** The instructor commands:

1. *Prepare to mount.*
2. MOUNT.

(PLATE 22.) At the command *Prepare to mount*, the gunner, No. 4, and No. 6, move 2 yards to the front, Nos. 3 and 5, 2 yards to the rear, covering their intervals; the mounting is then completed. The instructor then commands:

Form—RANKS.

At this command, the gunner and Nos. 4 and 6 stand fast, and the others form on them without jostling or precipitation, the rear rank closing up to 2 feet.

233. **To dismount.** The instructor commands :

1. *Prepare to dismount.*
2. **DISMOUNT.**

(PLATE 22.) At the first command, the gunner and Nos. 4 and 6 move forward, and Nos. 3 and 5 rein back 2 yards, and the dismount is completed. The instructor then commands *Form—RANKS*, which is executed by the cannoneers leading their horses into the proper intervals, and closing up the ranks, as in the directions for mounting.

TO FORM IN ONE RANK.

234. The instructor commands :

1. *Left into single rank.*
2. **MARCH.**
3. **HALT.**
4. *Right-DRESS.*
5. **FRONT.**

At the command **MARCH**, the gunner advances 5 yards, and halts. No. 8 turns short to the left, and moves forward; he is followed by the other even numbers, who execute successively the same movement. At the command **HALT**, given in time to enable him to take his proper distance, No. 8 turns short to the right, and moves forward, until on a line with the gunner. The other even numbers turn in time to place themselves in rank successively, on the right of the cannoneer, who precedes him. At the command *Right-DRESS*, the odd numbers move to their front, and align themselves on the gunner. At the command **FRONT**, all cast their eyes to the front.

ALIGNMENTS.

235. **General principles.** The cannoneers in dressing must square their shoulders by those of the man next to them on the side towards the guide, and cast their eyes in that direction, until they see the breast of the second man from them; feeling lightly the boot of the man on that side, and keeping their horses straight on the line. When there are two ranks, the rear rank men cover their front rank men accurately, preserving the distance of 2 feet from head to croup.

236. **Successive alignment of files—to the front.** Two or more files of the right are moved forward, and aligned by the commands *Two (or—) right files forward—MARCH—HALT—Right-DRESS.* The instructor then commands :

1. *By file, Right-DRESS.* 2. **FRONT.**

At the first command, the files move forward successively; the cannoneers turning the head to the right, and taking the last steps slowly, so as not to pass the line. Each file moves when the preceding one arrives on the base of alignment. When the last file is aligned, the instructor commands **FRONT**, and all turn their heads in that direction.

237. **To the rear.** Two or more files of the right are made to rein back 2 yards, and align themselves opposite their places; by the commands *Two (or —) right files backward—MARCH—HALT—Right-DRESS.* The instructor then commands :

1. *By file, Right backward-DRESS.* 2. **FRONT.**

At the command **DRESS**, the files rein back in succession, keeping perfectly straight. The cannoneers turning their heads to the right, pass a little the files already formed, and then dress up.

The cannoneers rein back slowly. When there are two ranks, the rear rank men regulate themselves on their file leaders, preserving always their proper distance. When the last file is aligned, the command **FRONT** is given.

238. **To align the detachment.** The instructor places the file of the flank on which he wishes to align it, in such position that no cannoneer will be forced to rein back, and commands :

1. *Right-DRESS.* 2. **FRONT.**

At the first command, all the cannoneers align themselves promptly. At the second, they cast their eyes to the front.

The alignments are made to the left on the same principles.

The alignment to the rear gives the means of returning to the alignment when it has been passed over, but it should be avoided as much as possible.

The cannoneers should always align themselves on the breast of the second man towards the side of the alignment, and not

upon the extremity of the rank; the rear rank men being careful to cover accurately their file leaders. The men will align themselves promptly, that the horses may not be kept a long time gathered.

239. When the cannoneers are not aligned, it is generally because the horses are not straight in the ranks. In dressing to the right, if the men on the left of the detachment are in rear, it is presumed that most of the horses are turned to the left. If this is the case, the horse is placed on the alignment by carrying the hand to the right and closing the right leg. If, after squaring his horse, a cannoneer finds himself behind the line, he moves forward.

If, in dressing to the right, the cannoneers on the left are in advance of the line, it is presumed that the horses are turned to the right. To rectify this, carry the hand to the left, closing the left leg; those who are still in advance will then rein back.

In dressing to the left, the same faults are corrected by inverse means.

240. During the alignments the instructor places himself in front of the cannoneers, to see that they move steadily, and do not turn the head too much; that they do not open the knee in order to feel the boot; that they prevent their horses from crowding those already formed; that they take the last steps slowly; align themselves without losing time, and give the hand at once.

The alignments will be occasionally interrupted by marches, in order to calm the horses.

TO FORM IN TWO RANKS.

241. The detachment being formed in one rank, the instructor commands:

1. *Right into two ranks.* 2. MARCH.
3. *Right-DRESS.* 4. FRONT.

At the command MARCH, the gunner advances 5 yards, and halts. No. 2 turns to the right, moves along the front of the odd numbers, and turns short to the left in time to halt square in

front of No. 1. The other even numbers follow his movements, and form on his left. As soon as the front rank is in position, the rear rank takes the distance of two feet, and at the third and fourth command the detachment is aligned to the right.

When formed in two ranks, the detachment will be taken through the foregoing movements together.

TO OPEN AND CLOSE THE RANKS.

242. **To open the ranks.** The instructor commands :

1. *To the rear, open order.* 2. MARCH.
3. *Right-DRESS.* 4. FRONT.

At the command MARCH, the front rank remains immovable; the rear rank reins back 6 yards, each cannoneer preserving the direction of his file leader. At the third command, the rear rank is aligned to the right.

243. **To close the ranks.** The instructor commands :

1. *Close order.* 2. MARCH.
3. *Right-DRESS.* 4. FRONT.

At the command MARCH, the rear rank closes to the distance of 2 feet from the front, each cannoneer accurately covering his file leader. At the third command, the detachment is aligned to the right.

TO REIN BACK THE DETACHMENT.

244. The detachment being at a halt, the instructor commands :

1. *Detachment, backwards.* 2. MARCH.
3. *Guide-RIGHT.*

At the command MARCH, all the cannoneers rein back at once, following the principles already prescribed for the movement, and regulating themselves by the guide.

After they have reined back some steps, the instructor commands :

1. *Detachment—HALT.*
2. *Right (or left) DRESS.* 3. FRONT.

TO MARCH THE DETACHMENT BY FILE.

245. **To the front.** (PLATE 22.) The detachment being at a halt, the instructor commands :

1. *Double files from the right.* 2. MARCH.

At the first command, the cannoneers of the right file gather their horses, as do the others, in succession, as soon as the file on their right is in motion.

At the command MARCH, the right file moves straight to the front. Each of the other files move as soon as the rear rank man of the file on its right is on a line with its front rank man. These two cannoneers advance 5 yards abreast, oblique to the right; march in the new direction until nearly opposite their places, when they oblique to the left, so as to enter the column; the rear rank man then quickens his pace, and takes his position at the side of his proper front rank man.

To break the detachment *by the left*, the movement is executed according to the same principles, at the commands :

1. *Double files from the left.* 2. MARCH.

246. **To the right (or left.)** The instructor commands :

1. *By the right (or left) flank.* 2. MARCH. 3. FORWARD.

(PLATE 19, Fig. 4.) At the first command, gather the horses. At the command MARCH, the cannoneer on the right (or left) of each rank executes a turn to the right, (or left,) and moves forward, the one in the rear rank approaching his front rank man. This movement is executed by all the other cannoneers in succession.

When the gunner is in the ranks, he constitutes a file; all the movements are made as if he were an even number, and the file complete.

247. To form the detachment by file when it is in march, the same commands are given as if it were at a halt. At the command MARCH, all the cannoneers except the file which commences the movement halt, if the detachment is at a walk; or walk, if it is at a trot; and the movement is executed as already directed, in resuming the original gait.

DIRECT MARCH IN FILE.

248. The even numbers are guides; they preserve the distance of 2 feet from head to croup, move steadily, and regain the distances gradually when lost. The odd numbers dress on their guides, keeping up lightly the touch of the boot.

CHANGE OF DIRECTION IN FILE.

249. The column marching, the instructor commands:

1. *By file, left (or right).*
2. MARCH.
3. FORWARD.

At the command MARCH, the left (or right) cannoneer at the head of the column executes the turn; the cannoneer abreast of him conforms to the movement, increasing his gait and keeping up the touch of the boot. At the command FORWARD, both move to the front at the original gait.

The other cannoneers execute the same movement on the same ground.

TO HALT AND TO MOVE OFF.

250. To halt the column, the instructor commands:

Column—HALT.

To resume the march, he commands:

1. *Column, forward.*
2. MARCH.

OBLIQUE IN FILE.

251. The column marching, the instructor commands:

1. *Cannoneers, left (or right) oblique.*
2. MARCH.

At the command MARCH, each cannoneer obliques to the left; the leading cannoneer of the left file is the guide of the column, and moves straight forward in the new direction; the other cannoneers of that file move in the same direction, and on a line with him. The cannoneers of the right file dress on their guides, each placing his left knee behind the right knee of his guide, keeping the head of his horse on a line with the shoulders of the horse on his left, and marches in this way during the oblique.

To return to the primitive direction, the instructor commands :

FORWARD.

The oblique to the right is executed on the same principles.

252. In the oblique march, the guide is always on the side towards which the oblique is made; and, at the command FORWARD, returns to the original side. The change of guides will be made without any special commands.

If the guide of any rank ceases to be on the line of the guide of the column, he quickens or shortens the pace without changing direction, in order to recover his place. If the other cannoneers become disunited, they rejoin the guide of their rank, taking care not to lose their alignment, nor to retard those who march behind them.

TO BREAK INTO SINGLE FILE.

253. The column marching in double file, the instructor commands :

1. *In single file.* 2. MARCH.

At the command *single file*, all the cannoneers, except the even number at the head of the column, prepare to halt. At the command MARCH, they halt. As soon as the odd number of the first rank is passed by the horse of the even number, he enters the column by two successive oblique movements. Each rank of two executes in succession the same movement, the even numbers breaking as soon as the odd number of the rank in front commences obliquing to enter the column. The gait is regulated so as to keep the distances.

When the column is at a trot or gallop, it is broken into single files according to the same principles and by the same commands; the even number of the leading rank continues the gait; the others coming to a walk in case the column is at a trot, or a trot in case it is at a gallop, as soon as the command MARCH is given, and resuming the original gait to enter the column.

254. The column by single file may be formed from the detachment when in line, by the commands :

1. *Single file from the right.* 2. MARCH.

At the command **MARCH**, the file indicated moves to the front. When the croup of the rear rank horse is opposite the head of the leading horse of the next file, that file puts itself in motion, advances 5 yards, obliques to the right, and again to the left, so as to enter the column. Each file takes up the movement in succession, governing itself by that of the file on its right.

The column is formed in single file from the left on the same principles.

The movement in single file will never be used in the artillery except when unavoidable.

TO FORM IN DOUBLE FILES.

255. The column being in single file, marching, or at a walk, the instructor commands:

1. *Double files.* 2. **MARCH.**

At the first command, all gather their horses. At the command **MARCH**, the odd numbers oblique to the right, if the right is in front; to the left, if the left is in front; and, by another oblique, place themselves at the sides of their even numbers, quickening the gait for the purpose if the column is in march. All close up to 2 feet from head to croup.

TO FORM THE DETACHMENT IN LINE.

256. **To the front.** The detachment marching in double files, right in front, the instructor commands:

1. *Cannoneers, into line.*

2. **MARCH.** 3. *Guide-right.*

At the first command, all gather their horses; the odd numbers slacken their gait until they are on a line with the next even number behind them.

At the command **MARCH**, the guide of the column continues to advance; the other cannoneers oblique to the left, quickening their gait, until opposite their places in line; then they oblique to the right, and form in succession in line, each in his proper

rank. The instructor gives the command for the guide immediately after the command MARCH.

When the detachment is at a halt, the leading guide, at the first command, moves forward 5 yards and halts, and the movement is executed as already directed, except that instead of the command for the guide, the instructor commands :

3. *Right-DRESS.* 4. FRONT.

257. **To the right.** The instructor commands :

1. *Cannoneers, on right into line.* 2. MARCH.

3. *Right-DRESS.* 4. FRONT.

At the first command, the odd numbers slacken the gait until they are on a line with the next even number behind them.

At the command MARCH, the guide of the column turns to the right, advances 5 yards, and halts; the other cannoneers continue to advance, turn in succession to the right, and form in line; each in his proper rank.

258. **To the left.** The instructor commands :

1. *Cannoneers, to the left into line.* 2. MARCH.

3. *Right-DRESS.* 4. FRONT.

At the first command, gather the horses. At the command MARCH, each of the two leading cannoneers turns to the left, moves forward 5 yards, and halts. The other cannoneers execute the same movement in succession, when they are nearly opposite their places, and take their proper positions in line; each in his own rank.

In forming line to the right, and to the left, the command *Right-DRESS* is given when the leading cannoneer halts. The command FRONT is given when the last file is aligned.

259. When the column is moving left in front, the line is formed to the *front, left, and right*, on the same principles.

DIRECT MARCH IN LINE.

260. It is important in the direct march to keep the horses straight in the ranks. To keep themselves aligned, the cannoneers should feel lightly the boot of the man on the side of the

guide, march at an equal gait, and preserve the head direct. They should yield to all pressure coming from the side of the guide, and resist that coming from the opposite side.

The guide should march at a free and steady gait, and change it with steadiness, in order to avoid irregularity in the ranks.

If the cannoneers are in front, or in rear of the alignment, too near or too far from the man on the side of the guide, they move from or approach him gradually, and in gaining ground to the front.

When there is too much pressure on the guide, he extends his arm to the front, and the cannoneers carry the bridle hand to the opposite side, in order to relieve him.

The cannoneer of the flank opposite the guide is not required to preserve the head direct; he aligns himself on the general front of the detachment, and on the guide, which is commanded alternately, to the right and left. When halted, the alignment is ordered towards the side of the guide.

261. The detachment being in line, the instructor commands:

1. *To the left, (or right,) open files.* 2 MARCH.
3. *Right (or left) DRESS.* 4. FRONT.

At the command MARCH, all the cannoneers, except the right file, passage to the left; the next cannoneer straightens his horse, and halts as soon as he has gained an interval of 1 yard. Each of the other cannoneers executes the same movement, regulating the interval by the man on his right.

The cannoneers of the rear rank follow their file leaders, and keep their proper intervals.

The instructor orders the alignment as soon as the second man from the right has attained his interval. When it is completed, the instructor indicates to the guide of the right, or of the left, a fixed point, in a direction perpendicular to the front of the detachment; he instructs him to take an intermediate point; never to lose sight of these two; and to select a more distant point as he approaches the one nearest to him.

To give a point of direction, the instructor places himself

exactly behind the right file, or the left file, and indicates to the cannoneer of the front rank an object on the ground, which is immovable, and can be distinctly seen; such as a steeple, a tree, or a house; the cannoneer of the rear rank keeps himself always in file, and at his proper distance.

262. To march the detachment forward, the instructor commands :

1. *Detachment, forward.* 2. MARCH.
3. *Guide—RIGHT, (OR LEFT.)*

At the command MARCH, which is immediately followed by that for the guide, all the cannoneers move straight forward, at the same gait with the men on the side of the guide, towards whom, as they are not boot to boot, they should give a glance from time to time.

During the march, the instructor is sometimes at the side of the guide, to assure himself that the men march on the same line, and sometimes behind the guide, to observe that he follows the direction indicated.

To halt the detachment, he commands :

1. *Detachment—HALT.* 2. *Right (or left) DRESS.* 3. FRONT.

263. The cannoneers having been sufficiently exercised in marching with open files, the instructor halts the detachment, and commands :

1. *To the right, (or left,) close files.* 2. MARCH.
3. *Right (or left) DRESS.* 4. FRONT.

At the command MARCH, all the cannoneers, except the right file, passage to the right, and resume their places, boot to boot.

264. After the files are closed, the detachment is put in motion by the commands prescribed in No. 262.

The cannoneers move straight forward; feeling lightly the boot towards the side of the guide.

265. When the men begin to manage their horses properly at the walk, they are required to open and close files whilst marching at the same gait, the instructor taking care not to repeat these movements too often, but to make them march some time after

having opened the files before closing them, and after having closed the files before opening them. For this purpose he commands:

1. *To the left, (or right,) open files.* 2. MARCH.

At the command MARCH, all the cannoneers, except the right file, oblique to the left, quickening the gait so as to preserve their alignment. When they are 1 yard from the man on the right, they straighten their horses, and move forward.

To close files, the instructor commands:

1. *To the right, (or left,) close files.* 2. MARCH.

Each cannoneer, except the guide, obliques to the right until closed, preserves the alignment, and resumes the march to the front, without pressing on the man towards the side of the guide.

The files are always opened from and closed towards the direction of the guide.

266. These movements having been executed to the right, and to the left, in marching at the walk, are repeated at the trot, in passing frequently from the walk to the trot, and from the trot to the walk. The detachment is then exercised in commencing the trot from a halt, and in halting whilst marching at this gait.

267. To exercise the cannoneers in the direct march at the gallop, the same progression is followed as at the walk and trot, except that the ranks are neither opened nor closed. The rear rank preserves exactly its distance. When exercising at a gallop, the detachment should habitually pass to the trot and the walk before being halted; but when the cannoneers are masters of their horses, it may be halted sometimes without changing the gait.

WHEELING.

268. **General principles.** In executing a wheel whilst the detachment is in march, the conductor of the marching flank should increase his gait, and describe his arc so as to cause the files neither to open nor close. The pivot describes an arc of a circle of 2 yards radius in slackening the gait. The cannoneers from the centre to the marching flank increase, and those from the

centre to the pivot decrease the gait progressively, so that the centre man preserves the gait at which the detachment was marching. At the end of the wheel, all resume the original gait, and straighten their horses.

The conductor of the marching flank should measure with his eye the arc of the circle he is to pass over, so that it may not be necessary for the files either to open or close. He turns his head occasionally towards the pivot; if he perceives that the cannoneers are too much crowded, or too open, he increases or diminishes gradually the extent of his circle, in gaining more ground to the front than to the side. Each cannoneer of the front rank should describe his circle in the ratio of the distance at which he may be from the pivot; when opened, they should approach the pivot insensibly, diminishing their circle by degrees. When too much closed, they should increase the circle gradually.

At the command FORWARD, they cease to wheel, and resume the direct march, at whatever point of the wheel they may be. The flanks which become pivots, or marching flanks, do not slacken or augment the pace until the command of execution is given.

269. The wheelings are executed at first in single rank; for this purpose the detachment is formed in one rank, and, being aligned, the instructor commands :

1. *Detachment in circle, right (or left) wheel.*

2. MARCH.

At the command MARCH, the cannoneers put themselves in motion, the pivot describing the arc of a circle of which the radius is 2 yards, at a slow gait; the marching flank moves briskly, and regulates itself by the pivot, avoiding all pressure in the ranks.

270. When the detachment has executed several wheels, to halt it, the instructor commands :

1. *Detachment, HALT.* 2. *Left (or right) DRESS.* 3. FRONT.

At the command HALT, the cannoneers straighten their horses, and halt with steadiness. Before dressing the detachment, the

cannoneer on the marching flank is made to come up abreast of the pivot man, so that the others will not have to rein back in order to align themselves.

271. The detachment is then marched forward, and made to recommence the wheel whilst marching, and by the same commands. At the first command the pivot man prepares to slacken, and the marching flank to quicken the gait, so that the centre man will preserve the gait at which he was marching; the wheel is then executed as prescribed. When the instructor wishes the detachment to take the direct march instead of halting, he commands:

1. FORWARD. 2. *Guide right, (or left.)*

At the command FORWARD, the pivot resumes the gait at which it was previously marching, the other cannoneers straighten their horses, and the two flanks move forward at the same gait, conforming to the principles of the direct march.

When the cannoneers have executed several wheels to the right, and to the left, interrupted occasionally by direct marches, and when the horses become calm, the instructor causes them to pass to the trot. After several wheels at the trot, they resume the walk.

272. When sufficiently exercised in single rank, the cannoneers are formed in two ranks, and the wheels executed in following the same gradation. The instructor commands:

1. *Detachment in circle, right (or left) wheel.*

2. MARCH.

At the command MARCH, the men of the front rank execute the movement as prescribed in No. 269, the cannoneers of the rear rank turn the head, and carry the hand towards the marching flank, so that each one may be out of the direction of his file leader by two men. For this purpose, the moment the wheel commences, each rear rank man executes a quarter turn to the left, if the wheel is to the right; to the right, if the wheel is to the left, keeping, during the wheel, in the direction of his new file leader, and remaining at the distance of 2 feet from the front

rank. The two rear rank men on the marching flank, who are without file leaders, should describe their circle without being farther outside of the front rank than is necessary, and be able to resume their places behind their file leaders easily. During the wheel they should regulate their gaits so that the rear rank, which aligns itself upon them, may be at its proper distance.

273. To stop the wheel, the instructor commands:

1. *Detachment.* 2. HALT.
3. *Left (or right) DRESS.* 4. FRONT.

At the command *Detachment*, the rear rank men straighten their horses, and return to the direction of their file leaders. At the command HALT, all the cannoneers halt.

The detachment is then marched to the front, and made to repeat the same movement.

274. When the instructor wishes the detachment to resume the direct march, he commands:

1. FORWARD. 2. *Guide left (or right.)*

At the command FORWARD, the rear rank men replace themselves behind their file leaders, and march straight forward.

When the cannoneers have acquired the skill necessary to avoid confusion in the execution of the foregoing movements, they are repeated *at the trot*.

275. The detachment being in line, at a halt, or in march, to place it in a position perpendicular to the original front, the instructor commands:

1. *Detachment, right (or left) wheel.* 2. MARCH.
3. HALT. 4. *Left (or right) DRESS.* 5. FRONT.

Which commands are executed on the same principles as the wheel in circle, a quarter of a circle only being described, and the command HALT given when the wheel is nearly completed.

276. The detachment being in line, at a halt, or in march, to place it in a direction oblique to the original front, the instructor commands:

1. *Detachment, right-half, (or left-half,) wheel.* 2. MARCH.
3. HALT. 4. *Left (or right) DRESS.* 5. FRONT.

Which is executed as in the wheel, except that the eighth of a circle only is passed over.

277. The detachment being in line, at a halt, or in march, to place it in a position faced to the rear, the instructor commands:

1. *Detachment, right (or left) reverse.* 2. MARCH.
3. HALT. 4. *Left (or right) dress.* 5. FRONT.

Which commands are executed as prescribed in No. 275, except that a semicircle is described.

278. In all the wheels, when, instead of halting, it is desired to move forward at their completion, instead of the commands 3. HALT, etc., the commands will be: 3. FORWARD. 4. *Guide right (or left.)* The command FORWARD is given as soon as the detachment is in the new direction; all the cannoneers resume the march to the front, and the command for the guide follows immediately.

The foregoing movements being properly executed, from a halt and at a walk, are repeated at a trot.

OBLIQUE IN LINE.

279. The detachment marching in line, to cause it to gain ground towards one of its flanks without changing the front, the instructor commands:

1. *Cannoneers, right (or left) oblique.* 2. MARCH.

At the command MARCH, the cannoneers execute an oblique to the right, so that the head of each horse may be opposite the shoulders of the horse on his right, and that the right knee of each cannoneer may be in rear of the left knee of the man on his right. The men then move in the new direction, regulating upon the guide. When the detachment has obliqued sufficiently, the instructor commands:

FORWARD.

The cannoneers straighten their horses, and move forward.

When in the execution of an oblique march, the guide is always on the flank of the detachment towards which the oblique is made;

and after the command FORWARD, the guide returns, without a command, to the side on which it was when the oblique was ordered. *This rule is general.*

When the cannoneers are not closed, they increase the gait; when too much closed, or more advanced than the guide, they slacken the gait.

280. The detachment marching at a walk, to execute the oblique at a trot, the instructor commands:

1. *Cannoneers, right (or left) oblique—trot.*
2. MARCH. 3. FORWARD.

The guide commences the trot without precipitation.

The same principle is applied when the detachment is at a trot, and the object is to oblique at a gallop.

CHANGES OF GAIT.

281. When the detachment has been sufficiently instructed in the different movements at a walk, the gaits may be changed during their execution, at the command of the instructor.

To pass from one gait to another, the instructor commands:

1. *Trot, (trot out, or gallop.)* 2. MARCH.

And the cannoneers pass to the gait indicated, the instructor seeing that they conform to what is prescribed in Nos. 206 and 207.

To move at the rapid gaits from a halt, in executing the foregoing movements, the instructor adds the command *trot, trot out, or gallop*, to the command of preparation, immediately preceding that of execution, as in No. 280, for obliquing at a trot.

282. *All changes of gait must be made gradually*, and care must be taken never to check a horse so suddenly as to injure his mouth, or throw him on his haunches.

THE PLATOON.

283. The principles of the instruction, as laid down for the detachment, are applicable to the platoon, the word *Platoon*

being substituted for *Detachment*, wherever the latter occurs in the commands.

The platoon is divided into detachments of eight men each, the horse holders being left out, and the men are told off as in No. 187. The gunner is on the right of the platoon; the chief of caisson is the front rank man of the left file. The mounting and dismounting are executed as in Nos. 188 and 201; the gunner taking his place on the right, at the command
FORM RANKS.

ARTICLE SEVENTH.

THE DRIVER.

284. THE value of horses depends greatly upon the management of them, and the care bestowed upon them. A man, therefore, who would be likely to treat them with neglect, cruelty, or harshness, should never be intrusted with the charge of a pair.

The men selected should be thoroughly instructed in *Article Fifth*, and, together with a sufficient number of cannoneers to provide against casualties, be carefully taught in all the duties of drivers. As opportunity occurs, the other cannoneers should be instructed, until all are familiar with at least so much of the duties as are included in the School of the Piece.

Four drivers, with their horses, are united for instruction. The horses are taken in the stalls, which are supposed to be separated by swing bales, or at the pickets; the drivers are in boots and spurs, and sabre belts. When practicable, a well-instructed driver should superintend each man who is taking his first lessons in harnessing.

285. (PLATE 18.) A pair of horses, properly harnessed, should be paraded; the different parts of the harness indicated, and their uses explained to the men individually. DRIVERS' SADDLE; COLLAR: *rim, belly, pad, straps, and billets*; HAMES: *branches, toggles, loops for trace tugs, links for breast straps, rings, trace tugs, trussing straps, hame straps, collar straps*; TRACES: *trace chains, trace loops, trace hooks, belly band, loin strap*; CRUPPER; BREECHING: *breech strap, hip strap, breast strap, loop for pole straps*; VALISE SADDLE: *hook for reins*; VALISE; WHIP: *stock, lash*; LEG GUARD: *body, under strap, leg straps, plate*.

The harness, in its store-room or in the stable, is placed on its peg; the pommel of the saddle next the heel post; the breeching hangs over the cantle; the breast strap and hames over the pommel; the leg guard under the saddle of the near horse; the collars hang over the cantles; each blanket covers its own saddle; the harness bridle, properly secured, hangs on its peg, which should be short, and placed under that of the harness; the whole covered by the harness sack, properly secured.

TO HARNESS.

286. The instructor causes the harness sacks to be taken off, places each man at the heel post, between his horses, and commands:

HARNESS.

5 pauses; 6 motions.

At the command HARNESS, each wheel driver puts on and buckles the collar of his off horse, or passes it, buckled, carefully over the horse's head, arranges and puts on the saddle blanket, then places himself on the left of the saddle.

Two. He seizes the pommel with the left and the cantle with the right hand; slips it off the peg; approaches the near side of the horse, and adjusts the saddle in its proper position, taking care that the blanket does not get deranged nor creased.

THREE. He passes to the front of the horse, pulls the breast strap carefully over his head; adjusts the hames to the collar, connects the lower part of the branches, and tightens the hame straps.

FOUR. He passes to the near side of the horse, disengages the breeching; then moving to the rear, draws it over the horse's haunches; arranges the crupper and loin strap.

FIVE. He sees that the harness is properly arranged, tightens and buckles the girth, and buckles the belly band.

SIX. He bridles the horse, and secures the end of the check rein over the left head post, or to the picket rope.

The near horse is harnessed in the same manner and by the same commands, with this exception :

SIX. At this command, the driver puts his leg guard on the right leg, plate outwards; bridles the horse; looses the check rein of the off horse, and, facing towards them, seizes the reins of the near one with his right, and of the off horse with his left hand, near the bit; backs them into the gangway, facing them towards the door, and takes the position prescribed for leading to the exercise ground.

In harnessing and unharnessing the lead horses, the instructions as laid down for the wheelers apply, with the modifications required by the nature of the harness.

287. Leading to the exercise ground. The driver, with sabre, when worn, hooked up, assumes the position of **STAND TO HORSE**, holding at the same time the coupling rein of his off horse, thrown over the neck of his near one, in his right hand, so as to lead both. At the command **LEAD OUT**, all conduct their horses to the exercise ground, and form in one rank, 4 yards apart, with their horses on their right, the traces trussed up to the hames.

TO COUPLE.

288. At the command **COUPLE**, the driver goes in front of his horses, faces towards them, passes his right hand through the reins of his near horse, and doubles the coupling rein $3\frac{1}{2}$ feet from the bit; with his right hand he passes the doubled part from below through the ring on the right hame of the near horse, inserts the running end of the coupling rein—which is again doubled so as to be readily uncoupled—through this loop, makes it fast by pulling with his left hand, and then resumes the position of **STAND TO HORSE**. When the off horse has a curb bridle, the rein of this bridle is held in the hand without being coupled.

TO MOUNT.

289. The instructor mounts the drivers by the commands and means prescribed for mounting the cannoneer. The reins being adjusted, the driver seizes the whip with his right hand, and fastens it to his wrist by means of the loop; then takes hold

of the coupling rein 20 inches from the hame, closing his hand and pressing his thumb strongly against the second joint of his fore finger, nails downward, the arms falling naturally.

USE OF THE COUPLING REIN AND WHIP.

290. The coupling rein and whip are, for the off horse, what the bridle reins and legs are for the near. If the off horse moves too far forward, he is gently checked by carrying the right hand with the rein nearer to his neck; if he keeps behind, make him feel the whip on his right haunch; if he throws his shoulders in, or haunches out, touch him gently with the whip on his right haunch. The driver should be careful not to use the coupling rein abruptly, especially in halting and reining back, otherwise he will throw the horse suddenly, and too much upon his haunches.

291. **To gather the horses**, the driver raises his right hand and moves it towards the neck of the off horse, at the same time executing for the near horse what is prescribed in No. 160.

TO MARCH.

292. The instructor commands:

1. *Drivers, forward.* 2. **MARCH.**

At the first command, gather the horses. At the command **MARCH**, the driver starts his off horse by lowering his right hand and moving it forward, replacing it as soon as the horse obeys; at the same time he moves the near horse as prescribed for the cannoneer.

293. **To halt.** The instructor commands:

1. *Drivers.* 2. **HALT.**

The near horse is halted as prescribed for the cannoneer; the driver at the same time halts the off horse by gradually carrying the reins towards his neck, raising the right hand so as to make the bit bear. He replaces the hand as soon as the horse obeys.

TO TURN TO THE RIGHT OR TO THE LEFT.

294. The instructor commands :

1. *Drivers, right wheel.*
2. MARCH.
3. HALT.

At the first command, the driver gathers his horses. At the second, he wheels them to the right, making the off horse describe a quadrant of a circle whose radius is 3·25 yards or 10 feet. The off horse moves at the ordinary gait, the near horse quickens his movements to correspond with those of the off horse. At the third command, he halts and holds the horses in hand.

The turn to the left is executed according to the same principles at the commands *Drivers, left wheel*, MARCH, HALT. In this case the near horse, moving at the ordinary gait, describes the quadrant of 5 yards to the left, the off horse quickening his movements to correspond.

295. In all turns and wheels, the *inner* horse describes the arc of a circle whose radius is 3·25 yards; the outer horse increasing his gait, and conforming his movements to those of the inner one.

TO REVERSE.

296. The instructor commands :

1. *Drivers, right (or left) reverse.*
2. MARCH.
3. HALT.

The movement is executed on the same principles as the wheel, the inner horse describing a semicircle of 10 yards, and the outer one of 12 yards, with such an increase of gait as will make his movements correspond with those of the inner horse.

TO OBLIQUE.

297. The instructor commands :

1. *Drivers, right (or left) oblique.*
2. MARCH.
3. HALT.

Which is executed according to the principles of the wheel, observing that the oblique is one-eighth of a circle, and that the

inner horse passes over an arc of 2·5 yards, the radius being 3·25 yards.

TO REIN BACK.

298. The instructor commands :

1. *Drivers, backward.* 2. MARCH. 3. *Drivers, HALT.*

The movement is executed according to the principles prescribed for halting, the driver alternately raising and lowering the wrists as the horses obey, and taking care to move both horses equally. They should at first be backed but a few paces, and the aids prescribed in No. 167 may be used if necessary. At the command HALT, slacken the reins and close the legs; when the horses obey, replace them.

TO DISMOUNT.

299. The instructor commands :

1. *Prepare to dismount.*

2. DISMOUNT.

At the first command, the driver lets go the coupling rein, and hangs the whip from the hook of the valise saddle. He then finishes the movement as prescribed for the cannoneer, and, when it is worn, hooks up the sabre.

TO FILE OFF.

300. The instructor commands :

1. *By the right, (or left,) file off.* 2. MARCH.

At the first command, the driver uncouples by pulling the running end of the coupling rein until it is detached from the hame ring, passing to the front of the horses for the purpose. He then passes the coupling rein over the neck of the near horse, and, holding it with the reins in the right hand, assumes the position of STAND TO HORSE.

At the command MARCH, the drivers file off as already directed for the cannoneer.

TO UNHARNESS.

301. The horses having been returned to their stalls, or the pickets, the off horse is secured by means of the check rein. The instructor then commands:

UNHARNESS.

4 pauses; 5 motions.

At this command, the driver takes off his leg guard, and hangs it up; unbridles the near horse, and puts up the bridle.

TWO. He unbuckles and frees the crupper; slips the breeching over the rump, and places it over the cantle of the saddle, resting the middle of it on the seat.

THREE. He goes to the front, draws the breast straps well forward through their links; loosens the hame straps at the top, disconnects the branches at the bottom; passes the breast strap over the horse's head; laying it, and then the hames, over the pommel of the saddle.

FOUR. He loosens the belly band, and then the girth; strips off the saddle; places it properly on its peg, and covers it with the blanket.

FIVE. He removes and puts up the collar, and secures the horse by his halter.

The off horse is unharnessed in the same manner and by the same commands.

302. Before removing the harness from the horse, it should be wiped clean and dry, if practicable; if not, it should be put in good order at the earliest convenient moment, and covered with its sack.

303. After the drivers have learned to execute properly each motion of harnessing and unharnessing, which should be done under the eye of the instructor, or other non-commissioned officer, or a well-instructed driver, they should be made to execute the movements in two motions. Afterwards, at the simple command **HARNESS**, they will harness both horses of their pairs, taking care to follow the directions in the order laid down in the different numbers.

304. **To harness in two motions.** The instructor commands:

1. *In two motions.*
2. **HARNESS.**

At the command **HARNESS**, they execute the first three motions of No. 286

Two. The drivers execute the last three motions of the same number.

305. **To unharness in two motions.** At the command:

1. *In two motions.*
2. **UNHARNESS,**

the drivers execute the first two motions of No. 301, and at the command **Two**, they execute the remainder.

MARCHING.

306. Not more than eight drivers, with their horses, are united for this part. The men are in spurs and sabres. The horses are harnessed, led out, formed in line, as prescribed in No. 287, and coupled.

The instructor causes the drivers to mount, and again explains the uses of the coupling rein and whip, and the manner of gathering, moving, and halting their horses.

TO BREAK INTO COLUMN TO THE FRONT.

307. The instructor commands:

1. *Drivers, from the right, front into column.*
2. **MARCH.**

(PLATE 23, Fig. 1.) At the first command, the driver on the right gathers his horses; and at the command **MARCH**, moves directly to the front. As soon as he moves, the next driver gathers his horses; and so soon as the haunches of the first pair are on a line with the heads of his own, he moves forward 5 yards, obliques to the right, and again to the left, in time to enable him to enter the column. He then follows in the tracks of the pair that precedes him, preserving the distance of 2 yards from head to croup. Each of the other drivers executes the movement in succession, as prescribed for the second.

The column is formed from the left on the same principles, the commands being,

1. *Drivers, from the left, front into column.* 2. MARCH.

CHANGE OF DIRECTION IN COLUMN.

308. The drivers marching in column, to execute a change of direction to the right or left, the instructor commands :

1. *Head of column, right (or left) wheel.*
2. MARCH. 3. FORWARD.

At the first command, the leading driver executes the wheel, and moves directly to his front at the command FORWARD. He is followed by the other drivers, who wheel in succession on the same ground.

A change of direction, diagonally, is executed at the command :

1. *Head of column, right (or left) half-wheel.*
2. MARCH. 3. FORWARD.

The leading driver making a half-wheel, and moving to the front.

TO HALT THE COLUMN.

309. The instructor commands :

1. *Column.* 2. HALT.

At the first command, the driver gathers his horses; at the second, he halts.

To resume the march in column, the commands are :

1. *Column forward.* 2. MARCH.

TO OBLIQUE IN COLUMN.

310. The instructor commands :

1. *Drivers, right (or left) oblique.* 2. MARCH.

Which is executed as in No. 297, except that when the drivers

have made a half-wheel, they move directly to the front, until the command

FORWARD

is given, when they resume the primitive direction.

Whilst obliquing, the drivers may be halted by the command *Drivers*, HALT. To resume the march in the oblique direction, the command is given :

1. *Drivers*. 2. MARCH.

The drivers will keep their relative position, so that at the command FORWARD, they will move accurately in column in the primitive direction.

TO FORM LINE.

311. **To the front.** The column being in march, or at a halt, the instructor commands :

1. *Drivers, forward into line, right (or left) oblique.*

2. MARCH. 3. *Left (or right) dress.* 4. FRONT.

At the command MARCH, the leading driver advances 5 yards, and halts. The other drivers oblique to the right (or left) until opposite their positions in line, then move forward and form at the proper distance, on the right (or left) of the preceding drivers, and dress.

312. **To the right or left.** The column being in march or at a halt, the instructor commands :

1. *Drivers, right (or left) into line, wheel.*

2. MARCH. 3. HALT.

Each driver wheels to the right, (or left,) as prescribed in No. 294, and halts at the command, which should be given when the horses are in the new direction. The instructor then aligns them.

313. **On the right or left.** The instructor commands :

1. *Drivers, on the right (or left) into line.* 2. MARCH.

3. HALT. 4. *Right (or left) dress.* 5. FRONT.

At the command MARCH, the leading driver wheels to the

right, moves forward, and halts at the command of the instructor, which should be given when he has unmasked the column.

The other drivers continue to advance, wheel to the right in succession, so as to take their places in line on the left of the preceding one, and dress.

The instructor gives the command *Right-DRESS*, as soon as the first driver halts. As soon as the last driver is aligned, he commands **FRONT**.

TO ADVANCE IN LINE.

314. The instructor commands:

1. *Drivers, forward.* 2. **MARCH.** 3. *Guide RIGHT (or LEFT.)*

At the first command, gather the horses, at the second move forward, preserving the intervals, and dressing on the guide.

To halt. When marching in line, the instructor commands:

1. *Drivers.* 2. **HALT.**

TO OBLIQUE IN LINE.

315. The instructor commands:

1. *Drivers, right (or left) oblique.* 2. **MARCH.**

Which is executed in the same manner as the oblique in column, except that the drivers, dressing towards the right, (or left,) and moving in the same direction, keep in such position with respect to each other that, at the command **FORWARD**, they will move to the front in a line parallel to the primitive one.

TO MARCH TO A FLANK.

316. **The drivers being in line, in march, or at a halt, the instructor commands:**

1. *Drivers, by the right (or left) flank.*
2. **MARCH.** 3. **FORWARD.**

Each driver wheels to the right (or left) at the command **MARCH**, and at the command **FORWARD**, moves to the front.

The drivers being in column, the commands are :

1. *Column by the right (or left) flank.* 2. MARCH.
3. FORWARD. 4. *Guide* RIGHT (OR LEFT.)

TO REVERSE IN MARCHING.

317. The drivers being in line, the instructor commands :

1. *Drivers, right (or left) reverse.* 2. MARCH.
3. FORWARD. 4. *Guide* RIGHT (OR LEFT.)

The movement is executed as prescribed in No. 296, except that at the third and fourth commands the drivers move to the front, dressing on the guide.

The drivers being in column, the commands are :

1. *Drivers, right (or left) reverse.* 2. MARCH.
3. *Column*—FORWARD.

CHANGE OF GAIT.

318. When the drivers have become accustomed to the management of a pair of horses at a walk, they will be practised at a trot, and occasionally at a gallop.

To trot, the instructor commands :

1. *Trot.* 2. MARCH.

At the first command, the driver gathers his horses. At the command MARCH, he takes the trot gradually, using for the near horse the means prescribed for the cannoneer, at the same time advancing the coupling rein with the right hand. If the off horse does not obey this, the whip may be threatened, and, if necessary, used. When the horse obeys, replace the hand.

At the command *Trot out*—MARCH, the horses are urged to a rapid trot, and the gait maintained if necessary by the whip and spur.

At the command *Gallop*—MARCH, they are urged to the gallop, which gait is maintained until ordered to be changed.

To pass from the gallop to the trot, the commands are :

- Trot* MARCH.

To pass from the *trot out* to the *trot*, the commands are :

Slow trot, MARCH.

To pass to a *walk*, the commands are :

Walk, MARCH.

319. To move at the rapid gaits from a halt, the commands *Trot*, etc. should be added to the first commands, so as to immediately precede those of execution. All *changes* of gait should be made gradually.

TO PASS FROM THE REAR TO THE HEAD OF THE COLUMN AND THE REVERSE.

320. To accustom the horses to leave and enter the column, and to ensure the proper control of their motions, the instructor will occasionally cause the drivers to pass from the rear to the head of the column and the reverse. To execute this movement, he commands :

1. *Rear driver to head of column.* 2. MARCH.

At the first command, the rear driver gathers his horses ; at the second, he obliques to the right until out of the column, moves forward, and takes his position as head of the column by obliquing to the left. The movement is executed at a *trot* when the column is moving at a walk, and at a *trot out* or *gallop* when it is moving at a trot, the driver resuming the primitive gait upon entering the column.

Each driver will be directed in succession to pass to the head of the column.

To pass from the head to the rear of the column, the instructor commands :

1. *Leading driver to rear of column.* 2. MARCH.

At the first command, the leading driver gathers his horses. At the command MARCH, he reverses to the right, moves to the rear, and reverses again to the right in time to re-enter the column at his proper distance. The movement is executed at the gait of the column.

321. The drivers are rested as prescribed for the cannoneers, No. 184 and No. 185.

PART IV.

SCHOOL OF THE SECTION.

GENERAL PRINCIPLES.

322. **THE** object of this school is the instruction of the section in all its duties preparatory to its entering the battery of manœuvre. This instruction is given by the chief of section under the direction of the captain.

Each section consists of two pieces with their caissons, and the men, horses, and materiel required for their service.

The chiefs of sections are at all times responsible to their captain for the instruction, good appearance, and serviceable condition of everything belonging or attached to their sections.

The chiefs of pieces are in like manner responsible to the chiefs of sections for their pieces and everything pertaining to them.

The gunner is responsible to the chief of his piece for the good order of the gun, its carriage, limber, and equipments, and for the instruction of the cannoneers in their duties at the piece. He will hold each of them responsible for the condition of the equipments belonging to his number.

The chief of caisson (No. 8) is responsible to the chief of the piece for the caisson, its equipments, and the condition of the ammunition and other supplies belonging to it.

The drivers are directly responsible, each for his horses, harness, and equipments, to the chief of the piece.

It is the duty of both drivers and cannoneers to report at once to chiefs of pieces, any injury to their horses, or materiel, or any deficiency in the equipments. As soon as such injury or deficiency becomes known to the chiefs of pieces, they will at once take the necessary steps to remedy it, reporting the facts to their chiefs of section.

ARTICLE FIRST.

EXERCISE OF SEVERAL DETACHMENTS.

Formation of Detachments and Posts of Officers.

323. THE gun detachments, properly told off, are drawn up in line corresponding to the positions of their pieces in park, and touching each other. The cannoneers composing each of them retain their numbers, and are kept in a fixed relation to each other when in rank and file formation; but the detachment itself constitutes *a unit*. No notice is taken of inversions; the actual right and left detachments being the right and left of the line, which may be formed from column by throwing the rear detachments either to the right or left of the leading one.

324. When the detachments are *in line*, the gunners are posted on the right of the front rank; when *in column*, they are 1 yard in front of the centre; and when *faced by flank*, they are in their proper positions in the front rank. When the chiefs of pieces are present, they act as gunners, the latter taking their places 1 yard in rear of the right files of their respective detachments, and resuming their positions when the chiefs of pieces are out of the ranks.

The officers, when present, are posted as follows:—**Chiefs of sections.** *In line*, 2 yards in front. *In column of detachments*, 2 yards outside the wheeling flank. *By flank*, 2 yards from the front rank, in all cases opposite the centres of their sections, except that when faced by flank the chief of the leading section marches at the side of the leading man. **The chief of caissons.** *In line*, 4 yards in rear of the centre. *In column*, or *by flank*, 4 yards from the centre of the column, on the side opposite the chiefs of sections.

ALIGNMENTS.

325. The detachments are aligned by the instructor, as directed in No. 35, at the commands :

1. *Right (or left) DRESS.*
2. FRONT.

TO OPEN AND CLOSE THE RANKS.

326. To open the ranks, the instructor commands :

1. *To the rear, open order.*
2. MARCH.
3. *Right-DRESS.*
4. FRONT.

At the first command, the gunners step back briskly 5 yards, and halt opposite their places in line. The remainder of the movement is executed as directed in No. 57.

At the command FRONT, the gunners resume their positions in the front rank.

To close the ranks, the instructor commands :

1. *Close order.*
2. MARCH.

At the command MARCH, the rear rank closes on the front.

TO BREAK INTO COLUMN TO THE RIGHT OR LEFT.

327. The instructor commands :

1. *By detachment, Right-WHEEL.*
2. MARCH.
3. HALT.

At the first command, the gunners step briskly 1 yard to the front of the centres of their detachments, face towards them, and repeat the commands in succession after the instructor. They are executed as prescribed in No. 45.

As soon as each detachment is halted, its gunner dresses it to the left, the guides covering each other at distances equal to the front of a detachment, and then takes his place in column.

The line is broken into column to the left on the same principles.

MARCH IN COLUMN.

328. To put the column in motion, the instructor commands :

1. *Column—FORWARD.*
2. MARCH.
3. *Guide left (or right.)*

The commands FORWARD, MARCH, and *Guide left*, are repeated by the gunners. The guide of each detachment marches in the steps of the one preceding him, keeping his proper distance accurately. The leading guide marches steadily to the front, in the direction given by the instructor.

329. When the instructor, after wheeling the detachments into column, wishes to put them in motion without halting, instead of commanding HALT, as prescribed in No. 327, he commands:

3. *Column*, FORWARD. 4. *Guide left* (or *right*.)

The gunner repeats the command FORWARD, and that for the guide.

TO HALT THE COLUMN.

330. The instructor commands:

Column—HALT.

The command HALT is repeated by the gunners.

CHANGE OF DIRECTION IN COLUMN.

331. The column marching, the instructor commands:

HEAD OF COLUMN TO THE LEFT.

At this command, the gunner of the leading detachment wheels it to the left, and commands FORWARD as the movement is completed. The other detachments wheel in succession on the same ground as the first, and at the same commands from the gunners, the men taking care not to commence the wheel until the command is given.

To change direction to the right, the movement is executed on the same principles.

TO MARCH BY A FLANK WHEN IN COLUMN.

332. The column marching, the instructor commands:

1. *Column by the right* (or *left*) *flank*. 2. MARCH.

3. FORWARD. 4. *Guide left* (or *right*.)

At the command *by the right flank*, MARCH, repeated by the

gunners, the detachments face and continue the march. The gunners take their places at the sides of their leading files, dress on the guides, and preserve the intervals. The officers face with the detachments, and maintain their relative positions.

333. To resume the primitive direction, the instructor commands :

1. *By the left (or right) flank.* 2. MARCH.
3. *Column forward.* 4. *Guide right (or left.)*

At the command MARCH, the detachments face as directed. The gunners repeat the commands, and resume their places in column.

OBLIQUE MARCH IN COLUMN.

334. The column marching, the instructor commands :

1. *Cannoneers, left (or right) oblique.* 2. MARCH.

The gunners repeat the commands in succession after the instructor, and each detachment obliques as prescribed in No. 54.

The guide of the front rank of the leading detachment is the guide of the column. The other guides move in the same direction and keep on a line with him, so that at the command FORWARD, they will cover each other accurately at proper distances.

The primitive direction is resumed at the commands :

1. FORWARD. 2. *Guide left (or right.)*

Given by the instructor, and repeated by the gunners.

BEING IN COLUMN TO FORM LINE.

335. To the front, gaining ground to the left. The column being in march, or at a halt, the instructor commands :

1. *Forward into line, left oblique.* 2. MARCH.
3. *Guide right.* 4. FRONT.

At the first command, the leading gunner commands FORWARD, and the others, *Cannoneers, left oblique.* At the command MARCH, repeated by the gunners, the leading detachment advances 18 yards, and is halted by the gunner, who commands *Right-dress*, and takes his place in line. The other detachments oblique

until each is opposite its proper position, when its gunner commands FORWARD; *Guide right*; halts it abreast of the leading detachment, commands *Right-DRESS*, and takes his place in line.

The instructor aligns the detachments and commands FRONT.

336. **To the front, gaining ground to the right.** The line is formed on the right of the leading detachment, on the same principles, at the commands:

1. *Forward into line, right oblique.* 2. MARCH.
3. *Guide left.* 4. FRONT.

The gunners oblique their detachments to the right; halt them abreast of the leading detachment; command *Left-DRESS*, and take their positions in line, which is on the right of their respective detachments.

337. **On the right or left.** The instructor commands:

1. *On right into line.* 2. MARCH.
3. *Guide right.* 4. FRONT.

At the first command, the leading gunner commands: *Right wheel*, and at the second, which he repeats, wheels his detachment to the right, marches it forward until it unmask the column, halts it, commands *Right-DRESS*, and takes his place in line. The other gunners repeat the commands for the guide, wheel their detachments to the right as soon as they are opposite the left of the preceding one, move them forward, halt them on the line, command *Right-DRESS*, and take their places in line.

As soon as the detachments are properly aligned, the instructor commands FRONT.

The detachments are formed in line on the left according to the same principles; at the commands:

1. *On left into line.* 2. MARCH.
3. *Guide left.* 4. FRONT,

the gunners command *Left-DRESS* as soon as their detachments halt, and take their places in line on the right.

338. **To the right or left.** The instructor commands:

1. *Right (or left) into line, wheel.* 2. MARCH.
3. HALT. 4. *Left (or right) DRESS.*

The commands *Right (or left) wheel*, MARCH, and HALT, are repeated by the gunners, who take their places in both cases on the right as soon as the movement is executed. The instructor then aligns the detachments by the commands: *Right (or left) DRESS, FRONT.*

339. In all formations and changes of front in line the officers promptly take their proper positions, passing, if necessary, through the intervals during the execution of the movements.

TO FORM LINE ADVANCING.

340. The column marching at a walk, to form the detachments in line gaining ground to the left, and to continue the march, the instructor commands:

1. *Form line advancing—left oblique—double quick.*
2. MARCH. 3. *Guide right.*

The leading gunner repeats the command for the guide, and his detachment continues the march; the other gunners command *Left oblique—double quick*, and MARCH, in succession after the instructor. As soon as each detachment has obliqued sufficiently, its gunner gives the command FORWARD—*guide right*, when it moves directly to the front, and on arriving upon the line resumes the ordinary step; the officers and gunners taking their positions in line.

The movement is performed gaining ground to the right on the same principles, the commands of the instructor being:

1. *Form line advancing—right oblique—double quick*
2. MARCH. 3. *Guide left.*

TO ADVANCE IN LINE.

341. The instructor commands:

1. *Section, (or —,) forward.* 2. MARCH.
3. *Guide left (or right.)*

Which are executed according to the principles laid down in No. 50, the gunners remaining in their positions in line, which are always on the right of their detachments.

To halt, the instructor commands:

Section, (or —,) HALT.

OBLIQUE IN LINE.

342. This movement is executed according to the principles prescribed in No. 54. For a detachment the commands are:

1. *Cannoneers, left (or right) oblique.* 2. MARCH.

TO CHANGE DIRECTION IN LINE.

343. The movements are according to the principles laid down in Nos. 45, 46, and 47; the commands are:

1. *Section, (or —,) left (or right) wheel (or reverse.)*

2. MARCH. 3. HALT.

Or, 3. FORWARD. 4. *Guide left (or right.)*

TO MARCH BY A FLANK WHEN IN LINE.

344. To the right or left. The line marching, the instructor commands:

1. *Section, (or —,) by the right (or left) flank.*

2. MARCH. 3. FORWARD.

At the command MARCH, the detachments face and continue the march; the gunners remaining in the front rank. The chief of the leading section places himself at the side of the leading gunner or file.

If the line is at a halt, it is first faced to the right, or left, by the command from the instructor:

Section, (or —,) right (or left) face.

And then put in motion by the command:

1. *Column, forward.* 2. MARCH.

The chief of the leading section takes his place at the side of the leading gunner, or file, at the first command.

345. The march in line in the primitive direction is resumed at the command:

1. *Column, by the left (or right) flank.* 2. MARCH.

3. FORWARD. 4. *Guide right (or left.)*

346. **To the front.** The instructor commands :

1. *Section, (or —,) by the right flank by file left, (or by the left flank by file right.)* 2. MARCH. 3. FORWARD.

The movement is executed as prescribed in No. 52 for a detachment.

TO CHANGE DIRECTION WHEN FACED BY A FLANK.

347. The movement is executed on the principles laid down in Nos. 39 and 50 for a single detachment.

MARCHING BY A FLANK TO FORM COLUMN OF DETACHMENTS.

348. The instructor commands :

FORM DETACHMENTS.

At this command, each gunner forms his detachment into line, as prescribed in No. 53. The instructor then gives the command for the guide, which is repeated by the gunners.

TO PASS FROM THE MARCH IN COLUMN TO THE MARCH BY FLANK.

349. The instructor commands :

1. *By the right flank, by file left.*
2. MARCH. 3. FORWARD.

At the command MARCH, repeated by the gunners, each detachment faces to the right, and then turns to the left, the gunners taking their posts in the ranks.

The column is marched by a flank, with the left in front, on the same principles, at the command :

1. *By the left flank, by file left.*
2. MARCH. 3. FORWARD.

The gunners taking their positions next to No. 2 in the ranks.

MARCHING BY FLANK TO FORM LINE.

350. Detachments are first formed as prescribed in No. 348,

after which they are formed in line, as prescribed in No. 335, and following.

TO FORM THE LINE OR COLUMN FACED IN THE OPPOSITE DIRECTION.

351. The line or column being in march or at a halt, the instructor commands :

1. *Detachments, right (or left) reverse.* 2. MARCH.
3. HALT. 4. *Left (or right) dress.* 5. FRONT.

The commands are repeated by the gunners, and each detachment executes the reverse, as prescribed in No. 46.

If the detachments are in column, the officers do not change sides; but if they are in line, the officers pass through one of the intervals during the execution of the movements, so as to take their proper positions in line.

If the instructor wishes the detachments to move forward in the new direction, instead of the command HALT, etc., he commands FORWARD, or *column* FORWARD, as the reverse is about being completed, and adds the command for the guide.

TO MARCH TO THE REAR.

352. The detachments being in line or in column, to gain ground to the rear, the same commands are used as in No. 55, the command for the guide being always given after that of execution.

In this case the officers face to the rear at the proper commands, but do not pass through the line to take position.

POSTING THE DETACHMENTS WITH THEIR PIECES.

353. The detachments are marched to the battery either in column or in line, as circumstances may require. If approaching in column, in a direction parallel to the battery, the instructor, when near it, commands :

DETACHMENTS, OPPOSITE YOUR PIECES.

Each detachment is halted by its gunner when opposite its piece, and wheeled into line.

Approaching from the front or rear, the detachments are formed in line facing the battery, in the same order as their pieces, and the instructor commands:

DETACHMENTS, OPPOSITE YOUR PIECES.

Each is wheeled or faced in the proper direction by its gunner, marched opposite to its piece, and formed in line, as directed in No. 120.

The cannoneers are then posted and exercised together at their duties in the manual of the piece, and mechanical manœuvres, under the direction of the officer commanding as instructor.

EXECUTION OF THE MOVEMENTS AT THE DOUBLE QUICK.

354. The movements directed in the exercise for several detachments, may be made in double quick time, and the ordinary time resumed according to the principles of No. 61.

EXERCISE OF THE SECTION AND OF THE COMPANY.

355. When the section, division, or company is paraded, the principles laid down in the Article **Exercise of Several Detachments** apply. The commands are modified to suit the circumstances, the terms *section*, *company*, *etc.*, being used to designate the line.

In the exercises, the platoon or sections may be made the *unit* at the pleasure of the instructor. The movements are conducted on the same principles as when the detachment is the unit, with the modifications in the words of command rendered necessary by the circumstances.

In *line* or in *column of sections*, either when marching or at a halt, to form faced in the opposite direction, the reverse may be executed by platoon or by section. In column of platoons the reverse should be executed by platoon. It may be executed by detachment in all cases, but this mode of changing the front should not be resorted to except in cases of necessity, or when the gun detachments only are paraded.

ARTICLE SECOND.

EXERCISE OF SEVERAL DETACHMENTS—HORSE
ARTILLERY.*Formation of Detachments and Posts of Officers, etc.*

356. THE detachments, properly told off, are drawn up in line corresponding to the position of their pieces in park, and touching each other. The cannoneers, as in dismounted detachments, retain their numbers and relative positions, but each detachment constitutes a unit, and no notice is taken of inversions in the manœuvres. When the chiefs of sections are not present, there is an assistant instructor, who is mounted.

357. In line or column of detachments, the gunners are on the right of their respective detachments in the front rank. Each constitutes a file, unless the chiefs of pieces are present, in which case the latter take their places on the right of the front rank, the gunners covering them in the rear rank and completing the files.

358. The officers, when two or more sections are united, are posted as directed for dismounted detachments, except that in column of detachments the chief of the leading section is 2 yards in front of the centre of the column.

The assistant instructor is posted: *In line*, 4 yards in front of the centre of the detachments. *In column*, 2 yards in front of the centre of the leading detachment. *By flank*, at the side of the leading file.

TO MOUNT AND DISMOUNT.

359. (PLATE 22, Fig. 1.) The detachments are mounted and dismounted as in Nos. 232 and 233.

ALIGNMENTS.

360. The detachments are aligned as in No. 238.

TO OPEN AND CLOSE THE RANKS.

361. The ranks are opened and closed as in Nos. 242 and 243.

TO BREAK INTO COLUMN.

362. **To the front.** The detachments being in line at a halt, to break from the right, the instructor commands :

1. *By detachment from the right—front into column.*
2. MARCH. 3. GUIDE left.

At the command MARCH, the right detachment moves to the front, the assistant instructor taking his place 2 yards in front of its centre. The other detachments gather their horses and move off in succession, each as soon as the haunches of the horse of the rear rank of the detachment on its right are on a line with the heads of its own front rank horses. They move directly to the front 6 yards, and then oblique to the right, as prescribed in No. 279, until they intersect the column, when, by a left oblique, they enter it, and resume the dress towards the guide. The gait is so regulated that upon entering the column there should be 2 yards distance between the detachments.

The detachments are broken into column from the left, according to the same principles. The commands are :

1. *By detachment from the left—front into column.*
2. MARCH. 3. Guide right.

363. If the detachments are marching in line, the commands of the instructor are :

1. *By the right, (or left,) break into detachments.*
2. MARCH. 3. Guide left (or right.)

At the command MARCH, all the detachments except the right (or left) halt, if they are marching at a walk ; or walk, if they are marching at a trot, and the movement is completed as in No. 362,

each detachment resuming the original gait, to commence the movement.

364. **To the right or left.** The detachment being in line, at a halt or in march, the instructor commands :

1. *By detachment, right (or left) wheel.* 2. **MARCH.**
3. **FORWARD.** 4. *Guide LEFT (OR RIGHT.)*

At the command **MARCH**, each detachment executes the wheel as in No. 275, and moves to the front at the command **FORWARD**, so regulating the gait that there shall be a distance of 2 yards between the detachments.

MARCH IN COLUMN.

365. The guide of the leading detachment marches steadily to the front, and in such manner as to keep his detachment 2 yards behind the assistant instructor. The other guides follow accurately the leading one at such distances that there shall be a space of 2 yards between the detachments. If the distances are lost, they will be regained gradually.

TO HALT THE COLUMN.

366. The instructor commands :

Column—HALT.

To resume the march in column, the commands are :

1. *Column, forward.* 2. **MARCH.**
3. *Guide LEFT (OR RIGHT.)*

CHANGE OF DIRECTION IN COLUMN.

367. The column marching, the instructor commands :

Head of column to the right (or left.)

The assistant instructor commands :

1. *Right (or left) wheel.* 2. **MARCH.** 3. **FORWARD.**

The leading detachment wheels to the right at the command **MARCH**, and, at the command **FORWARD**, moves to its front; the

other detachments wheel, on reaching the same ground, without further commands.

The assistant instructor should give the first command in time to command MARCH, when the detachment is 2 yards from the turning point, as that distance to the front is gained in wheeling.

An oblique change of direction is executed on the same principles, at the commands from the instructor :

Head of column, right (or left) half-wheel.

OBLIQUE MARCH IN COLUMN.

368. The column marching, the instructor commands :

1. *Cannoneers, right (or left) oblique.*
2. MARCH.

At the command MARCH, each detachment obliques, as prescribed in No. 279.

The guide of the leading detachment is the guide of the column. The other guides move in the same direction, and keep on a line with him, so that at the command FORWARD, they will cover each other accurately at proper distances.

The primitive direction is resumed at the commands :

1. FORWARD.
2. *Guide left (or right.)*

THE COLUMN MARCHING TO FACE IT IN THE OPPOSITE DIRECTION.

369. The column being in march, the instructor commands :

1. *Detachments, right (or left) reverse.*
2. MARCH.
3. *Column, FORWARD.*
4. *Guide right (or left.)*

At the command MARCH, each detachment executes the reverse at the gait at which it is marching, and the assistant instructor passes to the head of the column.

At the command FORWARD, the column marches to its front.

If the chiefs of sections are present, they do not change to the other side of the column, but each executes the reverse on his own ground. The chief of the section which has become the leading one takes his place at the head of the column, the one

who has been at the head of the column returning to his proper place on the flank.

BEING IN COLUMN TO FORM LINE.

370. **To the front, gaining ground to the left.** The column being in march or at a halt, the instructor commands :

1. *Forward into line, left oblique.* 2. MARCH.
3. *Guide right.* 4. FRONT.

At the command MARCH, the leading detachment advances 14 yards, and is halted by the assistant instructor, who then commands *Right-DRESS*, and takes his place in line.

The other detachments oblique to the left until opposite their places in line, when they move to the front, dressing to the right, and form in succession on the left of the preceding detachment.

371. **To the front, gaining ground to the right.** The line is formed on the same principles, at the commands from the instructor :

1. *Forward into line, right oblique.* 2. MARCH.
3. *Guide left.* 4. FRONT.

The detachments, obliquing to the right, form in succession on the right of the leading detachment, and dress to the left.

372. **On the right (or left.)** Being in march, the instructor commands :

1. *On the right into line.* 2. MARCH.
3. *Guide right.* 4. FRONT.

At the command MARCH, the leading detachment wheels to the right, advances until it has unmasked the column, and is halted by the assistant instructor, who then commands *Right-DRESS*, and takes his place in line.

The other detachments continue the march, dressing to the right; wheel in succession opposite their proper positions, on the left of the first, advance to the line, halt, and dress to the right.

The detachments are formed in line *on the left* according to the same principles, the commands being :

1. *On the left into line.* 2. MARCH.
3. *Guide left.* 4. FRONT.

373. **To the right or left.** The detachments being in march, the instructor commands :

1. *Right into line, wheel.* 2. MARCH.
3. HALT. 4. *Left-DRESS.* 5. FRONT.

At the command MARCH, the leading detachment wheels to the right. When it has unmasked the column, the assistant instructor commands HALT, *Left-DRESS*, and takes his place in line.

The other detachments wheel in succession opposite their proper positions, advance and take their places in line, on the right of the first, dressing to the left.

In all the formations into line the instructor gives the commands for the guide, immediately after the command MARCH, and the command FRONT as soon as the last detachment is aligned.

TO FORM LINE ADVANCING.

374. The column marching at a walk, to form the detachments in line gaining ground to the left, and to continue the march, the instructor commands :

1. *Form line advancing—left oblique—trot.*
2. MARCH. 3. *Guide right.*

At the command MARCH, the leading detachment continues to advance at a walk. The other detachments oblique at a trot until opposite their positions, and then move forward, and form in succession on the left of the first, resuming the walk as they reach the line, and dressing to the right.

The assistant instructor repeats the command for the guide, and takes his position in line.

When the column is marching *at a trot*, the movement is executed on the same principles; but the instructor does not add *trot* to the first command. The assistant instructor gives the commands *walk* and MARCH to the leading detachment in succession, after the first and second commands of the instructor; repeats that for the guide; and takes his place in line.

The movement is executed so as to gain ground to the right, on the same principles.

TO ADVANCE IN LINE.

375. The instructor commands:

1. *Section, (or —,) forward.*
2. MARCH.
3. *Guide right (or left.)*

These commands are executed, as in No. 262, at the different gaits, the assistant instructor keeping his position in line.

The guide should never put himself in motion suddenly, and should pass gradually from a slow to a quick gait, or from a quick to a slow gait. He should move carefully and steadily in the direction indicated, taking up points in advance by which to regulate his march. These points should be in a line perpendicular to the front of the detachments.

OBLIQUE IN LINE.

376. The detachment being in line, to cause it to gain ground to the front and towards one of its flanks, without a change of front, the instructor commands:

1. *Cannoneers, right (or left) oblique.*
2. MARCH.

These commands are executed as prescribed in No. 376 for a single detachment. When sufficient distance has been gained towards the flank, the instructor commands FORWARD.

TO CHANGE DIRECTION IN LINE.

377. The detachments being in march, or at a halt, the instructor commands:

1. *Section, (or —,) right wheel (or reverse, etc.)*
2. MARCH.
3. FORWARD.

These commands are executed as prescribed in Nos. 275, 276, and 277, for a single detachment, except that the radius of the arc described by the pivot is about eight yards, so that the arc in the wheel is twelve yards; in the reverse, twenty-four yards; and in the half-wheel, six yards.

MARCHING IN LINE TO MARCH IN THE OPPOSITE DIRECTION.

378. The instructor commands :

1. *Detachments, right (or left) reverse.* 2. MARCH.
3. FORWARD. 4. *Guide right (or left.)*

At the command MARCH, each detachment executes the reverse without confusion, and as it is about being completed, the instructor commands FORWARD, and adds the command for the guide.

When the detachment presents a front of less than five men, this movement will be difficult or impossible to execute. In such case the instructor will cause the reverse to be executed by *section* instead of by *detachment*. It would generally be better to execute the change of front by section.

The officers pass through the line during the execution of the movement, and take their proper positions.

TO MARCH BY FILE.

379. The detachments being in line are marched by file.

To the front. (PLATE 22.) According to the principles and by the commands prescribed in Nos. 245 and 247.

To the right or left. (PLATE 19, Fig. 4.) According to the principles and by the commands prescribed in Nos. 246 and 247.

CHANGE OF DIRECTION IN FILE.

380. The detachments marching by file, the direction is changed by the commands and means prescribed in No. 249.

TO HALT AND TO MOVE OFF.

381. The column is halted and moved forward again as prescribed in No. 250.

OBLIQUE IN FILE.

382. The oblique is executed at the commands and by the means prescribed in Nos. 251 and 252 for a single detachment.

To mount and dismount in two ranks.

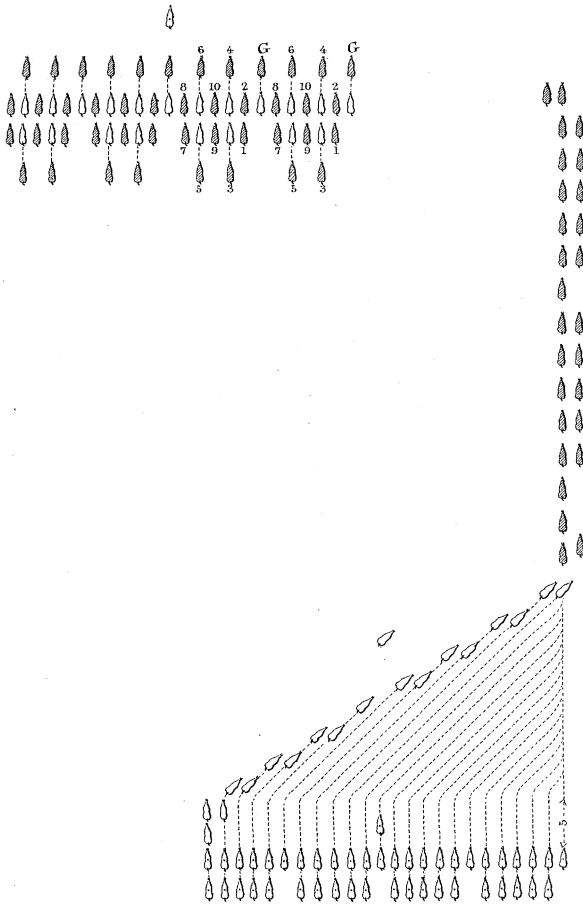

To march in double files.

CHANGES OF GAIT.

383. The gaits are changed as prescribed in Nos. 281 and 282.

TO BREAK INTO SINGLE FILE.

384. When the column is marching in double files, it may be formed in single files, as prescribed in No. 253.

The detachment being in line may be moved to the front in single file by the commands and means prescribed in No. 254.

TO FORM DOUBLE FILES.

385. The column is formed in double files as prescribed in No. 255.

TO FORM LINE.

386. When the detachments are marching by flank, the line may be formed as prescribed in Nos. 256, 257, 258, and 259, provided it does not change the relative positions of the cannoneers in the detachments.

387. The foregoing movements are executed by the detachments as if they constituted a single detachment.

When marching by a flank, the line may be formed directly as in No. 386, but it would always be better first to form the column of detachments, and afterwards form this column into line by the means prescribed in No. 370, and following.

MARCHING BY A FLANK TO FORM COLUMN OF DETACHMENTS.

388. The instructor commands :

1. *Form detachments.*

2. MARCH. 3. *Guide right (or left.)*

At the first command, all the detachments except the leading one halt, if they are marching at a walk, or walk if they are marching at a trot.

At the command MARCH, the leading detachment forms as directed in No. 256. The other detachments take up the move-

ment in succession, at the original gait, as soon as the cannoneers of the one in front of them begin the oblique. The gait is regulated so as to take their proper distances promptly, but without confusion.

The instructor gives the command for the guide as soon as the leading detachment is formed.

IN COLUMN OF DETACHMENTS TO MARCH BY FILE.

389. The instructor commands :

1. *Double files, from the right (or left.)*

2. MARCH.

At the command MARCH, all the detachments except the leading one halt, if the column is marching at a walk, or walk if it is marching at a trot. The leading detachment forms in double files as in No. 247, the others taking up the movement in succession at the original gait, and closing to the proper distances.

POSTING THE DETACHMENTS WITH THEIR PIECES.

390. The detachments are marched to the park, either in column or line, and posted at their pieces as directed in No. 353, or, should it be more convenient, they may be marched each in rear of the teams belonging to its piece.

When the nature of the ground requires, the detachments are halted outside the park and marched to their posts successively as the pieces file out.

The position of the detachment is habitually in rear of its piece, but positions may be changed by the means laid down in No. 122.

ARTICLE THIRD.

EXERCISE OF SEVERAL PIECES.

The Team.

391. THE team consists of two or more pairs of horses, with their drivers.

In manœuvring with empty ammunition chests, two pairs are considered to be sufficient. With full chests, or for the road, three pairs are required, and for the heavier classes of field guns four pairs. The instruction is given for three pairs; they are denominated the *lead*, *middle*, and *wheel horses*.

At first not more than four teams should be united; but as soon as the drivers are sufficiently instructed, the number may be increased to six or eight.

The instructor is mounted. He is aided by one assistant, also mounted, to every two teams, who will see that all the movements are properly performed by the teams under their charge.

In the movements, the instructor goes wherever his presence may be necessary. *In line*, the assistants take post each on a line with the lead drivers, and midway between their teams. *In column*, they are 4 yards from the left flank, and opposite the centres of their teams, with the exception of the assistant, whose teams are at the head of the column, who takes post on the left of the leading driver.

ARRANGEMENT OF THE TEAMS.

392. The drivers, dismounted, are in one rank, each preserving an interval of 2 feet between his off horse and the near horse of the man on his right. The leading horses are on the

right, and the wheel horses on the left in each team; this rule is invariable.

When the pieces are parked in more than one line, the teams of the second line are placed, each on the left of the corresponding team in the first; the teams of the third line are placed in like manner on the left of the teams of the second, and so on; the teams of the same file of carriages being always drawn up in the same line, from the right to the left.

The teams may be drawn up in two or more lines if the nature of the ground requires it.

The drivers couple their horses without command, and the instructor, after aligning them, causes them to mount as prescribed, and commands:

1. *Right-dress.*

2. *FRONT.*

The drivers align themselves, each preserving an interval of 2 feet between his off horse and the near horse of the driver on his right.

The assistant instructors are 4 yards in rear of the centres of their teams.

TO BREAK INTO COLUMN.

393. The instructor commands:

1. *By team from the right-front into column.* 2. *MARCH.*

(PLATE 23, Fig. 1.) At the command *MARCH*, the lead driver on the right, and all the others in succession, execute the movement explained in No. 307, each driver regulating the obliquity of his march according to his distance from the right.

The column is broken from the left at the command:

1. *By team from the left-front into column.* 2. *MARCH.*

(PLATE 23, Fig. 2.) At the command *MARCH*, the lead driver of the left team moves to the front and is followed by the other drivers of this team, who break successively, as has been prescribed; the lead driver of the second team from the left commences his movement in time to get his proper distance in the column and is followed in succession by the other drivers of this

team; and so on to the right, the drivers regulating the obliquity of their march by their distance from the left flank.

TO CHANGE DIRECTION IN COLUMN.

394. The instructor commands:

Head of column to the right (or left.)

The assistant instructor at the head of the column commands:

1. *Right (or left) wheel.*

2. MARCH. 3. FORWARD.

And the change of direction is executed by the teams in succession on the same ground as in No. 308.

TO HALT THE COLUMN.

395. The instructor commands:

Column—HALT.

The column halts as in No. 309.

To resume the march in column, the instructor commands:

1. *Column forward.* 2. MARCH.

OBLIQUE IN COLUMN.

396. The instructor commands:

1. *Teams right (or left) oblique.* 2. MARCH.

At the command MARCH, the lead driver in each team obliques to the right and moves in the oblique direction. He is followed by his middle and wheel drivers, who turn on the same ground and follow in his tracks, so that each team is formed in columns of pairs.

The lead drivers keep on a line with each other, and at such distances, that at the command

FORWARD,

they will move accurately in column in the primitive direction.

The oblique to the left is executed according to the same principles.

TO FORM LINE.

397. **To the front.** The teams, being in column, in march, or at a halt, the instructor commands:

1. *Forward into line—left oblique.* 2. MARCH.
3. *Guide right.* 4. FRONT.

At the command MARCH, the lead team advances 18 yards, and is halted by its assistant instructor. The other teams oblique to the left, as in No. 396, and when they have gained sufficient ground in that direction, each in succession moves forward, places itself on the line 9 yards from the team which preceded it, and dresses to the right.

The assistant instructors oblique with the teams and take their places in line.

The line is formed gaining ground to the right on the same principles.

398. **To the right or left.** Being in march, or at a halt, the instructor commands:

1. *Right (or left) into line, wheel.* 2. MARCH.
3. HALT. 4. *Right-DRESS.* 5. FRONT.

At the command MARCH, the lead drivers each execute a wheel to the right, as in No. 294, except that when the wheel is completed they move straight to the front. They are followed by the middle and wheel drivers, who wheel successively on the same ground and follow in the tracks of the leaders.

As soon as the wheel drivers are in the new direction, the instructor commands: 3. HALT; 4. *Right-DRESS*, and the assistants take their places in line.

The line is formed to the left according to the same principles.

399. **On the right or left.** Being in march, the instructor commands:

1. *On the right into line.* 2. MARCH.
3. *Guide right.* 4. FRONT.

At the command MARCH, the lead team wheels to the right, moves forward, and when it has unmasked the column, is halted by its assistant instructor.

The other teams continue to advance. Each passes the one immediately preceding it, wheels to the right, and forms 9 yards on its left, the assistant instructors taking their places in line.

The teams are formed *on the left into line* according to the same principles.

400. In the formations into line, the instructor gives the commands for the guide immediately after the command MARCH, and the command FRONT as soon as the last team is aligned.

The alignment is made on the lead drivers.

TO FORM LINE ADVANCING.

401. The column marching, the line of teams is formed in continuing the march, gaining ground to the right or the left by the commands and according to the principles of No. 374, the teams preserving their intervals of 9 yards in line.

TO ADVANCE IN LINE.

402. The instructor commands :

1. *Teams—forward.*
2. MARCH. 3. *Guide right (or left.)*

The teams move forward, dressing upon the guide indicated. The lead drivers maintain the dress and intervals ; the middle and wheel drivers, preserving their distances of 2 feet from head to croup, follow in their tracks.

Whilst marching in line, in order to secure the proper control of the movements of their horses, the instructor will occasionally cause the drivers to move from the front to the rear of the teams, and the reverse. For this purpose he commands, *Lead driver to the rear.* The driver designated *reverses* in a direction opposite to the guide, and, by another reverse, takes his place in rear of the team. The middle driver gathers his horses, keeps them direct to the front, and becomes responsible for the dress and intervals. He is passed in his turn to the rear, at the command, *Middle driver to the rear,* when the wheel driver keeps the dress and intervals

until passed to the rear by the command, *Wheel driver to the rear.*

In passing from rear to front, at the commands, *Rear* (or —) *driver to the front*, the driver invariably obliques to the right, quickens the gait, and takes his place at the head of the team by inclining to the left.

To advance in line of teams from the position occupied by the pairs in No. 392, the commands are the same. At the command MARCH, all the lead drivers advance, dressing towards the guide, and gradually opening out to 9 yards. The middle and wheel drivers form in column behind the lead drivers, as already directed.

TO HALT.

403. The teams being in line, the instructor commands :

Teams—HALT.

404. The teams being formed and in line, are broken into column from the right or left by the commands and according to the principles of No. 393, the middle and wheel drivers following in the tracks of their leaders, and the latter commencing the movement in time to take their proper positions in column without disorder.

TO MARCH BY A FLANK.

405. The teams being in line, in march, or at a halt, the instructor commands :

1. *Teams, by the right (or left) flank.*
2. MARCH. 3. *Column*—FORWARD.

If the teams are in column, the commands are :

1. *Column, by the right (or left) flank.*
2. MARCH. 3. FORWARD. 4. *Guide right (or left.)*

Each team executes the wheel and moves forward, the assistants taking their proper positions.

OBLIQUE IN LINE.

406. The teams being in line, in march, or at a halt, the instructor commands:

1. *Teams, right (or left) oblique.* 2. MARCH;

which are executed as prescribed in No. 396. During the oblique, the guide is on the flank towards which the oblique is made. At the command FORWARD, the guide reverts to the original flank, or, if the oblique commenced from a halt, the command for the guide will be added to the command FORWARD.

THE REVERSE.

407. The teams being in line or in column, in march or at a halt, to form, faced in the opposite direction, the instructor commands:

1. *Teams, right (or left) reverse.*

2. MARCH. 3. HALT.

At the command MARCH, the lead drivers execute the reverse and move forward, as in No. 317, at the gait at which they were marching when the movement commenced. The middle and wheel drivers, preserving their distances, execute the reverse on the same ground, and follow in the tracks of the leaders. When they are all accurately in the new direction, the instructor commands HALT, or *Column, HALT.*

If he wishes to move forward at the completion of the reverse, instead of the command HALT, the instructor commands: FORWARD, *Guide right, (or left,)* or *Column, FORWARD,* as the case may be.

CHANGES OF GAIT.

408. The movement at the different gaits are executed according to the principles and by the commands laid down in No. 318.

TO REST.

409. The teams being in line or column, are halted, the drivers dismounted, and the rest ordered as in No. 184.

To rest in marching, the means prescribed in No. 185 are used.

TO FILE OFF.

410. The teams being in line, in front of the stables or picket, the drivers are dismounted, and file off as in No. 300.

If the teams approach the parade or picket by a flank, the drivers may be formed into line on the right or left in the same order as in No. 392 by the commands and means prescribed in Nos. 312 and 313.

THE PIECE HORSED.

411. From four to eight pieces may be united for instruction. As the movements of the carriages of the pieces and caissons are the same, the caissons may be horsed and considered as pieces.

There is an assistant instructor to every two carriages. Their posts in line or column are the same as directed for the teams; they see that all the movements are correctly performed.

The carriages are taken in park, either in one line, or, as usually parked, with the caissons in rear of their pieces. The *teams* are always formed as if the carriages were in one line, the teams of the rear carriages on the left of those of the leading carriages of the same file.

TO ENTER THE PARK.

412. The teams being formed in line, and in the same order as the carriages to which they belong, approach the park as circumstances require. If they are to enter by its left, they are broken into column from the right. If they are to enter the park by the right, they are broken into column from the left.

The instructor directs the column towards the flank of the park, and when its head is near the first carriage, he commands:

1. *Teams, to your posts.* 2. MARCH.

(PLATE 23, Fig. 3.) At the command MARCH, the column takes such a direction as will lead it in front of and near the poles of the carriages, and parallel to the line of the park; each team, when within 3 yards of its carriage, changes its direction to the left, and halts.

If there are several lines of carriages, the teams of the second break off from those of the first at the command MARCH, and form a column which executes, with reference to the second line, a similar movement to that just described. The teams of the third line execute for that line what has been prescribed for the second, etc.

If the teams are in line, in rear, or in front of the park, and the spaces between the carriages sufficient, they are marched towards the park in line, and the instructor commands: *Teams, to your posts*—MARCH. The teams, passing to the right of their respective carriages, take their positions in front of the poles.

HITCHING THE TEAMS.

413. The instructor dismounts the drivers, and commands:

HITCH.

At this command, each driver goes in front of his horses, faces towards them, seizes with his right hand the reins of his near horse, and, with his left hand, the coupling rein of his off horse. The wheel driver then backs his horses so that they may be easily hitched, opens the branches of the pole yoke, fixes the toggles to the sliding rings, commencing with his off horse, and fastens the pole strap to the sliding loops of the breast straps, commencing with his near horse. He then goes in rear of his off horse, passing by the right, detaches his traces and hitches them to the splinter bar, commencing with the inner trace of the near horse and ending with the outer trace of the off horse. He then passes round the rear of the carriage at double quick, detaches the outer trace of the near horse, hitches it to the splinter bar, and resumes the position of STAND TO HORSE.

The middle driver, as soon as the pole straps are secured, backs his horses, lashes the reins of the near horse to the coupling rein, in order to secure them, moves behind his off horse, passing by the right, detaches the traces, and when the off wheel horse is hitched, fastens them, commencing with the outer trace, and being careful to put the inner traces above the pole straps. He finishes

by hitching the outer trace of the near horse, and resumes the position of **STAND TO HORSE**.

The lead driver regulates himself by the middle driver, conforming to what has been prescribed for that driver.

The instructor carefully examines whether the traces are equal and well stretched, and of the proper length; whether the leathers are on the flat side, and the breeching well placed, etc., and finally passing from one part to another, causes whatever is wrong to be corrected.

414. When the cannoneers are at their posts in time, they may be required to hitch instead of the drivers. When this is to be done the drivers are not dismounted. At the command *Cannoneers*, **HITCH**, Nos. 1, 2, 3, and 4 hitch the horses of the caissons, the gunner and Nos. 5, 6, and 7 those of the piece. Each hitches on his own side, Nos. 1, 2, 5, and the gunner attending to the wheel horses.

With reduced numbers, the four highest, including the gunner, hitch the horses of the gun; the others hitch those of the caissons, commencing with the wheel horses, and each number on his own side.

The command, *Cannoneers*, **UNHITCH**, is executed in a corresponding manner.

TO UNPARK.

415. Everything being in proper order, the instructor commands:

STAND TO HORSE.

At this command, the drivers come to attention, the wheel driver runs to the end of the splinter bar, lifts it, raises and fastens the pole prop, and resumes his position; the instructor then mounts the drivers and commands:

1. *By piece, from the right—front into column.*

2. **MARCH.**

(**PLATE 23, Fig. 4.**) At the first command, the drivers gather their horses.

At the second command, the carriages of the right file move

straight to the front, and are followed by those of the file next on the left, the leading one of which, commencing to move when the hind wheels of the rear carriage of the right file are opposite its leaders, obliques to the right and takes its place in column in rear of that file; it is followed by the other carriages of its file, which march directly in its track.

This movement is executed successively by the other files, the leading carriage of each increasing the obliquity of its march in proportion to its distance from the right flank. The carriages preserve in column the distance of 2 yards from each other.

When the pieces are parked in one line, the movement is executed in the same way, each carriage moving when the hind wheels of the one on its right are opposite its leaders.

Unparking from the left is executed according to the same principles and by inverse means.

Before a carriage moves, the traces should be equally stretched, so that at the command MARCH, the horses may pull steadily and together. This precaution prevents those jerks which fatigue the horses and frequently break the harness.

TO HALT.

416. When the carriages are accurately placed in column, the instructor commands:

1. *Column.* 2. HALT.

At the first command, the drivers gather their horses without slackening the gait. At the command HALT, they halt according to the principles of No. 293. The wheel drivers must exert more strength in halting than the other drivers, as their horses have to act against the impulsive force of the carriage. When the carriages are halted, the traces must be stretched by carefully moving the horse a step or two forward.

To resume the march, the instructor commands:

1. *Column, forward.* 2. MARCH.

TO WHEEL.

417. The instructor commands :

1. *Pieces, left wheel.*
2. MARCH. 3. HALT.

(PLATES 25 and 23, Fig. 5.) At the first command the drivers gather their horses, at the second the teams wheel to the left, as in No. 398, and move directly to the front.

The command HALT is given the moment the carriages are fully in the new direction.

In the wheelings, and in the movements which depend on them, the lead driver enters the new direction without making his horses pull; the middle driver does the same; and it is not until the wheel driver is in the new direction that the traces are stretched. This principle is not rigorously applicable on difficult ground.

Wheeling to the right is executed according to the same principles.

TO OBLIQUE.

418. (PLATES 25 and 23, Fig. 6.) The pieces being in line, or in column, the instructor commands :

1. *Pieces, left (or right) oblique.*
2. MARCH. 3. HALT.

Which are executed by each piece according to the principles prescribed for wheeling, observing that the oblique is a half-wheel.

TO REVERSE.

419. Being in line, or in column, to establish the carriages in the opposite direction, the instructor commands :

1. *Pieces, left (or right) reverse.*
2. MARCH. 3. HALT.

(PLATE 23, Fig. 7.) At the command MARCH, the teams reverse as in No. 407, so as to turn the carriage on the shortest curve its construction will permit, and then moves to the front.

School of the driver.

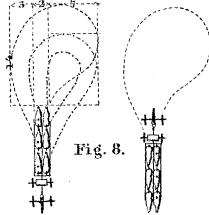
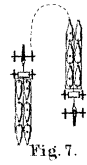
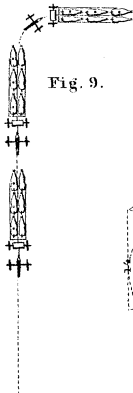
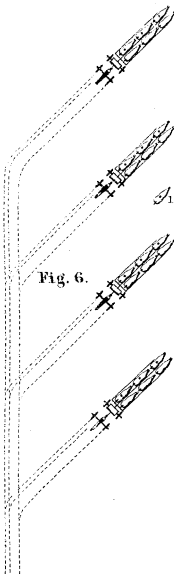
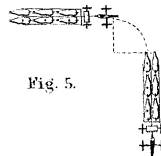
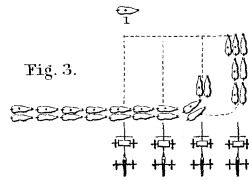
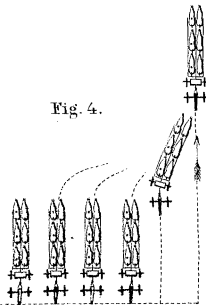
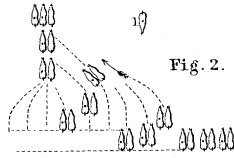
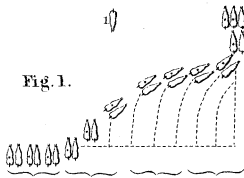

The command **HALT** will be given when the carriage is straight in the opposite direction.

THE ABOUT.

420. To establish the carriages in the opposite direction and on the same ground, the instructor commands :

1. *Pieces, left about.*
2. **MARCH.** 3. **HALT.**

(PLATE 23, Fig. 8.) At the command **MARCH**, the drivers oblique the horses to the right; and the leading driver, after moving 7 yards in that direction, reins his horses to the left in such a manner that the extreme part of the curve they describe shall be 14 yards from their point of departure, and that, after passing 3 yards to the left of the original line of direction, they shall return to the ground on which the carriage first stood. The other drivers direct their horses so that the limber wheels shall describe a loop, which, extending 7 yards to the right and 11 to the front of the position occupied by the leaders before starting, shall pass a little to the left of the line of direction, and return in such a manner that the hind wheels, without crossing that direction, shall be brought to the position from which the leaders started.

The command **HALT** is given as soon as the leading horses reach the ground on which the hind wheels stood at the commencement of the movement.

In order that the preceding movement may be better understood, the instructor causes the carriages to execute it in succession. In each instance he precedes on foot the leading horses, and passes over the curve which they are to describe.

421. When it is desired to move forward, at the completion of the foregoing movements, instead of the command **HALT**, the instructor commands :

FORWARD ;

and the pieces move direct to their front.

TO CHANGE DIRECTION IN COLUMN.

422. The instructor commands :

Head of column, to the right (or left.)

The leading assistant commands :

1. *Right (or left) wheel.*
2. MARCH. 3. FORWARD.

(PLATE 23, Fig. 9.) The leading carriage executes the wheel, and at the command FORWARD, moves directly to the front. The other carriages wheel successively on the same ground, keeping their distances of 2 yards.

THE ABOUT IN COLUMN.

423. The column being in march, or at a halt, the instructor commands :

1. *Pieces, left about.*
2. MARCH. 3. FORWARD.

The drivers of each piece execute the about as prescribed in No. 420, and without halting move forward at the third command.

The drivers of the last carriage, which is to become the head of the column, must be careful to execute the about without slackening the gait, in order not to delay the other carriages.

This movement is performed at a walk, and the instructor, without requiring all the carriages to come about at the same time, must carefully observe and correct, if necessary, the means employed by the drivers for executing it.

CHANGES OF GAIT.

424. The gaits are changed according to the principles of No. 318.

The column being at a halt, is moved forward at a trot, by the command :

1. *Column, forward—trot.*
2. MARCH.

Care should be taken that all the drivers start their horses off together.

Marching at a trot, to halt, the instructor commands:

Column—HALT.

The drivers halt their horses quickly, but not suddenly; a carriage moving at a rapid rate cannot be halted at once, but must advance 5 or 6 yards after the command HALT is given.

TO MARCH BY A FLANK.

425. The column being in march, or at a halt, the instructor commands:

1. *Column, by the right (or left) flank.*
2. MARCH.
3. FORWARD. 4. *Guide right (or left.)*

At the command MARCH, each piece wheels to the right, (or left;) and at the command FORWARD, moves to the front, dressing towards the guide, and preserving the intervals, which are 14 yards.

TO HALT.

426. When in line, the instructor commands:

Pieces—HALT.

To resume the march, the commands are:

1. *Pieces, forward.*
2. MARCH. 3. *Guide right (or left.)*

427. The pieces being in march, or at a halt, to resume the march in column, the instructor commands:

1. *By the left (or right) flank.*
2. MARCH. 3. *Column, FORWARD.*

TO REST.

428. The instructor wheels the pieces into line, halts, and dismounts the drivers. Whenever the drivers are dismounted, and immediately on dismounting, the wheel driver lets down the pole prop, raising the splinter bar so as to enable the prop to rest

upon the ground, and support the pole. He then commands **REST**. The drivers remain near their horses.

During the rest, the instructor sees that the drivers arrange every part of their harness which may have been displaced during the drill. He should occasionally question the drivers, to ascertain whether they understand the principles they have been applying.

In executing the various movements when in march, the instructor will see that the drivers apply the principles prescribed for the same movements at a halt.

429. To resume the exercise, the instructor commands :

ATTENTION!

At this command all take their posts, and the wheel drivers raise and fasten the pole props.

TO REIN BACK TO THE RIGHT.

430. The instructor commands :

1. *Pieces, to the right and backward.*

2. **MARCH.** 3. **HALT.**

At the first command, the drivers direct the poles to the right without advancing or backing the carriage. At the second, they rein the horses back as prescribed in No. 298, taking care to keep them to the right.

At the command **HALT**, they place the team and carriage in line and halt, stretching the traces.

Backing to the left is effected according to the same principles, and by inverse means.

The instructor directs the drivers to make the off wheel horses back a little sooner than the others.

Whenever carriages have to execute an about in a narrow space, as a street, for instance, this mode of backing is necessary. In this case the drivers, after obliquing to the right (or left) until within 4 yards of the wall, back to the right (or left) until the hind part of the carriage touches the wall, and then execute a *reverse*.

TO DISMOUNT WHILST MARCHING.

431. The horses marching quietly, and the distance being well observed, the instructor commands: (*such*) *driver*—DISMOUNT.

The driver designated lets the reins slip on his horse's neck, and dismounts without abandoning his whip, observing to plant his right foot as far as possible in advance of the horse's shoulder; he quickly disengages his left foot from the stirrup, and moving opposite the near horse's head, seizes the left rein with his right hand.

TO MOUNT WHILST MARCHING.

432. The instructor commands: (*such*) *driver*—MOUNT. The driver designated lets go the reins, faces to the right about, places his left hand on the head of the collar, seizes the stirrup with his right hand, and quickly inserts his left foot; he then rests his right hand on the cantle, raises his right leg, and, passing it over the croup, places himself lightly in the saddle.

To avoid accident, the instructor first practices the men in executing these movements at a halt, not exacting that all shall dismount or mount at the same time.

TO PARK.

433. The instructor directs the column towards the park, and gives, according to the position of the ground on which the pieces are to be parked, one of the following commands:

1. *At—yards interval.* { *Forward into park—right (or left) oblique.*
To the right (or left) into park.
On the right (or left) into park.

2. MARCH.

To form forward into park. The column approaches the park from the rear, the leading piece being in rear of the ground on which it is to rest.

At the command MARCH, the leading piece marches direct to the front and halts, on the caution of the assistant instructor, at

its proper place; all the other carriages oblique to the right (or left) until near their places in park; when they change direction to the front so as to come up square on the line. They halt a little in rear of the line, and dress forward on the carriage already established.

To form to the right into park. The instructor, approaching the park by its right, directs the column parallel to the front and 40 yards behind it. At the command **MARCH**, which is given when the leading piece is 3 yards from the point opposite the position which it is to occupy, the assistant instructor wheels it to the right, moves it forward, and halts it at its position. The other carriages move straight forward; each one wheels to the right when 3 yards from the point opposite to the position it is to occupy in park, marches forward, and places itself on the right of and in line with those already established.

To form to the left into park is executed according to the same principles, and by inverse means.

To form on the right into park. The instructor, approaching the park by its right, directs the column parallel to the front and 40 yards in rear.

The leading piece is wheeled to the right and established in its position as before; the next, passing in rear of it, places itself in line on its left in like manner, and so with the others.

When the park consists of two or more lines, the same principles are observed; each carriage of the rear ranks follows its file leader in its movements.

The park should be formed on the left according to the same principles, and by inverse means.

TO UNHITCH.

434. The park being formed, the instructor causes the drivers to dismount as prescribed, and commands:

UNHITCH.

The lead driver goes in front of his horses, faces towards them, backs them in order to unhitch more easily, lashes the reins of the near horse to the coupling rein, then passing by the left of

his near horse, unhitches his traces, commencing with the outer one, bends them and fastens them by means of the trussing straps. He unhitches the off horse in the same manner, commencing, however, with the inner trace, and, having finished, he passes to the rear of his horses, and resumes the position of *stand to horse*, first unlash the reins.

The middle driver unhitches, conforming to what has been prescribed for the lead driver.

The wheel driver goes to the splinter bar, lets down the pole prop, unhitches, bends and fastens the traces of the near horse, and the inner trace of his off horse, passes at double quick around the carriage, unhitches and fastens the outer traces of the off horse; then goes in front of his horses, and, commencing with the near horse, unfastens the pole straps; detaches the toggles from the sliding rings, commencing with the off horse; unites the branches of the pole yoke, and resumes the position of *stand to horse*.

TO LEAVE THE PARK.

435. The instructor mounts the drivers, and commands:

1. *By team, from the right (or left)—front into column.*

2. MARCH.

At the command MARCH, the right (or left) team moves to the front until it is disengaged from the pole, and then changes its direction at the command of the instructor. If the carriages are in two or more ranks, the teams of the same file follow each other, if the intervals between the carriages are sufficient for their passage. They are followed by the other teams or files of teams, which enter the column so as to leave the proper distances between the pairs.

If there are not sufficient intervals between the carriages for the passage of the teams, the instructor commands:

1. *Teams, by the right (or left) flank.*

2. MARCH. 3. FORWARD.

Each team wheels as directed, and moves forward. As the

heads of the column pass out of the park, the teams of the rear rank oblique to the left or right, and take their proper places in column, in rear (or front) of the teams of the front carriages of their files.

The teams are then marched to the stables, or pickets, by the means already prescribed.

NOTE.—The method of instruction prescribed in the riding-house drill may be used with advantage in the elementary instruction of the driver, the team, and the piece. For this purpose a proper drill ground should be laid out, and the prescribed movements executed, so far as practicable, in the manner directed for the cannoneer mounted.

ARTICLE FOURTH.

THE SECTION.

436. In the battery of manœuvre, the section is composed of two pieces and two caissons, horsed and prepared for service.

The piece and its caisson are kept in a fixed relation to each other, and may be said to constitute a unit; the word *piece* being often used to designate the piece and its caisson taken together. They are separated only in the formations in battery, and this simplifies the manœuvres greatly, rendering it generally unnecessary to give separate commands to the caissons.

In the manœuvres, it is immaterial which carriage leads. All the movements should be executed with the caissons in front, after they have been executed with the pieces leading, in order that the drivers may become familiar with their duties under all circumstances.

437. When the pieces are in column, each being followed or preceded by its caisson, the section is said to be formed in *column of pieces*. The distances between the carriages, or between the carriages and detachments in horse artillery, are 2 yards.

438. (PLATE 28.) In the order *in line*, the carriages are formed in two lines, fronting in the same direction, the pieces limbered, and each followed or preceded by its caisson.

The *intervals* between the carriages are 14 yards, the *distances* 2 yards.

In horse artillery the intervals are 17 yards, the distances between the carriages, or between the carriages and detachments, 2 yards.

When all the carriages are drawn by four horses, the intervals are diminished 3 yards; when they are drawn by eight horses, the

intervals are increased 3 yards, the *distances* being the same in each case.

Should a portion of the teams be reduced a pair of horses or more, allowance must be made for the deficient horses by increasing the *distances* of those carriages accordingly, estimating the length of a pair of horses in harness at 3 yards.

In both kinds of artillery these arrangements are the same, whether the pieces or caissons lead.

439. (PLATE 29.) In the order *in battery*, the pieces are unlimbered and prepared for firing. The pieces, limbers, and caissons are turned towards the enemy, each piece having its limber and caisson behind it.

The *intervals* in both mounted and horse artillery are the same as in line.

The distances in battery are the same for both kinds of artillery. Between the piece and limber it is 6 yards, measuring from the end of the handspike to the heads of the lead horses; between the limber and caisson it is 11 yards, measuring from the rear of the limber to the heads of the lead horses of the caisson.

The cannoners are at their posts, (No. 95,) and, in *horse artillery*, the detachment of horses is 4 yards in rear of the limber, and held by the horse holders.

The pieces, whether in line or in battery, are designated according to their actual position in the section, as the *right piece* and *left piece*.

POSTS OF OFFICERS AND NON-COMMISSIONED OFFICERS.

440. The chief of the section is ordinarily the instructor. His position is, *in line*, midway between his leading carriages and on a line with their lead drivers; but he moves to any point at which his presence may be required, or from which he can best superintend the movements. *In battery*, his position is in the centre of his section and half-way between the lines of his pieces and limbers. When the captain is instructor the chief of the section acts as assistant, and repeats the commands.

The chiefs of pieces act as guides, and direct the movements of the carriages. Their positions, both in line and in column of pieces, are on the left of and near the lead drivers of their leading carriages. They wear the sabre sheathed, unless it is ordered to be drawn, and mount and dismount at the commands given for the drivers. In *horse artillery* they are also guides, except when the caissons lead, in which case the chiefs of caissons are guides.

In *battery* each chief of piece is ordinarily outside the file, on the left of his piece, but near it, and opposite the middle of the trail handspike. During the real execution of the firings, he dismounts and gives the reins of his horse to the driver of the wheel horses of the limber.

In *horse artillery* the chief of caisson also dismounts and gives the reins of his horse to the wheel driver of the caisson.

441. Alignments are made on the drivers of the wheel horses, except in *battery*, when they are made on the wheels of the pieces.

442. The section is taken at the park, the teams hitched, the chiefs of pieces and drivers dismounted; the detachments formed either in front or rear of their pieces; the cannoneers equipped for the service of the guns. The chief of section superintends the preparation of his section, and sees that the duties are correctly performed.

In mounted batteries the cannoneers wear the sabre belts only, the sabres being carried on the ammunition chests. The drivers, and, in *horse artillery*, the cannoneers also, wear their sabres, unless special directions are given to the contrary.

443. The instructor explains the meaning of the terms *interval*, *distance*, etc., and such other terms as may be used in the course of instruction. He also explains the objects of the different movements before executing them. During the rests he questions the men, and especially the non-commissioned officers, to see that they understand the movements and the principles which govern their execution.

POSTS OF THE CANNONEERS.

444. During the manœuvres the cannoneers are either at their posts as in No. 95, or they are seated on the ammunition chests as follows:—the gunner, and Nos. 5 and 6, on the limber chest of the piece, the gunner on the right, and No. 5 on the left; Nos. 1, 2, and 7 on the limber chest of the caisson, No. 2 on the right and No. 1 on the left; Nos. 3, 4, and 8 on the middle chest of the caisson, No. 4 on the right, and No. 3 on the left.

When circumstances require it, Nos. 6 and 7 may be directed to mount the rear chest of the caisson. They sit with their backs to the front, No. 6 on the right.

In horse artillery, the cannoneers are in detachments of two ranks, and habitually in rear of their pieces. The detachments may be ordered to the right or left for greater convenience in making a rapid movement, or for coming into battery to the rear when the caissons are in front. But, as their positions on the flanks are inconvenient for manœuvre, they should be ordered to the rear as soon as the special object has been accomplished. Their proper places in rear should be always kept open for that purpose.

TO MOUNT AND DISMOUNT THE CANNONEERS.

445. **To mount.** The instructor halts the carriages if not already at a halt, and commands:

1. *Cannoneers, prepare to mount.*
2. MOUNT.

At the first command, the cannoneers run to their respective places, and stand facing the chests which they are to mount, the gunner and No. 5 in rear of the gun limber; No. 6 on the right of the gunner; Nos. 1 and 2 in rear of the caisson limber; No. 7 on the left of No. 1; Nos. 3 and 4 in front of the middle chest of the caisson; No. 8 on the right of No. 3. The gunner, and Nos. 2 and 3, seize the handles with the right hand, and step upon the stocks with the left foot, and Nos. 5, 1, and 4, seize the

handles with the left hand, and step upon the stocks with the right foot.

At the command MOUNT, the gunner, and Nos. 1, 2, 3, 4 and 5, spring into their seats. The gunner, and Nos. 5, 1, and 2, seat themselves in their places with their backs to the front, and immediately face about by throwing their legs outward over the handles.

No. 8 then springs into his seat in the same manner as No. 3; Nos. 6 and 7 step in rear of their chests, place their hands upon them, step upon the stocks with their nearest feet, spring up, step over the boxes and take their seats, placing their hands on the shoulders of the men already seated in order to steady themselves.

When the command *Cannoneers*, MOUNT, is given by itself, the men run to their places and spring into their seats at once, No. 8 taking his seat before No. 3.

446. **To dismount.** The instructor halts the carriages as before, and commands :

1. *Cannoneers, prepare to dismount.*

2. DISMOUNT.

At the first command, the cannoneers stand up in their places, except the gunner and No. 5, who face about. At the second command, the whole jump off and run to their posts.

When the command *Cannoneers*, DISMOUNT, is given by itself, the men jump from their chests in the same manner.

447. The cannoneers always dismount at the command ACTION FRONT, RIGHT OR LEFT. They also dismount at the command IN BATTERY, as soon as the carriage on which they are mounted, halts.

In horse artillery, the gunner dismounts the cannoneers when the command ACTION FRONT, RIGHT OR LEFT, OR IN BATTERY is given, and all move to their posts in double quick, and unlimber as rapidly as possible.

The object of mounting the cannoneers on the ammunition chests is generally to enable the battery to make quick movements. Care should be taken when the ground is unfavorable, or the movements are likely to be prolonged, not to mount them so often

as to be injurious to the horses. After they are well instructed in mounting and dismounting at a halt, the cannoneers may be ordered to mount and dismount whilst the carriages are in march at a walk.

448. When a caisson is absent, or temporarily disabled, and a quick movement is necessary, Nos. 1, 2, and 3 will mount the off horses of the piece, No. 2 the lead, No. 1 the middle, and No. 3 the wheel horse; Nos. 1 and 3 passing by the rear of the gun. This arrangement may also be resorted to in case of a sudden alarm, the drivers of the caissons assisting the drivers of the pieces by harnessing their off horses and hitching them in. The cannoneers then mount as directed, and the pieces move off. The remaining cannoneers assist the drivers of the caissons to harness and hitch in their horses, and then mount the chests of the caissons, which proceed at once to join their pieces.

TO UNPARK.

449. As soon as the teams are hitched, the cannoneers equipped, and the detachments posted, a minute inspection is made by the chiefs of pieces, who report to the chief of the section. Everything being prepared, the instructor commands:

1. *By piece from the right, (or left,) front into column.*
2. MARCH.

At the command MARCH, the piece designated marches directly to the front, followed by its caisson at a distance of 2 yards, measured from the rear of the leading carriage to the heads of the horses. The other piece and its caisson oblique so as to enter the column, and follow the movements of the leading piece, each so regulating its march by that of the carriage which precedes it as to move in the same direction at 2 yards distance.

In horse artillery, the same distance is taken between the detachments and the carriages which precede and follow them.

TO FORM THE SECTION.

450. The column of pieces being at a halt, or marching at a

walk, to form the section, gaining ground to the left, the instructor commands :

1. *Form section, left oblique.*

2. MARCH. 3. *Guide right.*

(PLATE 30.) At the command MARCH, the first two carriages, piece and caisson, advance 5 yards and halt. The two rear carriages oblique to the left, gain their intervals of 14 yards, then move forward, and place themselves abreast and on a line with the other two, dressing to the right.

The instructor, or the chief of the section if the captain is the instructor, takes his place midway between the leading carriages, and on a line with the lead drivers.

When the column of pieces is marching at a trot, the formation is executed according to the same principles and by the same commands; but the leading carriages, instead of advancing 5 yards and halting as before, pass to a walk as soon as the command MARCH is given. The other carriages oblique at a trot, and, when abreast the leading ones, pass to a walk, dressing to the right.

When the column of pieces is marching at a walk, to form the section at a trot, the commands are :

1. *Form section, left oblique—trot.*

2. MARCH. 3. *Guide right.*

At the command MARCH, the two leading carriages continue to march in the original direction at a walk. The two following oblique to the left, gain their intervals at a trot, and resume the walk when opposite the leading carriages.

The section is formed, gaining ground to the right according to the same principles. The commands are : *Form section, right oblique*; or, *Form section, right oblique—trot*; MARCH; *Guide left*.

TO MARCH AND TO HALT

451. The section being formed, and at a halt, to put it in motion, the instructor commands :

1. *Section, forward*, or *Section, forward—trot.*

2. MARCH. 3. *Guide left (or right.)*

W

At the command MARCH, all the carriages advance; the guide maintains the direction; and the carriages, and also the detachments in horse artillery, preserve their intervals and distances.

To halt, the instructor commands :

Section—HALT.

The carriages are all halted, keeping dressed, and not stopping too suddenly.

CHANGES OF GAIT.

452. The changes of gait in column of pieces or in line, are executed at the command of the instructor as in No. 424.

When the rapid gaits are to be maintained for any considerable period of time, the instructor will cause the cannoneers to mount the ammunition chests before increasing the gaits.

As a general rule, the cannoneers should mount the ammunition chests only for rapid movements; and when within range of the enemy's guns they should dismount, unless important considerations require a continuation of the rapid gaits. The explosion of a caisson might destroy many of the men seated on the chest.

TO CHANGE DIRECTION.

453. The section being in march or at a halt, to change direction to the left, the instructor commands :

1. *Section, left wheel.*

2. MARCH. 3. FORWARD.

(PLATE 35.) At the command MARCH, the pivot carriage executes the wheel without changing the gait, the carriage on the wheeling flank wheels in such manner as to conform to its movements, increasing the gait, and preserving the intervals. At the command FORWARD, which is given as soon as it is in the new direction, the pivot carriage moves direct to the front; the other resumes its original gait after completing the wheel and arriving upon the same line. The carriages of the rear rank preserve their distances, and follow those of the front rank.

The instructor gives the first command in time to command

MARCH, when the heads of the leaders of the leading carriages are 3·25 yards from the wheeling point. The command FORWARD, must be given as soon as the leading pivot carriage has executed the wheel.

To halt the section, when its wheel is completed, the command

4. *Section*—HALT

is given as soon as the rear carriage is square in the new direction.

The change of direction to the right is executed according to the same principles.

An *oblique change of direction* is executed by the section, according to the same principles, at the commands :

1. *Left (or right) half-wheel.*
2. MARCH. 3. FORWARD.

The command FORWARD being given as the leading pivot carriage is about finishing the left (or right) oblique.

TO MARCH BY A FLANK.

454. The section being in march, or at a halt, to gain ground to the left, the instructor commands :

1. *Section, by the left flank.*
2. MARCH.

(PLATE 31.) At the command MARCH, each piece and caisson wheels at once to the left. When the wheel is nearly completed, the instructor commands :

1. FORWARD. 2. *Guide right.*

At the command FORWARD, all the carriages move directly to the front. The instructor, or chief of section, takes his place between the leading carriages, which keep in line, regulating on the guide, and keeping their intervals of 14 yards. The rear carriages keep their proper distances of 2 yards.

To resume the original direction, the instructor commands :

1. *Section, by the right flank.* 2. MARCH.
3. FORWARD. 4. *Guide right or left;*

which commands are executed according to the same principles, each carriage wheeling to the right, and the chief of section taking his place between the two leading ones.

Whilst marching to a flank the section may be marched in a direction opposite to the original one, the commands being :

1. *Section by the left flank.* 2. MARCH.
3. FORWARD. 4. *Guide left (or right.)*

The flank march to gain ground to the right is executed according to the same principles.

(PLATE 32.) In horse artillery the carriages are aligned on each other as in foot artillery, the distances being 5 yards. The intervals will be 14 or 21 yards, and depend on the relative position of the pieces and caissons, being greatest when the pieces lead. The detachments wheel in the same direction as the pieces, and place themselves at their sides 2 yards from the wheels, the heads of the horses of the front rank being on a line with the axletrees of the limbers. In marching by the left flank they are on the left, and in marching by the right flank they are on the right of their pieces.

In resuming the original direction, the detachments wheel in the same direction as their pieces, and place themselves at once in rear of them ; but in marching in the opposite direction they resume their places by allowing the pieces to pass them, and then taking post in their rear.

THE OBLIQUE.

455. The section being in march, or at a halt, to cause it to gain ground to the left and front, the instructor commands :

1. *Section, left oblique.* 2. MARCH.

(PLATE 33.) At the command MARCH, all the carriages oblique at once to the left, as prescribed in No. 418, and march in the new direction, moving in parallel lines, and preserving their intervals.

In obliquing, the heads of the horses in each rank are on a line parallel to the original front. The interval is 14 yards, measured parallel to the front, and 10 yards if measured on a line perpen-

dicular to the oblique direction. In mounted batteries, each carriage of the right file marches in the prolongation of the left carriage of the rank which precedes its own, and at a distance of 9 yards.

The chief of section conforms his movements to those of the section, and preserves his relative position.

To resume the original direction, the instructor commands :

FORWARD,

and the carriages resume the original direction and guides.

To halt the section, during the oblique, the instructor commands :

Section—HALT.

To resume the march, in the oblique direction, he commands :

Section—MARCH.

(PLATE 34.) In horse artillery, the carriages oblique according to the same principles. They also form ranks whose fronts are parallel to the original front of the section. The detachments follow in rear of their pieces.

The right oblique is executed according to the same principles.

THE REVERSE.

456. The section being in line, or in column of pieces, in march, or at a halt, to form it faced in the opposite direction, the instructor commands :

1. *Pieces and caissons, left (or right) reverse.*

2. MARCH. 3. HALT.

Each carriage executes the reverse as in No. 419.

THE ABOUT.

457. The section being in line, or in column of pieces, in march, or at a halt, to form it faced in the opposite direction, each carriage upon the same ground, the instructor commands :

1. *Pieces and caissons, left about.*

2. MARCH. 3. HALT.

Each carriage executes the about as in No. 420.

(PLATE 26.) In the **reverse**, and the **about**, in **horse artillery**, the detachment of cannoneers follows the piece, which advances 7 yards after finishing the movement in order that the heads of the lead horses may reach the position occupied by the rear of the detachment at the commencement of the movement.

THE COUNTERMARCH.

458. The section being in line, or in column of pieces, in march, or at a halt, to form it faced in the opposite direction, on the same ground, and with the same carriages in front, the instructor commands:

1. *Countermarch*. 2. MARCH. 3. HALT.

(PLATE 26.) At the command MARCH, the leading carriage of each piece executes the about, and moves at once to the position occupied by the rear carriage at the commencement of the movement. The latter follows the track of the former, executes the about on the same ground, and takes its place. When the heads of the lead horses of the leading carriage arrive at the position occupied by the hind part of the rear carriage at the beginning of the movement, the instructor commands: HALT, or *Column*, HALT.

In **horse artillery**, when the piece is in rear, the caisson, after executing the about, moves forward, and is halted when its lead horses are upon the ground occupied by the horses of the rear rank of the detachment at the commencement of the movement.

459. In the **reverse**, the **about**, and the **countermarch**, the chief of the section, and the chiefs of pieces, take their places in line or column according to the changed position of the section.

When the instructor wishes to move forward at the completion of these movements, instead of the command HALT, he commands FORWARD, *Guide right*, or *Column*, FORWARD, according to the formation of the section.

These movements may be executed at the trot; but care must be taken that the space occupied in coming about be sufficient, and the gait so moderated as to avoid the danger of upsetting

the carriages, especially when the cannoneers are on the chests, at which time they are most liable to that accident.

PASSAGE OF CARRIAGES.

460. The section marching at a walk, in line, or in column of pieces, to change the relative positions of the front and rear carriages of the pieces without altering the gait, the instructor commands:

1. *Pieces, pass your caissons, (or Caissons, pass your pieces.)*

2. MARCH.

(PLATE 25.) At the command MARCH, the leading carriage of each piece halts. The rear carriage inclines to the right, passes it, takes the proper distance in front by inclining to the left, and halts. The chief of the piece joins it as it passes. To continue the march without halting the carriages which have passed, the instructor commands FORWARD, when the passage is nearly completed.

When the section is marching *at a trot*, the passage is executed at the same commands and according to the same principles, except that the leading carriages, instead of halting at the command MARCH, move at a walk. The rear carriages execute the passage at a trot, and then change the gait to a walk.

When the section is at a halt, the passage is executed according to the same principles and by the same commands. If at the conclusion of the passage, the instructor wishes to put the section in march, he commands FORWARD as the passage is about being completed.

When the section is in line, the command FORWARD will be followed by the command for the guide.

The section marching at a walk, to execute the passage at a trot, the instructor commands:

1. *Pieces, pass your caissons—trot; (or Caissons, pass your pieces—trot.)*

2. MARCH.

At the command MARCH, the leading carriages continue the

march at a walk. The others execute the passage at a trot, and resume the walk as soon as the passage is completed.

Care must be taken that the carriages passed to the front move in all cases sufficiently in advance before inclining to the left, to avoid injuring the lead horses of the carriages they pass.

TO BREAK THE SECTION.

461. The section marching at a walk, in line, to form column of pieces from the right, at that gait, the instructor commands:

1. *By the right—break section.*

2. MARCH.

(PLATE 30.) At the command MARCH, the two right carriages, piece, and caisson continue to march at a walk; the others halt. The left carriages remain halted until the leaders of the leading carriage are passed by the wheel horses of the rear carriage on the right. They then oblique to the right, take their places in column, and follow the two leading carriages.

When the section is marching at a trot, the column of pieces is formed according to the same principles and by the same commands. But in this case the carriages which halted before slacken the gait to a walk, and resume the trot to oblique and enter the column.

When the section is at a halt, the movement is executed as prescribed for the march at a walk, the two right carriages moving forward at a walk at the command MARCH.

The section marching at a walk, to form column of pieces from the right at a trot, the instructor commands:

1. *By the right, break section—trot.*

2. MARCH.

At the command MARCH, the right carriages move forward at a moderate trot. The left carriages commence the trot on obliquing to enter the column.

When the section is at a halt it is broken at a trot by the same commands and in the same manner. The designated carriages move off at a trot, the other carriages moving forward at a *walk*

when the command MARCH is given. This rule for commencing a movement at a trot is general.

The section is broken from the left according to the same principles.

TO FORM THE CAISSONS ON THE FLANK.

462. The section being in column of pieces with the caissons in rear, to form the pieces and caissons in separate columns, as in the flank march of the section, the instructor commands:

1. *Caissons, left; (or Caissons, left—trot.)*
2. MARCH. 3. *Guide right.*

At the command MARCH, the caissons oblique at once to the left, gain the intervals of 14 yards, and place themselves opposite their pieces, closing upon each other at the same time to the usual distances. The gait is regulated as in the formation of sections, and when the movement is performed at a walk, the leading carriage halts after advancing its own length.

The instructor or chief of section takes his place as in the section in line between the two leading carriages.

The caissons are formed on the right according to the same principles.

When the pieces are in rear, they are formed on the right or left of their caissons in the same manner and by corresponding commands.

TO REPLACE THE CAISSONS IN REAR.

463. The section being formed with the caissons on the flank, to replace them in rear of their pieces, the instructor commands:

1. *Caissons, rear; (or Caissons, rear—trot.)*
2. MARCH.

At the command MARCH, the piece at the head of the column moves forward at the required gait, and its caisson places itself in rear by an oblique. The other pieces move forward in succession, and are followed by their caissons in like manner.

All the carriages preserve the usual distances in column.

This movement is performed at the different gaits and according to the principles prescribed for breaking sections.

To place the caissons in front of their pieces, the commands are:

1. *Caissons, front*; (or *Caissons, front—trot.*)
2. MARCH.

The caissons oblique successively and take their positions at 2 yards distance in front of their pieces, which then follow their movements.

TO FORM THE PARK.

464. The section being in column of pieces, and near the ground on which it is to be parked, will be formed by the commands and according to the principles of No. 433.

The chiefs of pieces direct the march of their carriages.

When the nature of the ground requires it, the detachments are ordered to leave the pieces when they are about entering the park, and to form on ground designated for the purpose.

The detachments and teams are marched from the park by the means already prescribed.

FORMATIONS IN BATTERY.

IN LINE, WITH PIECES IN FRONT TO FORM IN BATTERY TO THE FRONT.

465. The section being at a halt, in line, with pieces in front, to form in battery to the front, the instructor commands:

1. IN BATTERY. *Guide left.*
2. MARCH.

(PLATE 52.) At the command IN BATTERY, the caissons stand fast, and the pieces advance. The intervals and alignment are preserved, and the chiefs of pieces and of the section march at their places in line.

At the command MARCH, which is given as soon as they have advanced 17 yards, the chiefs of pieces and of the section halt, and the pieces execute an about. As soon as the about is com-

pleted, the pieces are halted, unlimbered, and prepared for firing, the limbers being taken to their places in battery by an about.

When the pieces come about, the one already designated as such continues to be the guide, and the alignment is made on it.

When the cannoneers are marching by the sides of their pieces, they halt at the command MARCH, allow their pieces to pass them, change sides, and move forward to the posts they are to occupy when their pieces have completed the about. They are not required to observe any particular order during this movement.

When the cannoneers are mounted on the ammunition chests, those on the caissons dismount and run to their posts at the command IN BATTERY. Those on the pieces dismount after the about.

The chiefs of pieces, and of the section, take their posts *in battery* as soon as that formation is completed. *This rule is general.*

In horse artillery, the movement is executed in the same manner, and by the same commands. But the pieces advance only 10 yards before executing the about. The horses of the detachments do not advance; but at the command IN BATTERY, the cannoneers dismount and run to their posts.

When the section is marching in line with the pieces in front, it is formed in battery to the front according to the same principles and by the commands:

1. IN BATTERY. 2. MARCH.

At the command IN BATTERY, the caissons halt, and *in horse artillery* the detachments do the same, the cannoneers dismounting and running to their posts.

In dismounting or mounting, the cannoneers in horse artillery separate to the right and left of the horse holders, giving the reins to or receiving the reins from them. The horse holders hold the reins of the horses on their right in the right hand; and the reins of those on the left in the left hand.

TO FORM IN BATTERY TO THE FRONT BY THROWING THE
CAISSONS TO THE REAR.

466. The section being in line at a halt, with the pieces or caissons in front, the instructor commands :

ACTION FRONT.

At this command, the pieces are unlimbered and wheeled about by hand. The limbers and caissons, reversing to the left at the same time, move to the rear and take their places in battery at their proper distances by another reverse.

When the cannoneers are mounted on the ammunition chests, they dismount as soon as the command ACTION FRONT is given, and run to their posts.

In horse artillery, the detachments move to the positions of their horses in battery, and dismount at the command of the gunner, unless the number of horses is so small that the horse holders may lead them. In this case the instructor commands *Cannoneers*, DISMOUNT, immediately after the command ACTION FRONT is given.

IN LINE, WITH CAISSONS IN FRONT, TO FORM IN BATTERY TO
THE FRONT.

467. The section being at a halt, the instructor commands :

1. *Pieces, pass your caissons.* MARCH.
2. IN BATTERY. *Guide left.*
3. MARCH.

(PLATE 52.) The pieces pass their caissons, and at the command IN BATTERY, given as soon as the passage is effected, the formation is executed as in No. 465.

In horse artillery, the command IN BATTERY is given when the detachments have passed the caissons.

When the section is marching, the formation is executed according to the same principles, and by the commands *Pieces, pass your caissons*, (or *Pieces, pass your caissons—trot*;)—MARCH. IN BATTERY—*Guide left*—MARCH.

IN LINE, WITH PIECES IN FRONT, TO FORM IN BATTERY TO
THE REAR.

468. The section being at a halt, the instructor commands :

1. *Fire to the rear.*
2. *Caissons pass your pieces—trot—MARCH.*
3. IN BATTERY.

(PLATE 53.) At the command MARCH, the caissons oblique to the right; pass their pieces at a brisk trot; advance 17 yards beyond them, execute a reverse together, and take their places in battery. As soon as they have passed, the instructor commands IN BATTERY; the pieces are unlimbered and prepared for firing.

When the cannoneers are mounted on the chests, the caissons halt before executing the reverse, to allow them to dismount and run to their posts. When the section is at a halt, as in the present case, it is considered better to dismount the cannoneers before commencing the movement.

In horse artillery, at the command IN BATTERY, the detachments incline to the right, pass their pieces at a brisk trot, and take their places in battery by a left reverse. The cannoneers then dismount, run to their posts, unlimber, and prepare for firing.

When the section is in march, the formation is executed according to the same principles, and by the same commands. At the command IN BATTERY, given as soon as the caissons have passed, the pieces halt, and the movement is completed as already directed.

IN LINE, WITH CAISSONS IN FRONT, TO FORM IN BATTERY TO
THE REAR.

469. The section being at a halt, the instructor commands :

1. *Fire to the rear.*
2. IN BATTERY.

(PLATE 53.) At the command IN BATTERY, the pieces are unlimbered and prepared for firing. The caissons move at a brisk trot, and take their places in battery by a left about.

In horse artillery, at the command **IN BATTERY**, the detachments pass their pieces at a trot, move to their places in battery as prescribed in No. 468, dismount, and run to their posts.

When the section is in march, the formation is executed according to the same principles and by the same commands.

IN BATTERY, TO FORM IN LINE TO THE FRONT.

470. Being in battery, to form line to the front with the caissons in rear, the instructor commands :

LIMBER TO THE FRONT.

At this command, the pieces are limbered as directed in No. 115, the caissons closing, without further command, to the proper distances.

If the instructor wishes to place the caissons in front, he commands **LIMBER TO THE FRONT**; and while the pieces are limbering, *Caissons, pass your pieces—trot—MARCH*. The caissons pass, and halt in front of their pieces, unless the instructor wishes the section to advance, in which case he commands **FORWARD—Guide right** (or *left*), as the caissons are completing the passage, and the section moves forward at a walk.

In horse artillery, the horse holders close to 2 yards from their pieces, and there the cannoneers mount.

When the pieces cannot be wheeled about by hand, the instructor commands **LIMBER TO THE REAR**; and when this is executed, if he wishes to retain the pieces in front, he commands :

1. *Pieces, left about; caissons, forward.*
2. **MARCH.** 3. *Section—HALT.*

(PLATE 54.) At the command **LIMBER TO THE REAR**, the pieces are limbered as prescribed in No. 117. At the first and second commands, the pieces execute the about; the caissons closing to the distances of 2 yards. At the third command, given when the about is completed, the pieces halt and place themselves squarely on the line.

If the instructor wishes the section to advance immediately,

instead of the command *Section*, HALT, he commands, FORWARD, *Guide right* (or *left*), and the caissons close on the march.

If the instructor wishes to place the caissons in front, he may cause the piece to be limbered to the rear, as before, and command:

1. *Caissons, pass your pieces—trot—pieces left about.*
2. MARCH.
3. *Section*, HALT. Or, 3. FORWARD; *Guide right* (or *left*.)

(PLATE 54.) The pieces execute the about at once, the caissons move straight to the front, and so pass the pieces during the execution of the about. The section halts or advances as soon as the passage is completed.

471. In horse artillery, the horse holders, immediately on the command LIMBER TO THE REAR being given, lead the horses of the detachment, at a trot, to their positions in rear of the guns, where the cannoneers mount. *This rule is general*, with the exception prescribed in No. 473. If the horses are too numerous or not sufficiently tractable for this, the instructor commands *Cannoneers*, MOUNT, immediately after giving the command LIMBER TO THE REAR. The cannoneers, as soon as the piece is limbered, run to their horses, mount, and the detachment moves to the rear of the piece at a trot.

IN BATTERY, TO FORM LINE TO THE REAR.

472. The instructor causes the pieces to be limbered to the rear; and then if he wishes to place the caissons in front, commands:

1. *Caissons, left about—pieces forward.*
2. MARCH.
3. *Section*, HALT, or FORWARD; *Guide right* (or *left*.)

(PLATE 55.) The caissons execute the about, and the pieces close to their proper distances. The third command is given as the about is completed.

If the instructor wishes to place the pieces in front, he causes them to be limbered to the rear, and commands:

1. *Pieces, pass your caissons—caissons, left about.*

2. MARCH. 3. *Section, HALT.*

Or, FORWARD—*Guide right (or left.)*

(PLATE 55.) At the command MARCH, the pieces pass their caissons by moving direct to the front, the caissons executing the about at the same command, and so regulating the gait as to take their proper distances.

In forming line to the rear, either with pieces or caissons in front, the caissons may be placed at once in position, for greater convenience in mounting the cannoneers. For this purpose, if the caissons are to be in front, the instructor, immediately upon commanding LIMBER TO THE REAR, adds:

1. *Caissons, in front of your pièces.*

Or, *caissons, in front of your pièces—trot.*

2. MARCH.

While the pieces are limbering, the caissons oblique to the right, move forward near the middle of the interval between the leaders of the pieces, place themselves in front of them by two successive wheels to the left, and halt.

If the pieces are to be in front, the commands are:

1. *Caissons, in rear of your pièces.*

Or, *caissons, in rear of your pièces—trot.*

2. MARCH.

The caissons incline to the right, pass their pieces; move sufficiently to the rear, and then by a *left reverse* take their positions in rear of their pieces.

TO MARCH BY A FLANK.

473. The section being in battery, to gain ground to the left for the purpose of forming again in battery, the instructor causes the pieces to be limbered to the rear, and commands:

1. *Pieces right—caissons left wheel.*

2. MARCH.

3. FORWARD. 4. *Guide right.*

(PLATES 66 and 67.) At the command **MARCH**, the carriages wheel as ordered, and at the third and fourth commands move forward with an interval of 8 yards, and a distance of 2 yards.

In **horse artillery** the interval is also 8 yards, but the distance is 5 yards. For this movement, the instructor, before giving the command **LIMBER TO THE REAR**, warns the horse holders to stand fast. As the pieces wheel, the detachments also wheel, so as to march at the sides of their pieces as prescribed in No. 454.

The movement to gain ground to the left may be executed by limbering at once to the left; the caissons wheeling to the left whilst the pieces are limbering, and the instructor afterwards commanding **FORWARD—MARCH—*Guide right.***

In **horse artillery**, the horse holders move to the left of their pieces when limbering to the left.

As soon as the section has reached the position on the left which it is intended to occupy, the instructor commands:

1. *By the left flank—MARCH.*
2. *Fire to the rear—IN BATTERY.*

The command **IN BATTERY** is given as soon as the pieces have completed the wheel.

In **horse artillery**, the detachments follow the movements of the caissons, and take their places in battery.

The movement to gain ground to the right is executed according to the same principles.

If it is desired to form the pieces in battery on the same line, gaining ground to a flank, the section may be limbered to the front, marched by the flank to the position to be occupied, and be formed in battery as already directed.

The same movement may be executed by limbering to the right or left, gaining ground to the flank, halting, and commanding:

ACTION LEFT, OR ACTION RIGHT,

which will be executed as directed in No. 127; the caissons wheeling to the right or left, and taking their places in battery by reversing.

In horse artillery, the detachments wheel to the right or left and take their places in battery.

474. In all cases when the section is formed with the caissons on the right, or on the left of their pieces, it may be formed into battery to the right, or to the left, by the command: **ACTION RIGHT**, or **ACTION LEFT**.

When the pieces are placed in battery by the command **ACTION RIGHT**, the limbers and caissons always take their places in battery by wheeling to the left, gaining their distances to the rear, and then reversing to the left. If the command is **ACTION LEFT**, they wheel and reverse to the right.

475. In all cases when the word **ACTION** enters into the command for forming in battery, the limbers and caissons take their positions by *wheeling* and *reversing*, and never by executing an about.

MOVEMENTS WITH THE PROLONGE.

476. The section being in battery, to fix prolonges to fire retiring, the instructor commands:

FIX PROLONGE TO FIRE RETIRING.

At this command, the limber inclines to the right, wheels to the left about, and halts 4 yards from the trail. No. 5 uncoils the prolonge and passes the toggle to the gunner, who fixes it in the trail by passing it upwards through the lunette, whilst he attaches the other end to the limber by passing the ring over the pintle and keying it.

At the command **RETIRE**, the cannoneers face about and all march on the left of the piece, except Nos. 1 and 3. They keep the implements in their hands, and, at the command **HALT**, face about, resume their posts, and go on with the firing.

Should the piece be loaded at the command **RETIRE**, No. 3 puts in the priming wire. At the command **HALT**, he takes it out again, and No. 1 rams home. If the command **LOAD** be given, when the piece is in motion, No. 5 puts in the charge, and No. 2 serves

vent, receiving from No. 3 the necessary implements for that purpose.

The piece being in action, to fix the prolonge to fire advancing, the instructor commands :

FIX PROLONGE TO FIRE ADVANCING.

At this command, the limber passes its piece on the right and halts when in front of it, Nos. 1 and 3 stepping within the wheels to avoid the limber. No. 5 uncoils the prolonge, carries it to the front, gives the toggle to No. 2, who puts it in the lunette of the axle-strap, whilst he places the ring over the pintle and keys it.

In advancing the men retain their implements and march at their posts. At the command **HALT**, No. 2 takes out the toggle and commands : **DRIVE ON**, upon which the limber takes its place in rear, and the firing is renewed.

When the piece is limbered, to fix the prolonge to fire retiring or advancing, the same commands are given. The piece is unlimbered, and the prolonge attached as before.

To fix the prolonge for passing a ditch or for any other purpose than those mentioned in Nos. 476 and 477, the command is :

FIX PROLONGE.

The prolonge is then fixed to the trail as before.

In moving with the prolonge, the gunner attends the handspike, and, in changes of direction, is careful to circle the trail round in proper time to prevent the prolonge from being cut by the wheels. No. 7 clears the prolonge from the limber wheels, and Nos. 1 and 2 from the gun wheels. In wheeling about, the limber first backs a little, and then describes a small circle. In passing a ditch the gunner takes out the handspike.

In fixing the prolonge for any purpose, the caisson wheels or reverses, if necessary, so that the horses of the limber and caisson may face in the same direction.

To detach the prolonge from the limber and coil it up, the instructor commands :

COIL PROLONGE.

At this command the gunner takes out the toggle, and No. 5

takes off the ring and coils the prolonge, first passing the ring over the upper prolonge hook.

To coil the prolonge and limber to the rear, the instructor commands: **COIL PROLONGE**;—**LIMBER TO THE REAR**. The prolonge is detached and coiled as before, the piece is run towards the limber, which reins back on receiving the command **REIN BACK** from the gunner, and is limbered up. To limber to the front, right or left, the instructor commands: **COIL PROLONGE**;—**LIMBER TO THE FRONT, RIGHT, OR LEFT**; which is executed as already described, the gunner commanding, **DRIVE ON**, as soon as the prolonge is detached.

FIRINGS.

477. When everything is prepared for firing, the instructor commands:

COMMENCE FIRING.

This command, when given by itself, or after the command **LOAD**, is repeated by the chiefs of pieces, and the firing immediately commenced.

When the section is formed for action, the pieces are not loaded until the command **LOAD**, or **COMMENCE FIRING**, is given by its chief. When the command **LOAD** is given, the pieces are loaded; but the firing does not commence until ordered.

After the loading is completed, if the firing is to be by section, the instructor commands: *Section*, **FIRE**, and the pieces are fired together; if the firing is to be by piece, the instructor commands *Right (or left) piece*—**FIRE**, and the piece designated is discharged. These commands are not repeated by the chiefs of pieces. In both cases the pieces are again loaded as soon as discharged, but await the orders of the instructor for firing.

If after the loading is completed, or at any time, the instructor gives the command **COMMENCE FIRING**, the firing is continued by the chiefs of pieces under the direction of the chief of section.

For the real execution of the firings, the instructor gives the preparatory commands: *Load with cartridges, (or shot-shell, etc. as the case may be)*—**LOAD**, or **COMMENCE FIRING**. These

commands are repeated by the chiefs of pieces and of the section.

The firing is discontinued at the command or signal **CEASE FIRING**, which is repeated by the chiefs of pieces and of the section.

At this command, such pieces as are loaded must be fired, or the load withdrawn, except in the case where the section retires with the prolonge fixed. In no case should a piece be *limbered* whilst loaded. To draw the load, the worm is used by No. 1, and No. 2 takes charge of the ammunition.

TO FIRE TO THE REAR.

478. The section being in battery, in order to fire in the opposite direction, the instructor causes the firing to cease, and commands :

1. *Fire to the rear.*
2. *Limbers and caissons, pass your pieces—trot.*
3. **MARCH.**

(PLATE 71.) At the command **MARCH**, the pieces are wheeled about by turning the trails to the left, the limbers and caissons oblique to the right, pass their pieces, gain sufficient distance, and take their places in battery by a left reverse.

In horse artillery, the horses follow their limbers, pass them, and take their places by a left reverse. When the horse holders cannot conduct them alone, they are assisted by Nos. 1 and 2.

When the pieces cannot be turned by hand, the instructor commands :

1. *Fire to the rear.*
2. *Limbers to the rear.*
3. *Caissons, pass your pieces—trot—MARCH.*
4. *Pieces, left about—MARCH.*
5. **IN BATTERY.**

PART V.
SCHOOL OF THE BATTERY.

ARTICLE FIRST.

GENERAL PRINCIPLES.

THE manœuvres of a field battery are intended to furnish the instruction required for conducting its movements and formations, in all situations in which it can be employed. These manœuvres are taught to the non-commissioned officers theoretically and practically. The theoretical instruction should embrace everything under the head of general remarks. The practical instruction should commence with the most simple movements, executed at a walk, and as the instruction advances the gait should be increased. Each movement should be repeated until it is fully understood, and executed without hesitation, by all who co-operate in its performance.

The text applies especially to batteries whose cannoneers are not mounted; but it becomes equally applicable to horse artillery, by inserting the proper intervals and distances with the detachments of mounted cannoneers. (See the orders in column, in line, and in battery.)

When the detachments in horse artillery are required to make any particular movements, directions will be given for them. But in general, as they have only to follow 2 yards in rear of the muzzles of their pieces, they will not be mentioned.

The movements are described for one flank only. They may be executed by the other flank, according to the same principles, and by inverse means.

FORMATIONS OF THE BATTERY.

479. The three following orders constitute the different formations of the battery of manœuvre.

1. ORDER IN COLUMN.
2. ORDER IN LINE.
3. ORDER IN BATTERY.

(PLATE 27.) The order in column is that in which the battery is formed by sections; the carriages being in two files, and each piece being followed or preceded by its caisson.

The captain is generally 14 yards from the column and opposite to its centre. But during the manœuvres he moves wherever his presence may be most necessary, and where his commands may be best heard.

Each chief of section is in line with his leading drivers, and midway between his leading carriages.

The chief of the line of caissons is in line with the captain, on the opposite side of the column, and 4 yards from it. But he does not change his position to conform to that of the captain.

Each chief of piece is on the left and near the leading driver of his leading carriage. In horse artillery, when the chiefs of caissons are mounted, each chief of carriage is near its leading driver on the left.

The trumpeters are near the captain.

The guidon is habitually next the chief of the leading piece, or guide of the leading section, but takes post wherever the captain may direct.

In mounted batteries.

The interval between the carriages is 14 yards. The distance between the carriages is 2 yards. The cannoners are in file on each side of their pieces, or mounted on the chests.

In horse artillery.

The interval between the carriages is 17 yards. The distance between the carriages, and between the carriages and detachments, is 2 yards.

The detachments, formed in two ranks, are 2 yards in rear of their pieces.

In both kinds of artillery, these arrangements for the column are the same whether the pieces or caissons lead.

ORDER IN LINE.

(PLATE 28.) The order in line is that in which the carriages are formed in two lines; the horses all facing in the same direction, the pieces limbered, and each followed or preceded by its caisson.

The captain is generally 4 yards in front of the centre. But, during the manœuvres, he goes wherever his presence may be most necessary, and where his commands may be best heard.

Each chief of section is in line with his leading drivers, and midway between the leading carriages of his section.

The chief of the line of caissons is opposite the centre, 4 yards behind the rear line of carriages.

Each chief of piece and caisson is in the same position as in column.

The trumpeter, when he does not accompany the captain, is in line with the leading drivers, and 4 yards from the right flank.

The guidon is on the left of the trumpeter.

In foot artillery.

The interval between the carriages is 14 yards.

The distance between the two lines is 2 yards.

The cannoneers are at their posts as in column.

In horse artillery.

The interval between the carriages is 17 yards.

The distance between the lines of pieces, detachments, and caissons is 2 yards.

The detachments are 2 yards in rear of their pieces.

In both kinds of artillery, these arrangements for the line are the same whether the pieces or caissons lead.

ORDER IN BATTERY.

(PLATE 29.) The order in battery is that in which the pieces are prepared for firing; the pieces, limbers, and caissons being turned towards the enemy, and formed in three parallel lines.

The captain is generally on the left of the chief of the centre section; but he may go wherever his presence is required.

Each chief of section is habitually in the centre of his section, half way between the lines of pieces and limbers.

The chief of the line of caissons is opposite the centre, 4 yards in rear of the line of caissons.

Each chief of piece is outside the file on the left of his piece; but near it, and opposite the middle of the trail handspike. During the real execution of the firings, he habitually dismounts and gives the reins of his horse to the driver of the wheel horses of the limber, and takes his place on the right or left of the piece, in such position as will best enable him to observe the effect of the shot.

Each chief of caisson is on the left, and 4 yards in rear of the limber of the piece. In horse artillery, he gives the reins of his horse to the driver of the wheel horses of the caisson.

The trumpeters are near the captain. The guidon is on the flank of the line of caissons.

In mounted batteries.

The interval between the pieces is 14 yards.

The distance between the lines of pieces and limbers is 6 yards, measuring from the end of the handspike to the heads of the leading horses.

The distance between the lines of limbers and caissons is 11 yards, measuring from the rear of the limbers to the heads of the leading horses of the caissons.

The cannoneers are at their posts.

In horse artillery.

The interval between the pieces is 17 yards.

The distance between the lines of pieces and limbers is 6 yards; measured as before.

The distance between the lines of limbers and caissons is 11 yards; measured as before.

The cannoneers are at their posts.

The detachments of horses are 4 yards in rear of the limbers.

The regular formation in battery should be always preserved in the manœuvres. But on the field of battle the front would be commonly more extended; the pieces being posted so as to obtain the greatest advantage from the nature of the ground, and the caissons sheltered as much as possible.

When the battery retires firing, the horses and drivers in both kinds of artillery remain faced to the rear, after the first retrograde movement, that they may be ready to continue it.

REMARKS ON THE FORMATIONS OF THE BATTERY.

During the manœuvres the captain is followed by the trumpeters, who must not leave him. On receiving an order from the captain for that purpose, they take the places assigned them in the order in line.

The guidon takes the place assigned him in the order *in column*, *in line*, or *in battery*, unless otherwise instructed by the captain, who directs him to take such position as he may think necessary.

The *double column* is a particular case of formation in column with a front of two pieces. It is formed on the centre section as head of the column; each of the other sections being in column of pieces in rear. When the battery contains four or eight pieces, the double column is formed upon the two central pieces as before.

When the caissons are detached, which is frequently the case with horse artillery, and sometimes with mounted batteries, the intervals and distances between the pieces for manœuvring will be the same as though the caissons were present; so that the necessary ground for wheeling into line, etc., may be preserved.

Explanation of the signs, in the plates.

	<i>Original Position.</i>	<i>Intermediate Position.</i>	<i>Final Position.</i>
<i>Piece drawn by six horses.</i>			
<i>Caisson drawn by six horses.</i>			
<i>Limber drawn by six horses.</i>			
<i>Piece in battery with its hand spike</i>			
<i>Detachment horses in charge of the horse holders.</i>			
<i>Gun detachment</i> {	<i>Horse Artillery.</i>		
	<i>Mounted Battery.</i>	:::	:::
<i>Captain commanding the battery.</i>			
<i>Lieut. commanding a section.</i>			
<i>Chief of the line of caissons.</i>			
<i>Chief of piece, horse artillery.</i>			
<i>Chief of piece, mounted battery.</i>			
<i>Chief of caisson horse artillery.</i>			
<i>Chief of caisson mounted battery.</i>			
<i>Horse not mounted</i> {	<i>Chief of piece.</i>		
	<i>Chief of caisson.</i>		
<i>Cannoneer at his post.</i>			
<i>Bugler or trumpeter.</i>			
<i>Chief of piece dismounted & at his post.</i>			

..... Indicates the front of a line of carriages or of a detachment in an original, intermediate, or final position, or in a change of direction.

..... Indicates an intermediate position.

The direction in which the plates should be seen.

Scale of Yards.

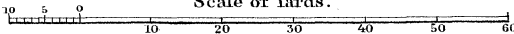

Passage of Carriages.
Horse Artillery.

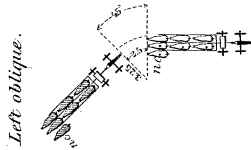
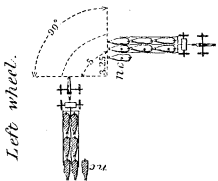
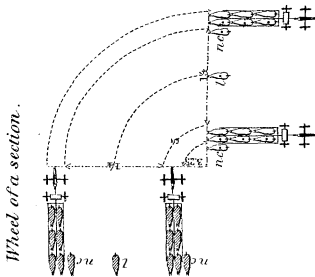
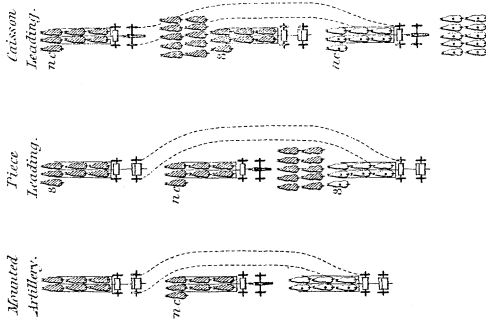

Counter-march.

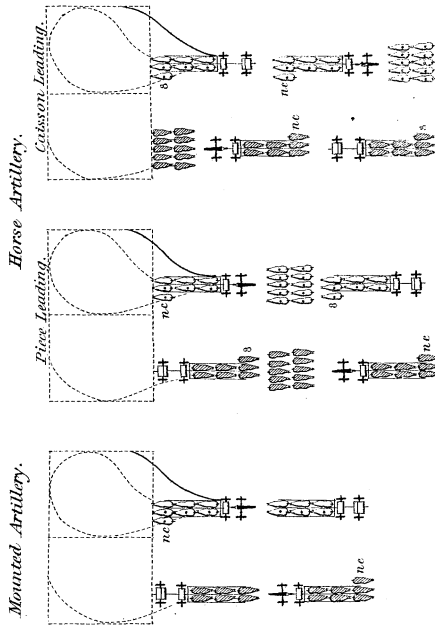

Left about.

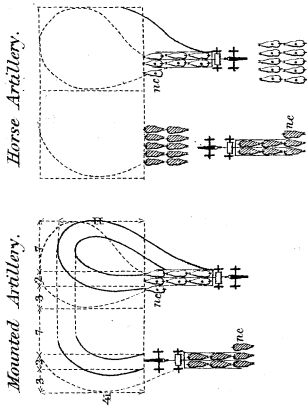

Note. The trunks of the timber wheels are indicated by full lines, the track of the off-leader by broken lines.

Order in Column

Mounted Artillery

Horse Artillery

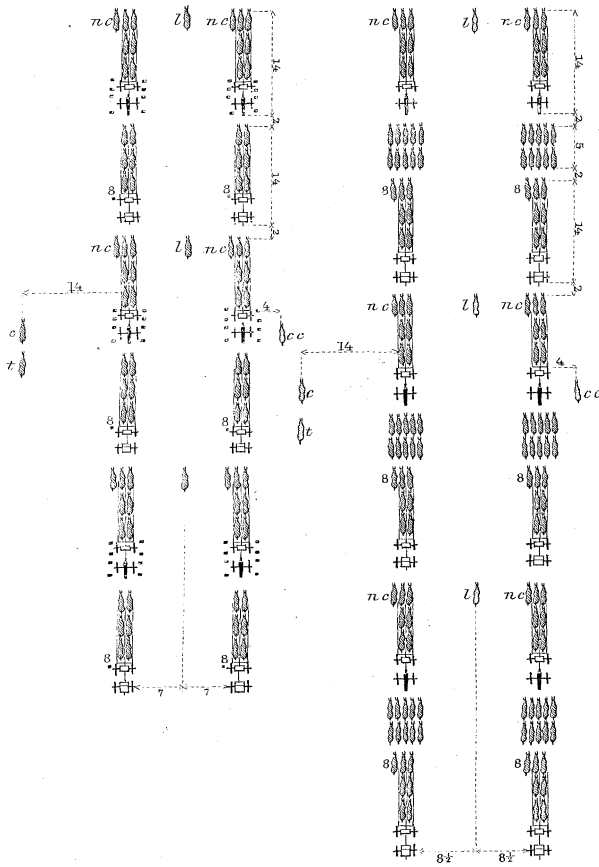

Order in Line
Mounted Battery

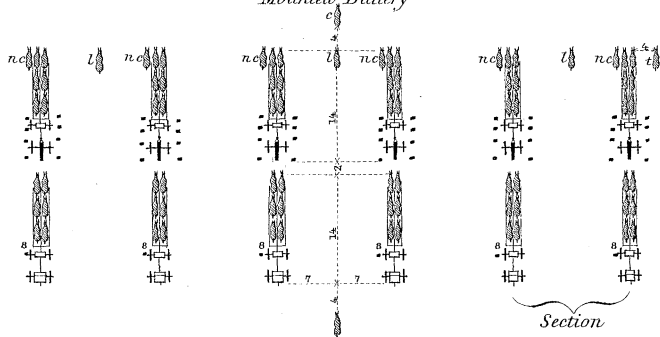

Order in Line
Horse Artillery

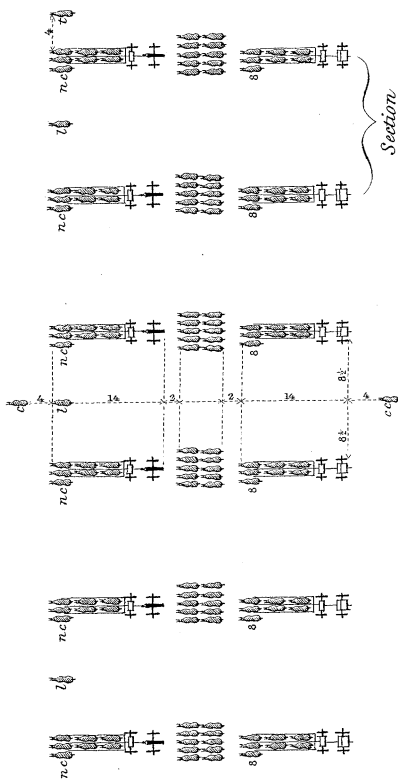

Mounted Artillery.

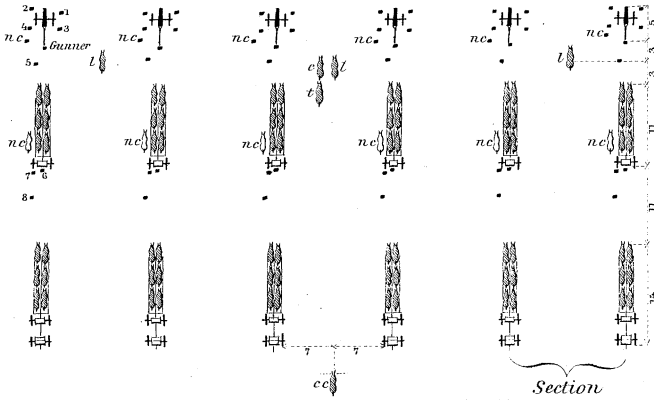

Order in Battery

Horse Artillery

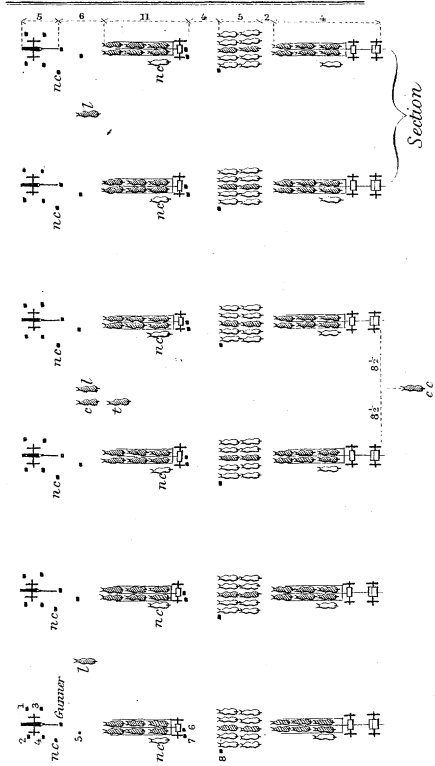

Batteries should be practised in this kind of manœuvring accordingly.

MEASURES OF THE ELEMENTS COMPOSING A BATTERY, AND OF ITS FORMATIONS.

480. The measures given in the three orders of the battery, and those which will be given hereafter, result from the dimensions of the different elements embraced. Those dimensions are given in the following table.

The numbers adopted, having been chosen to avoid fractions, will be found to differ slightly from the exact measures. But as it is extremely difficult, and not very important, to secure precision in the manœuvres, the difference is of little consequence.

	Depth.	Front.
	<i>yards.</i>	<i>yards.</i>
Pieces drawn by six horses.....	14	2
Caisson drawn by six horses.....	14	2
Limber drawn by six horses.....	11	2
Piece in battery with handspike.....	5	2
Detachment of horse cannoners.....	5	5

	Mounted battery.		Horse artillery.	
	Depth.	Front.	Depth.	Front.
	<i>yds.</i>	<i>yds.</i>	<i>yds.</i>	<i>yds.</i>
Column of sections.....	94	18	115	21
Line of battle.....	30	82	37	97
Line in battery.....	47	82	47	97
Section in line.....	30	18	37	21
Section in battery.....	47	18	47	21

MANNING THE BATTERY.

481. The gun-detachments and teams, having been properly told off, are marched to the park with the teams in front.

The chiefs of pieces and caissons, when mounted, march with the teams. The whole are conducted to the battery, the teams hitched, and detachments posted, as prescribed in the school of the section.

As soon as the teams are hitched and cannoneers posted, a minute inspection is made by the chiefs of pieces, who report to the chiefs of sections, and a similar inspection is made by the chiefs of sections, who report to the captain.

The officers, after reporting, will draw their sabres without waiting for a command to that effect. The chiefs of pieces will draw theirs on an intimation from the captain.

ARTICLE SECOND.

MOVEMENTS IN COLUMN.

TO UNPARK.

482. EVERYTHING being prepared for manœuvring, if the captain wishes to unpark by the right, he commands :

1. *By piece—from the right—front into column.*
2. MARCH.

At the command MARCH, the right piece, followed by its caisson, marches direct to the front, and the captain indicates the direction it should take. The other pieces and caissons follow the movement of the right piece, each so regulating its march by that which precedes it as to march in the same direction and 2 yards behind. Each chief of section directs the march of his carriages, which are so conducted by their chiefs as to enter the column by the most simple movement. The column of pieces is thus formed with a distance of 2 yards between the carriages; and in horse artillery with the same distance between the carriages and detachments.

The captain goes wherever his duty may require, but generally remains on the left flank, opposite the centre of the column.

The chief of the leading section places himself near the chief of the leading piece, and on his left; the other chiefs of sections 4 yards from the left flank, abreast the centres of their respective sections.

The chief of the line of caisson is opposite the centre of the column and 4 yards from the right flank.

Each chief of piece and caisson, when mounted, is near his leading driver on the left.

The trumpeters are near the captain.

The guidon is near the chief of the leading piece, on his left.

When the battery is parked with the caissons in front, the captain causes it to unpark by the right by the same commands; the movements being executed in the same manner.

The battery may be unparked by the left according to the same principles, and by inverse means. The commands are:

1. *By piece—from the left—front into column.*
2. MARCH.

483. The column of pieces is not to be considered a column of manœuvre. It will be changed into a column of sections as soon as the nature of the ground will permit. But the exigencies of service sometimes require that formations into line and battery should be made directly from the column of pieces. In such cases, the principles and commands laid down for similar formations from the column of sections will govern. In the formations to the right or left, the pieces must close up, and wheel successively when opposite their proper places.

TO HALT.

484. To halt the battery, when marching in column of pieces, the captain commands:

1. *Column.*
2. HALT.

At the second command, repeated by the chiefs of sections, all the carriages are immediately halted.

CHANGE OF GAIT.

485. The changes of gait, in column of pieces, are executed by the following commands from the captain:

To pass from the walk to a trot.

1. *Trot.*
2. MARCH.

To pass from the trot to a walk.

1. *Walk.*
2. MARCH.

At the first command, repeated by the chiefs of sections, all the drivers and others on horseback prepare to change the gait; and at the second, repeated in like manner, they pass at once to the gait indicated by the first command.

TO FORM SECTIONS.

486. When the battery is marching at a walk in column of pieces, to form sections at the same gait by gaining ground to the left, the captain commands:

1. *Form sections—left oblique.*
2. MARCH.
3. *Guide right.*

(PLATE 30.) The chief of the leading section repeats the commands, *Form section—left oblique—MARCH—Guide right*, in succession after the captain, which are executed as prescribed in No. 450.

The other sections continue to march in column of pieces, and are formed successively by their chiefs; each commanding, *Form section—left oblique*, in time to command MARCH, when the leading carriage of his section has arrived within 5 yards of its distance. The chief of section then commands: *Guide right*.

When the column of pieces is marching at a trot, the formation is executed according to the same principles and by the same commands. But the leading carriages, instead of advancing 5 yards and halting as before, pass to a walk as soon as the command MARCH is repeated by the chief of section. The other sections continue to march at a trot, and execute the movement at that gait; the two leading carriages of each section passing to a walk at the command MARCH, which must be given when they have closed to their proper distance.

When the column of pieces is at a halt, the formation is executed as prescribed for the column at a walk. In this case the carriages all move at the command MARCH, and the leading ones halt after advancing 5 yards.

When the column of pieces is marching at a walk, to form

sections at a trot, gaining ground to the left, the captain commands:

1. *Form sections—left oblique—trot.*
2. MARCH.
3. *Guide right.*

The chief of the leading section repeats the commands, *Form section—left oblique—trot—MARCH—Guide right*, in succession, after the captain.

At the first command, the chiefs of the other sections command: *Trot*; and at the second, which they repeat, their sections commence the trot.

The chiefs of the second and third sections command, *Form section—left oblique*, in time to command MARCH, when the leading carriage of each section has nearly gained its distance. The leading carriage then resumes the walk, and the chief of section commands: *Guide right*.

The chiefs of sections superintend their carriages, and take the posts assigned them in the order in column as soon as their sections are formed.

Sections are formed by gaining ground to the right according to the same principles, and by inverse means. The commands are: *Form sections—right oblique—MARCH—Guide left*; or *Form sections—right oblique—trot—MARCH—Guide left*.

THE BATTERY BEING IN COLUMN OF PIECES, TO FORM THE CAISSONS ON THE FLANK.

487. When the battery is in column of pieces with the caissons in rear, to form the pieces and caissons into separate columns, as in the flank march of a battery in line, the captain commands:

1. *Caissons left, (or Caissons left—trot.)*
2. MARCH.
3. *Guide right.*

These commands are repeated by the chiefs of sections, the caissons oblique at once to the left, gain the interval of 14 yards, and place themselves opposite their pieces; the pieces closing

upon each other at the same time to the usual distance. The gait is regulated as in the formation of sections; and when the movement is performed at a walk, the leading carriage halts after advancing its own length.

The chiefs of sections take their places as in column of sections.

The caissons are formed on the right according to the same principles and by inverse means.

When the pieces are in rear, they are formed on the right or left of their caissons in the same manner and by corresponding commands.

TO MARCH IN COLUMN.

488. The battery being in column at a halt, to advance, the captain commands:

1. *Column—forward.*
2. MARCH.
3. *Guide left (or right.)*

The commands, *forward—MARCH—Guide left (or right,)* are repeated by the chiefs of sections. At the command MARCH, all the carriages advance, the guide maintains the direction, and the carriages, as well as the detachments of horse cannoneers, preserve their intervals and distances.

TO HALT THE COLUMN.

489. The column is halted as in No. 416.

TO CHANGE THE GAIT.

490. The gaits are changed as in No. 424.

TO MARCH BY A FLANK.

491. The battery being in column, in march or at a halt, to gain ground to the left, the captain commands:

1. *Column—by the left flank.*
2. MARCH.

(PLATE 31.) The commands, *By the left flank—MARCH,* are repeated by the chiefs of sections. At the command MARCH, each

carriage wheels at once to the left, and when the wheel is nearly completed, the captain commands :

1. FORWARD.
2. *Guide right.*

These commands are repeated by the chiefs of sections. At the command FORWARD, all the carriages march direct to the front.

The line is regularly established, and the carriages aligned in each rank, with their distances of 2 and intervals of 14 yards. The chiefs of sections take their places between the leading carriages as in line.

To cause the battery to resume its original direction, the captain commands :

1. *Battery—by the right flank.*
2. MARCH.
3. FORWARD.
4. *Guide left.*

The commands, *By the right flank*—MARCH—FORWARD—*Guide left*, are repeated and executed according to the principles before described.

After the flank march, to march the battery in a direction opposite to the original one, the captain commands :

1. *Battery—by the left flank.*
2. MARCH.
3. FORWARD.
4. *Guide right.*

(PLATE 32.) In horse artillery, the flank march is executed according to the same principles, and by the same commands. The carriages and detachments conform to what is prescribed in No. 454.

When the intervals between the carriages of the same section are 21 yards, those between the sections will be 14 yards; when the intervals in the sections are 14 yards, those between the sections will be 21 yards.

The flank march, to gain ground to the right, is executed according to the same principles, and by inverse means.

In each case the captain and the chief of the line of caissons change their direction to the left or right, and conform to the movements of the battery.

OBLIQUE MARCH.

492. The battery being in column, in march, or at a halt, to cause it to march obliquely to gain ground to the front and left, the captain commands:

1. *Column—left oblique.*

2. MARCH.

(PLATE 33.) The chiefs of sections repeat the commands, *Left oblique—MARCH*, after the captain. These commands are executed as in No. 455.

The guide of the leading section is the guide of the column.

The officers conform to the movement and preserve their relative positions.

To resume the original direction, the captain commands:

FORWARD.

This command is repeated by the chiefs of sections, and the carriages resume the original direction by obliquing to the right.

If the captain wishes to halt the column for the purpose of rectifying its alignments, intervals, or obliquity, he commands:

1. *Column.* 2. HALT.

And to resume the march in the oblique direction:

1. *Column.* 2. MARCH.

The commands, HALT—MARCH, are repeated by the chiefs of sections.

(PLATE 34.) In horse artillery, the carriages oblique to the left according to the principles prescribed for mounted artillery. They also form ranks whose fronts are parallel to the original front of the column.

PASSAGE OF CARRIAGES IN COLUMN.

493. When the battery is marching in column, to change the relative positions of the front and rear ranks, without altering the gait, the captain commands :

1. *Pieces, pass your caissons, (or Caissons, pass your pieces.)*
2. MARCH.

These commands are repeated by the chiefs of sections ; and at the command MARCH, they are executed as prescribed in No. 460.

To continue the march without halting the carriages of the rear rank, the captain commands : FORWARD, when the passage is nearly completed, and the command is repeated by the chiefs of section.

When the column is marching at a trot, the passage is executed according to the same principles and by the same commands, except that the carriages of the front rank move at a walk instead of halting at the command MARCH. The carriages of the rear rank execute the passage at a trot, and then change the gait to a walk.

When the column is at a halt, the passage is executed according to the same principles and by the same commands. If the captain wishes to put the column in march immediately after the movement, he commands : FORWARD, when the passage is about being completed, and then, *Guide left (or right.)* These commands are repeated by the chiefs of sections.

When the column is marching at a walk, to execute the passage at a trot, the captain commands :

1. *Pieces, pass your caissons—trot, (or Caissons, pass your pieces—trot.)*
2. MARCH.

These commands are repeated by the chiefs of sections. At the command MARCH, the carriages of the front rank in each section continue to march at a walk. Those of the rear rank execute the passage at a trot, and resume the walk as soon as the passage is completed.

ABOUT IN COLUMN.

494. The battery being in column, in march, or at a halt, to face it to the rear, the captain commands:

1. *Pieces and caissons—left about.*
2. MARCH.

These commands are repeated by the chiefs of sections; and at the second, all the carriages execute the about. When the movement is about being completed, the captain commands: *Column—HALT*; or *FORWARD—Guide right (or left)*; the commands, *HALT*, or *FORWARD—Guide right (or left)*, are repeated by the chiefs of sections.

COUNTERMARCH IN COLUMN.

95. The battery being in column, in march, or at a halt, to execute the countermarch in each section, the captain commands:

1. *Countermarch.*
2. MARCH.

These commands are repeated by the chiefs of sections, and at the second, each piece and its caisson execute the countermarch. When the movement is about being completed, the captain commands: *Column—HALT*; or *FORWARD—Guide right or (left)*.

These commands are repeated as in the preceding paragraph.

TO CHANGE DIRECTION IN COLUMN.

496. The battery being in column, in march, or at a halt, to cause it to change direction to the left, the captain commands:

Head of column to the left.

(PLATE 35.) The chief of the leading section commands: *Left wheel—MARCH*; and afterwards: *FORWARD*. These commands are executed as prescribed in No. 453.

Each of the other sections, on arriving at the point where the first wheeled, executes the same movement, and by the same commands from its chief.

Each chief of section must give the command *Left wheel* in

time to command MARCH, when the heads of his leaders are 3.25 yards from the wheeling point. And the command FORWARD must be given as soon as the leading pivot carriage has entered the new direction.

The change of direction to the right is executed according to the same principles, and by inverse means.

An oblique change of direction is executed according to the same principles, by the command :

Head of column—left (or right) half-wheel.

The chiefs of sections command, successively: *Left (or right) half-wheel—MARCH—FORWARD*; the command FORWARD being given, in this case, when the leading pivot carriage of each section is about finishing the left or right oblique.

TO DIMINISH THE FRONT OF A COLUMN ON THE MARCH.

497. The battery marching at a walk in column of sections, to form column of pieces from the right, at that gait, the captain commands :

1. *By the right—break sections.*
2. MARCH.

(PLATE 30.) The chief of the leading section commands, successively, after the captain: *By the right—break section—MARCH*. At the command MARCH, the movement is executed as prescribed in No. 461.

The other sections are broken in succession by the same commands from their chiefs; the command MARCH being given when the wheel horses of the left carriages of the next preceding section enter the right oblique.

The battery marching at a walk in column of sections, to form column of pieces from the right at a trot, the captain commands :

1. *By the right—break sections—trot.*
2. MARCH.

The chief of the leading section commands, successively, after the captain: *By the right—break section—trot—MARCH*; and

To form Sections

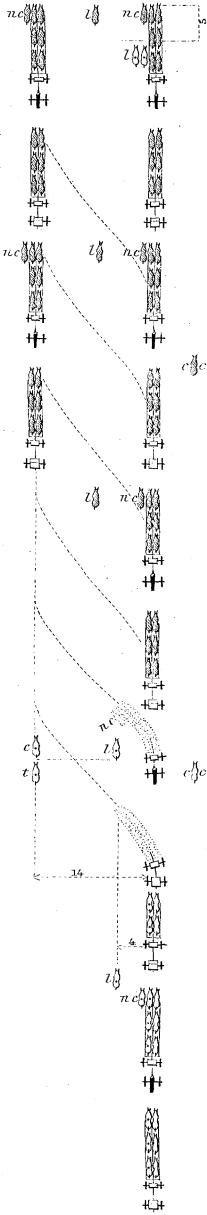

To break Sections

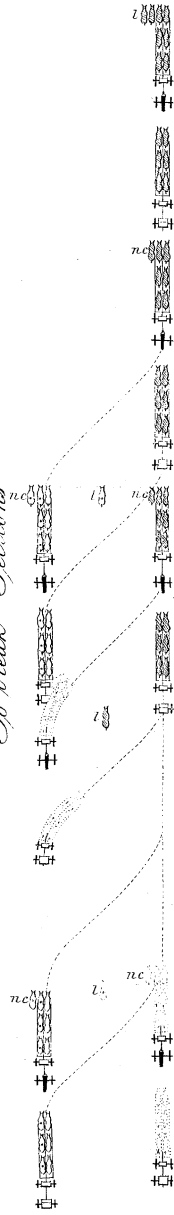

To march to the left flank

Mounted Artillery

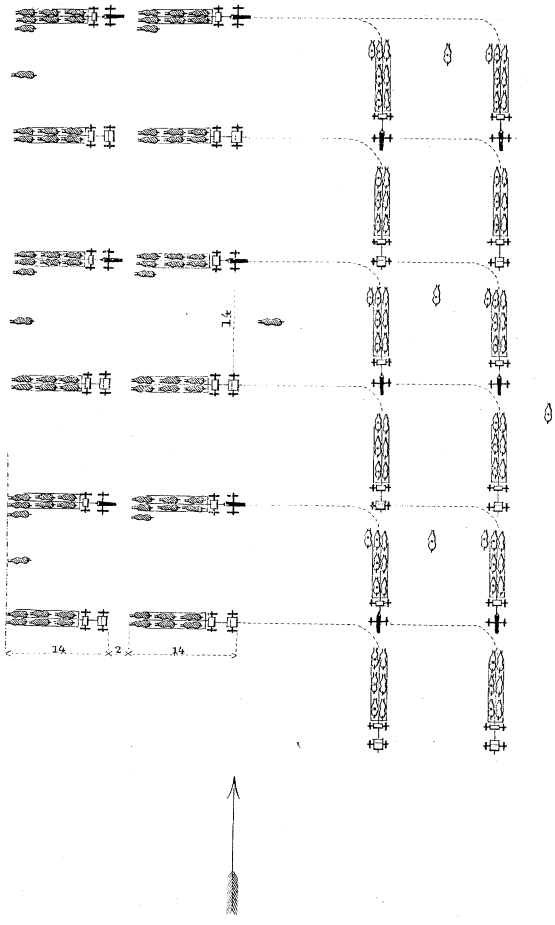

To march to the left flank

Horse Artillery

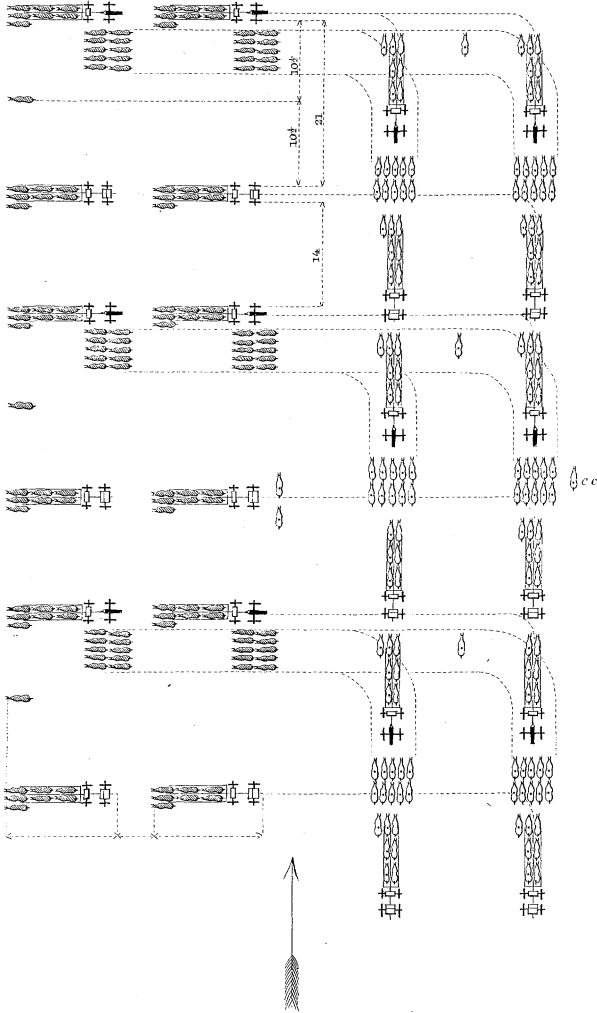

The oblique march

Mounted Battery

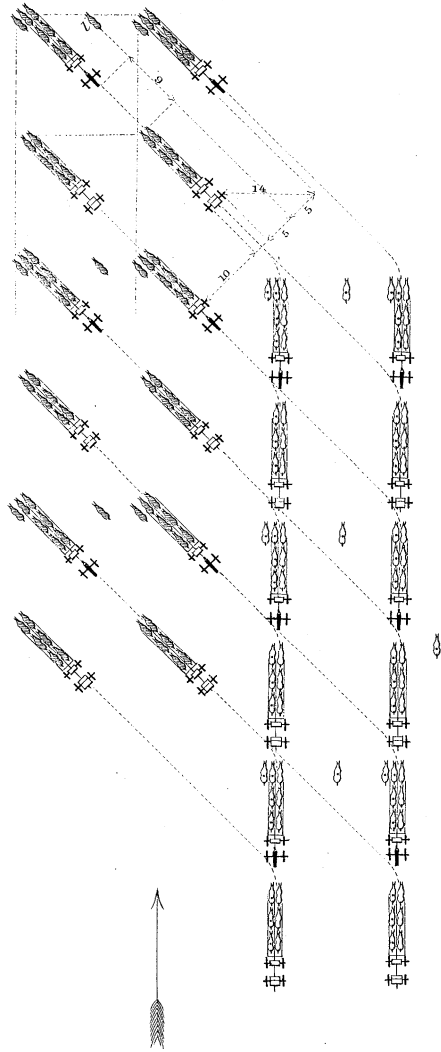

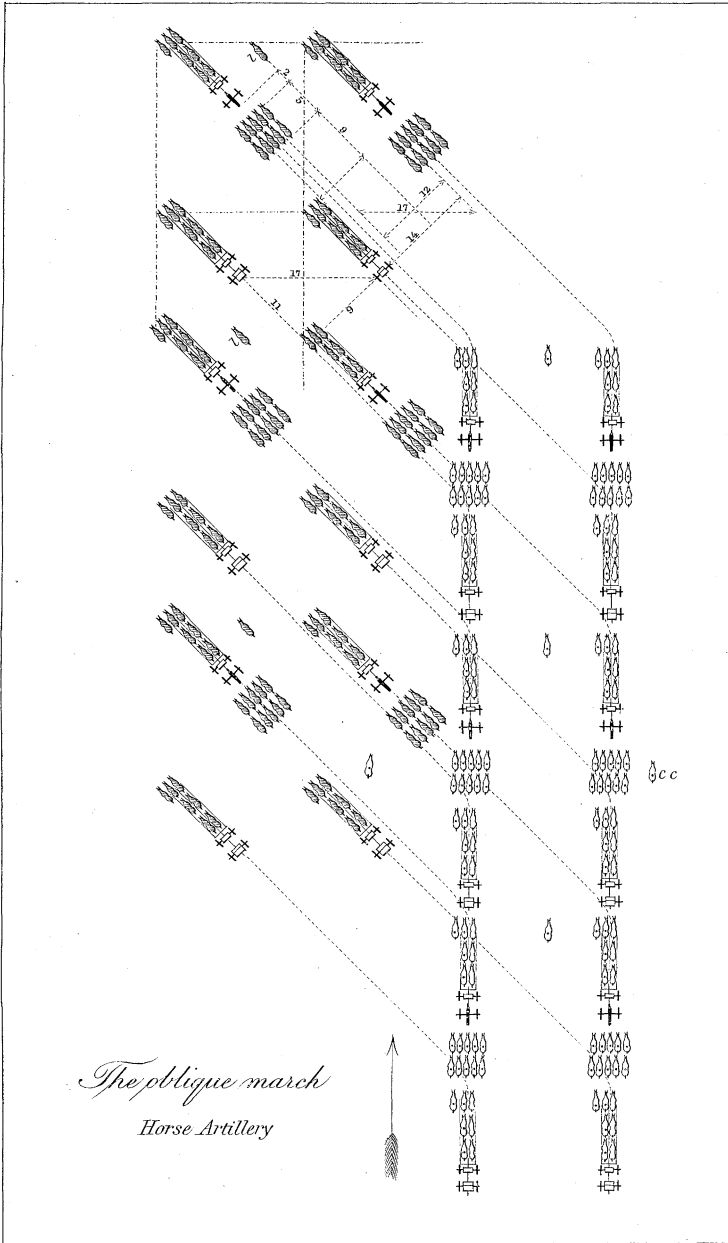

Change of direction to the left.

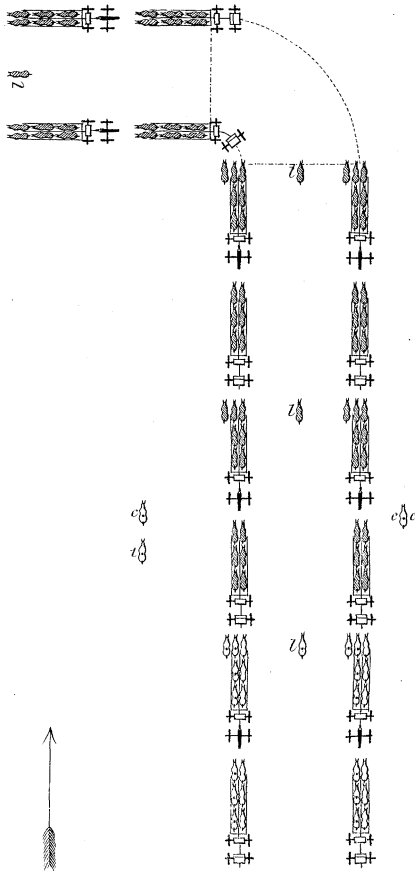

the right carriages of the leading section move forward at a moderate trot. The left carriages of the same section commence the trot on obliquing to enter the column.

The other sections are broken successively by the same commands from their chiefs; and the carriages are regulated by each other, as in breaking sections at a walk.

This formation is executed from the left according to the same principles, and by inverse means.

IN COLUMN WITH THE CAISSONS ON THE FLANK, TO REPLACE THEM IN FRONT OR REAR.

498. The battery being in column, with the caissons on the flank, to re-establish them in rear of their pieces, the captain commands:

1. *Caissons, rear, (or Caissons, rear—trot.)*

2. MARCH.

Each chief of section repeats the commands in time to command MARCH, when the leading piece of his section is to commence the movement; and they are executed as prescribed in No. 463.

TO FORM THE PARK.

499. The battery being in column of pieces, and near the ground on which it is to be parked, will be formed by the commands, and according to the principles, prescribed in No. 464. Each chief of section directs the march of his carriages, and each carriage is conducted to its place in park by its particular chief. When the nature of the ground requires, the detachments are ordered to leave their pieces successively, when they are about entering the park.

ARTICLE THIRD.

TO PASS FROM THE ORDER IN COLUMN TO THE
ORDER IN LINE, AND THE REVERSE.

In all formations in line or column, the movements are the same, whether the pieces or caissons lead.

FORWARD INTO LINE.

500. The battery being in column at a halt, to form it into line on the head of the column, gaining ground to the left, the captain commands:

1. *Forward into line—left oblique.*
2. MARCH.
3. *Guide right.*
4. FRONT.

(PLATE 36.) At the first command, the chief of the leading section commands: *Section—forward*, and those of the other sections, *Section—left oblique*. At the command MARCH, repeated by the chiefs of sections, the leading section moves to the front, and its chief repeats the command for the guide. After advancing 18 yards, or for horse artillery 22, he commands: *Section—HALT—Right-DRESS*.

Each of the other chiefs of sections repeats the command for the guide, and conducts his section by a left oblique, until by the direct march it may gain its proper interval from the section immediately on its right. He then commands: FORWARD, and when within four yards of the line, *Section—HALT—Right-DRESS*.

When the battery is aligned, the captain commands: FRONT.

Forward into line.

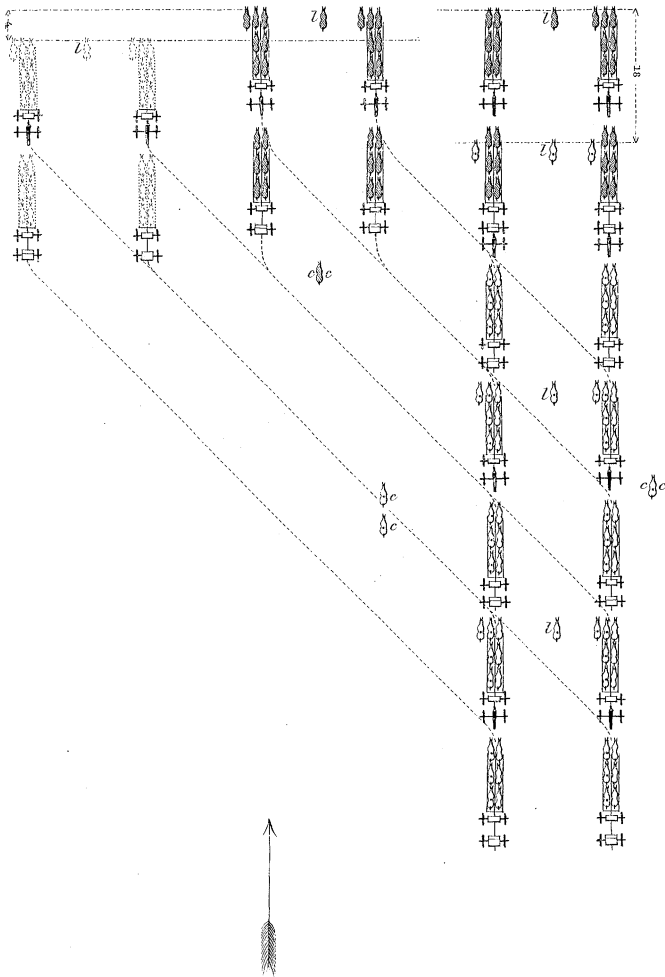

The movement is executed on the opposite flank according to the same principles, and by inverse means.

In this case the commands are: *Forward into line—right oblique—MARCH—Guide left—FRONT.*

The formation forward into line, by a right or left oblique, is executed in a similar manner when the column is in march. In this case the chief of the leading section gives no command except for the guide, until he has advanced the distance before prescribed. He then halts his section as before.

TO FORM LINE FACED TO THE REAR.

501. The battery being in column at a halt, to form it into line faced to the rear, on the head of the column gaining ground to the left, the captain commands:

1. *Into line faced to the rear—left oblique.*
2. MARCH.
3. *Guide right.*
4. FRONT.

(PLATE 37.) At the first command, the chief of the leading section commands: *Section—forward*; and those of the other sections: *Section—left oblique*. At the command MARCH, repeated by the chiefs of sections, the movement is executed as in No. 500, with the exception of the alignment. When the leading section has advanced 18 yards, or for horse artillery 22, it is halted by its chief until the centre section arrives upon the same line. He then commands: *Countermarch—MARCH*; and when the countermarch is nearly completed, *Section—HALT—Left-DRESS*.

The centre section is halted upon the line in like manner until the left section comes up, and is then countermarched and aligned by the same commands.

When the left section arrives upon the line, it is countermarched before halting, and then aligned like the rest.

When the centre and left sections are countermarched, the commands, *HALT—Left-DRESS*, should be given, if possible,

when they are 4 yards in rear of the line on which the leading section is established.

When the battery is aligned, the captain commands: **FRONT**.

The movement is executed on the opposite flank according to the same principles, and by inverse means. In this case, the commands are: *Into line faced to the rear—right oblique—MARCH—Guide left—FRONT*.

The formation into line faced to the rear, by a right or left oblique, is executed in a similar manner when the column is in march. In this case, as the leading section is already in motion, its chief only repeats the command for the guide, as in No. 500.

The countermarch of sections will be executed at the gait ordered for the rear of the column.

TO FORM LINE TO THE RIGHT OR LEFT.

502. The battery being in column, in march, or at a halt, to form it into line to the left, the captain commands:

1. *Left into line wheel.*
2. **MARCH.**
3. *Battery—HALT.*
4. *Left—DRESS.*
5. **FRONT.**

(PLATE 38.) At the first command, the chiefs of sections command: *Section—left wheel*; and at the second, which they repeat, all the sections wheel to the left. Each chief of section commands: *Forward—Guide left*, as soon as his leading pivot carriage has taken the new direction.

When the rear carriages have completed the wheel, and the sections are in line, the captain commands: *Battery—HALT—Left—DRESS.*

The commands, **HALT—Left—DRESS**, are repeated by the chiefs of sections, and when the alignment is completed, the captain commands: **FRONT**.

The battery is formed into line to the right according to the same principles, and by inverse means.

To the left into line.

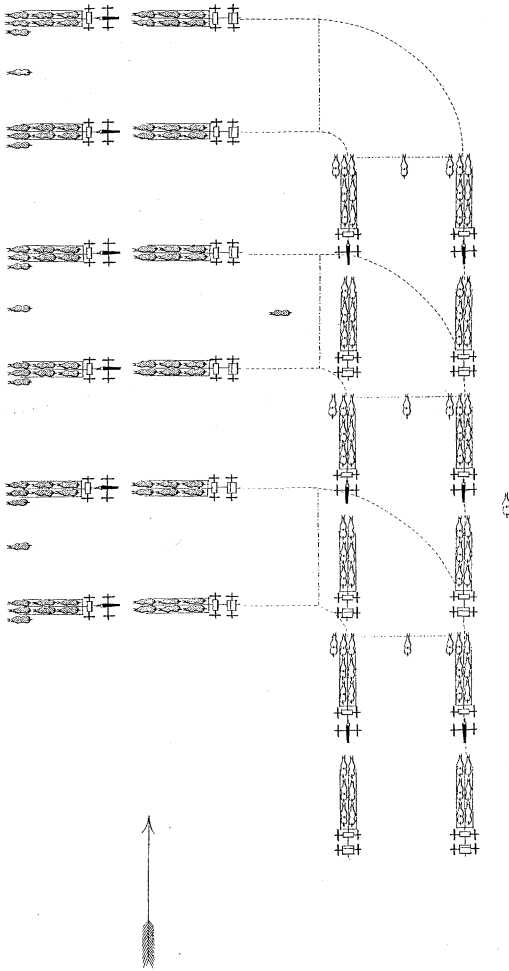

On the right, into line.

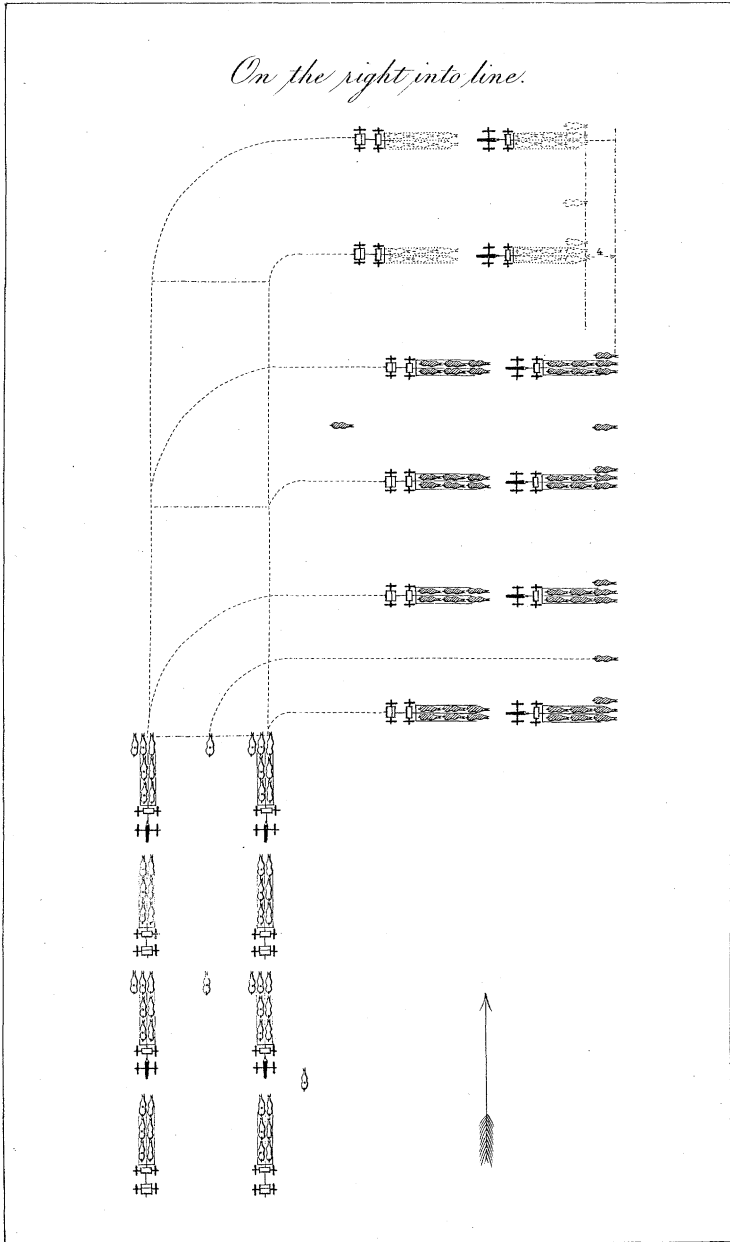

TO FORM LINE ON THE RIGHT OR LEFT.

503. The battery marching in column, to form it into line on the right, the captain commands:

1. *On the right into line.*
2. MARCH.
3. *Guide right.*
4. FRONT.

(PLATE 39.) At the first command, the chief of the leading section commands: *Section—right wheel*; and at the second, which he repeats, the section wheels to the right. As soon as the leading pivot carriage enters the new direction he commands: FORWARD—*Guide right*; and as the section completes the wheel, and unmask the column, he commands: *Section—HALT—Right-DRESS.*

The chiefs of the other sections repeat the command for the guide, and their sections continue to move forward. As each section passes the one preceding it in the formation, its chief establishes it on the line, with the proper interval, by the same commands. The commands, *Section—HALT—Right-DRESS*, are given when the section is 4 yards in rear of the line.

When the battery is aligned, the captain commands: FRONT.

The line is formed on the left according to the same principles, and by inverse means. The commands are: *On the left into line—MARCH—Guide left—FRONT.*

When the column is at a halt, the line is formed on the right or left in the same manner. In this case, the chiefs of the two rear sections command: *Section—forward*, and afterwards repeat the commands, MARCH—*Guide right (or left).*

TO BREAK INTO COLUMN TO THE FRONT.

504. The battery being in line at a halt, to break into column to the front from the right, the captain commands:

1. *By section from the right—front into column.*
2. MARCH.
3. *Guide left.*

(PLATE 40.) At the first command, the chief of the right section commands: *Section—forward*; and those of the other sections: *Section—right oblique*. At the command MARCH, repeated by the chief of the right section, that section moves forward, and its chief repeats the command for the guide.

Each of the other chiefs of sections repeats the commands MARCH—*Guide left*, after the section on his right has commenced the movement, and when the leaders of its rear carriages are in line with him. After obliquing sufficiently to gain the rear of the preceding section, he commands: FORWARD.

To commence the movement at a trot, the captain commands:

1. *By section from the right—front into column—trot.*
2. MARCH.
3. *Guide left.*

At the first command, the chief of the right section commands: *Section—forward—trot*; those of the other sections: *Section—forward*. At the command MARCH, repeated by the chiefs of sections, the right section moves at a trot, and the other sections at a walk, their chiefs adding the command for the guide.

The chiefs of the centre and left sections command: *Section—right oblique—trot*, in time to command MARCH, when the leaders of the rear carriages of the section on their right are opposite to them.

This rule for commencing movements at a trot is general.

The movement is executed from the left according to the same principles, and by inverse means.

TO BREAK INTO COLUMN TO THE REAR.

505. The battery being in line, in march, or at a halt, to break into column to the rear from one of the flanks, the captain executes an about or a countermarch, according to the kind of carriage he may wish in front, then halts the battery, and breaks it into column to the front by the preceding manœuvre.

To break into column to the front.

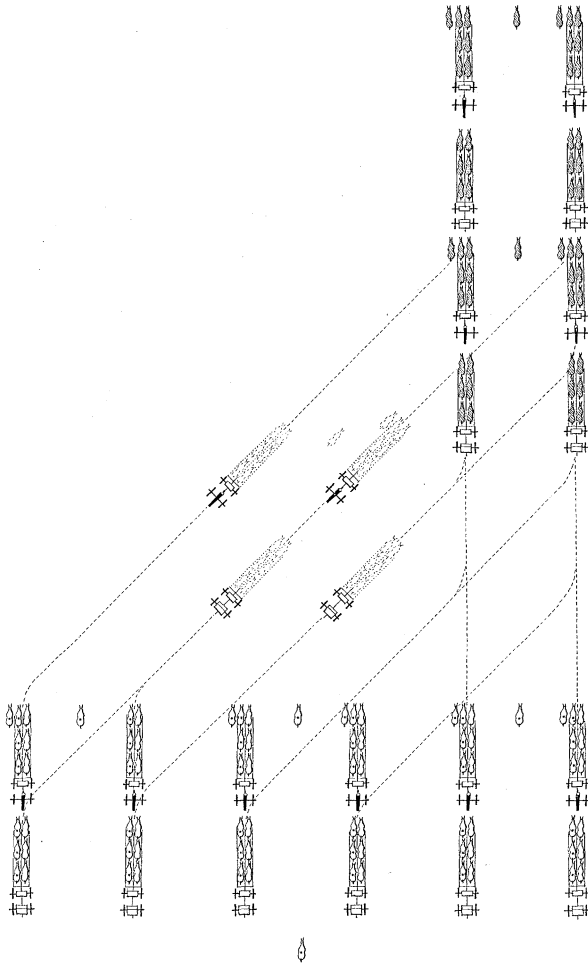

To break into column to the left.

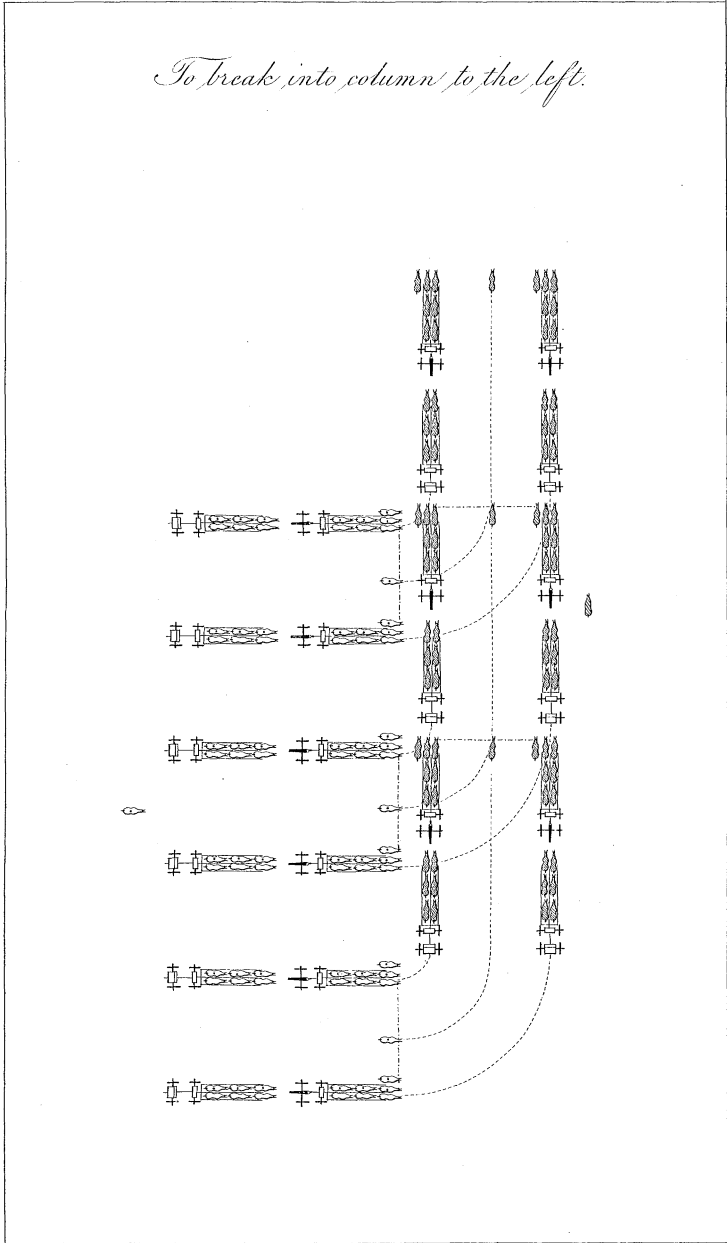

To break from the right, to march to the left.

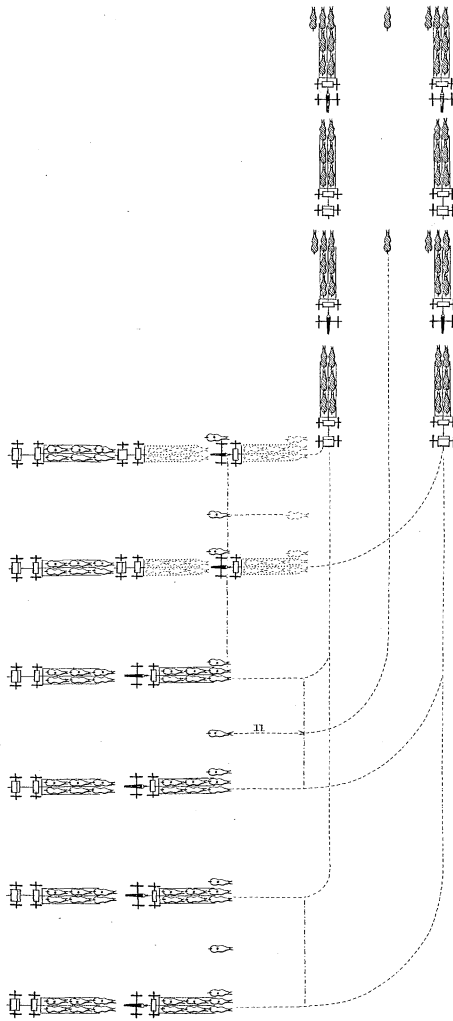

TO BREAK INTO COLUMN TO THE RIGHT OR LEFT.

506. The battery being in line, in march, or at a halt, to break it into column to the left, the captain commands :

1. *By section—left wheel.*
2. MARCH.
3. FORWARD.
4. *Guide left.*

(PLATE 41.) At the first command, the chiefs of sections command: *Section—left wheel*; and at the second, repeated by those chiefs, all the sections wheel to the left. When the wheels are nearly completed, the captain commands: FORWARD—*Guide left*; and the chiefs of sections repeat the commands.

When the column is not to advance, the command, *Column—HALT*, is substituted for FORWARD—*Guide left*.

The battery is broken into column to the right according to the same principles, and by inverse means.

TO BREAK INTO COLUMN TO THE FRONT FROM ONE FLANK,
TO MARCH TOWARDS THE OTHER.

507. The battery being in line at a halt, to break from the right to march to the left, the captain commands :

1. *By section—break from the right—to march to the left.*
2. MARCH.
3. *Guide left.*

(PLATE 42.) At the first command, the chief of the right section commands: *Section—forward*; and at the second, which he repeats, the section moves forward, and he commands: *Guide left*. After advancing 11 yards, he changes the direction to the left by the commands: *Section—left wheel—MARCH—FORWARD*.

Each of the other chiefs of sections commands: *Section—forward*, in time to command MARCH when the limber wheels of the rear carriages in the section preceding his own arrive in front of him. He then conducts the section to the front, changes its direction to the left, and places it in rear of the preceding sec-

tion by the commands already prescribed for the section on the right.

The battery is broken from the left to march to the right according to the same principles, and by inverse means.

TO BREAK INTO COLUMN TO THE REAR FROM ONE FLANK, TO MARCH TOWARDS THE OTHER.

508. The battery being in line at a halt, to break to the rear from one flank to march towards the other, the captain first executes an about or countermarch, according to the kind of carriage he may wish in front. He then halts the battery and executes the preceding manœuvre.

TO BREAK INTO COLUMN TO THE FRONT, WHEN THE BATTERY IS MARCHING IN LINE.

509. The battery marching in line at a walk, to break into column to the front from the right, and at the same gait, the captain commands :

1. *By the right—break into sections.*
2. MARCH.
3. *Guide left.*

The chief of the right section repeats the command for the guide, and his section continues to move at the same gait. At the command MARCH, the other sections are halted by the command, *Section—HALT*, from their chiefs.

The halted sections are put in motion successively by their chiefs; each commanding, *Section—right oblique*, in time to command MARCH, when the leaders of the rear carriages in the section on his right arrive opposite to him. The sections oblique and enter the column as described in No. 504.

When the battery is marching at a trot, the movement is executed according to the same principles. But the sections which halted in the preceding case slacken the gait to a walk at the commands, *Walk—MARCH*, from their chiefs. They again trot and enter the column by the commands, *Section—right oblique—trot—MARCH—FORWARD*.

When the battery is marching in line at a walk, to break into column from the right at a trot, the captain commands:

1. *By the right—break into sections—trot.*
2. MARCH.
3. *Guide left.*

At the first command, the chief of the right section commands: *Trot*; and at the second, which he repeats, the section changes its gait to a trot. He afterwards repeats the command, *Guide left*.

Each of the other sections continues to march at a walk until required to enter the column, when its chief conducts it, as already described, by the commands, *Section—right oblique—trot—MARCH—FORWARD*.

The battery is broken into column from the left according to the same principles, and by inverse means.

TO FORM LINE ADVANCING.

510. When the battery is marching in column at a walk, to form it into line at a trot gaining ground to the left, and continue the march, the captain commands:

1. *Form line advancing—left oblique—trot.*
2. MARCH.
3. *Guide right.*

The chief of the leading section repeats the command for the guide, and his section continues to move at a walk.

At the first command, the chiefs of the other sections command: *Section—left oblique—trot*. The command MARCH is repeated by the same chiefs; and when the oblique movement is commenced, they repeat the command, *Guide right*. Each chief commands: FORWARD, as soon as his section has obliqued sufficiently to the left, and *Walk*, in time to command MARCH, as it arrives on the line.

When the battery is marching in column at a trot, the movement is executed according to the same principles. In this case the captain does not command *Trot*; and the chief of the leading

section commands: *Walk*—MARCH, successively after the first and second commands of the captain. The chiefs of the other sections give the same commands as their sections arrive on the line.

The movement is executed so as to gain ground to the right according to the same principles, and by inverse means.

TO FORM DOUBLE COLUMN ON THE CENTRE SECTION.

511. The battery being in line at a halt, to form double column on the centre section, the captain commands:

1. *Double column on the centre.*
2. MARCH.
3. *Guide right (or left.)*

(PLATE 43.) At the first command, the chief of the centre section commands: *Section—forward*; the chief of the right section: *Section—left oblique*; and the chief of the left section: *Section—right oblique*. At the command MARCH, repeated by the chief of the centre section, that section marches to the front, and its chief repeats the command for the guide.

When the wheel horses in the rear rank of the centre section have passed the leaders in the front rank of the other sections, the chiefs of those sections repeat the command MARCH, and the sections commence the oblique.

When the piece nearest the column is about entering it, in each of these sections, the chief of the right section commands: *By the left—break section—MARCH*; and the chief of the left: *By the right—break section—MARCH*. The right and left sections, without change of gait, then form into columns of pieces in rear of the right and left carriages of the centre section.

The chiefs of the flank sections are careful to make their pieces enter the column at the proper time. When the column is formed they place themselves 4 yards outside of it, the one highest in rank opposite the leaders of his leading carriage, the other opposite the leaders of the front carriage of his rear piece. In these positions they command the pieces abreast of them as sections for the time being.

To form double column.

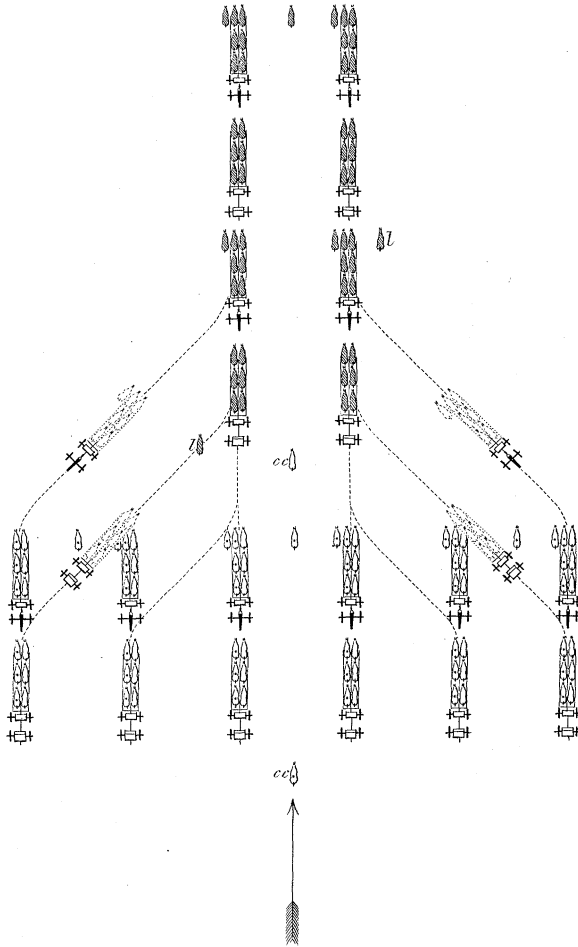

The chief of the line of caissons follows the movement, sees that his carriages do not enter the column too soon, and, when the column is formed, places himself 4 yards in rear of its centre.

When the battery is marching at a walk, to form the double column at the same gait, the captain commands :

1. *Double column on the centre.*
2. MARCH.
3. *Guide right (or left.)*

The chief of the centre section repeats the command for the guide, and the section continues to advance.

At the command MARCH, the other sections are halted by the command, *Section—HALT*, from their chiefs. They are afterwards formed into column by the commands and means prescribed for forming double column from a halt.

When the battery is marching at a trot, the double column is formed according to the same principles. In this case the flank sections pass to a walk, instead of halting as before, and resume the trot, to oblique and enter the column. The commands from their chiefs are : *Walk—MARCH—Section—left (or right) oblique—trot—MARCH*, and, *By the left (or right)—break section—MARCH*.

When the battery is marching at a walk, to form the double column at a trot, the captain commands :

1. *Double column on the centre—trot.*
2. MARCH.
3. *Guide right (or left.)*

At the first command, the chief of the centre section commands : *Trot*. At the second, which he repeats, the section moves forward at a moderate trot, and he repeats the command for the guide.

The flank sections continue to walk until the centre has advanced sufficiently to allow them to oblique, and are then formed into column as already prescribed ; their chiefs commanding : *Section—left (or right) oblique—trot—MARCH* ; and, *By the left (or right)—break section—MARCH*.

If the battery is at a halt, the chief of the centre section commands: *Forward—trot*; and the chiefs of the other sections, *Forward*, after the first command from the captain. At the second, repeated by the chiefs of sections, all move forward, the flank sections at a walk; and the movement is completed as already directed.

To form the double column with a battery of four or of eight pieces, the captain gives the same commands as with a battery of six. In the four-gun battery, the right section is broken into column of pieces by the left, and the left section is broken by the right at the commands of the chiefs of sections, who place themselves on the outer flanks of the column and command the temporary sections, as directed for the flank sections of the battery of six pieces.

In the battery of eight pieces, the double column is formed on the two centre pieces according to the same principles. The flank sections oblique, and form in column of pieces behind the centre sections at the commands of their chiefs, who then take post on the flanks of the column, and command the temporary sections formed from their own, the senior of the two commanding the leading one.

TO DEPLOY THE DOUBLE COLUMN INTO LINE TO THE FRONT.

512. The battery being in double column at a halt, to form it into line to the front, the captain commands:

1. *Forward into line.*
2. MARCH.
3. FRONT.

(PLATE 44.) At the first command, the chief of the centre section commands: *Section—forward*; the chief of the right section: *Section into line—right oblique*; and the chief of the left section: *Section into line—left oblique*. At the command MARCH, repeated by these chiefs, the centre section advances 5 yards, and its chief commands: *Section—HALT—Right (or left) DRESS*.

The flank sections oblique to the right and left; and as their

To deploy the double column into line to the front.

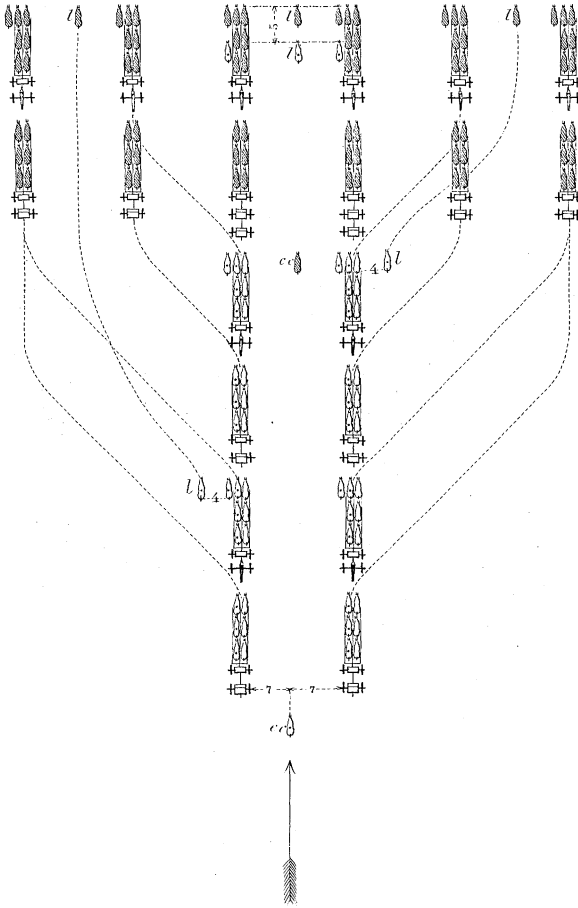

pieces arrive in rear of their proper places on the line, they move forward, halt, and dress towards the centre without command.

As soon as the battery is aligned, the captain commands:
FRONT.

When the column is marching, the movement is executed in the same manner. In this case the chief of the centre section does not command, *Section—forward—MARCH*; but halts and aligns his section after advancing 5 yards.

513. When the column is marching at a trot, to deploy it into line to the front at the same gait, without discontinuing the march, the captain commands:

1. *Form line advancing.*
2. MARCH.
3. *Guide right (or left.)*

At the first command, the chief of the centre section commands: *Walk*; the chief of the right section: *Section into line—right oblique*; and the chief of the left section: *Section into line—left oblique*. At the command MARCH, repeated by these chiefs, the centre section slackens its gait to a walk, and the flank sections deploy. As each piece arrives upon the line, its gait is changed to a walk without command. The movement is executed as in the preceding cases; but when the line is formed it continues to advance; the captain commanding, *Guide right (or left,)* which command is repeated by the chiefs of sections.

When the column is marching at a walk, to deploy it into line to the front at a trot, without discontinuing the march, the captain commands:

1. *Form line advancing—trot.*
2. MARCH.
3. *Guide right (or left.)*

At the first command, the chief of the right section commands: *Section into line—right oblique—trot*; and the chief of the left section: *Section into line—left oblique—trot*. At the command MARCH, repeated by these chiefs, the flank sections deploy at a trot; the centre section continues to march at a walk; and, the

line having been formed as in the preceding case, the captain gives the command for the guide.

When the battery consists of four or eight pieces, the double column is deployed into line to the front by the same commands from the captain as when it consists of six. The chiefs of sections give the same commands as in the other case, and the centre sections are formed as in No. 486. When the line is to be halted, as in forming *forward into line*, the leading chief commands: HALT—*Right* (or *left*) DRESS, as soon as the leading carriages have advanced 5 yards; and the alignment is made upon the central carriages.

TO FORM THE DOUBLE COLUMN INTO LINE TO THE RIGHT
OR LEFT.

514. The battery being in double column at a halt, to form it into line to the right, the captain commands:

1. *To and on the right into line.*
2. MARCH.
3. FRONT.

At the first command, the chief of the leading section commands: *Section—right wheel*; and the other chiefs of sections: *Forward*. At the second, repeated by those chiefs, the leading section wheels to the right, and is established on the line, as in No. 503. The other pieces advance under the direction of their chiefs and of the chiefs of sections, wheel to the right in succession as they arrive opposite their places, establish themselves on the line, and dress upon the pieces already aligned. When the alignment is completed, the captain commands: FRONT.

When the column is marching, the line is formed to the right in the same manner, except that the chiefs of the flank sections omit the commands, *Forward—MARCH*. The line is formed to the left according to the same principles, and by inverse means.

When the battery consists of four or of eight pieces, the double column is deployed into line to the right or left by the same commands from the captain as when it consists of six. In this case,

the leading pieces are wheeled to the right or left, as a section, and established on the line, as in No. 503. For this purpose, the leading chief of section commands: *Right (or left) wheel—MARCH—FORWARD—Guide right—(or left)—HALT—Right (or left) DRESS.* The other pieces move forward, wheel in succession as they arrive opposite their places, and form on the line, as already described.

ARTICLE FOURTH.

MOVEMENTS IN LINE.

TO ADVANCE IN LINE.

515. THE battery being in line at a halt, to cause it to advance, the captain indicates to the guide the points on which he is to march, and commands:

1. *Battery—forward.*
2. MARCH.
3. *Guide right (or left.)*

The commands, *Forward—MARCH—Guide right (or left,)* are repeated by the chiefs of sections. At the command MARCH, all the carriages move forward at a walk, and the chiefs of sections preserve the alignment towards that chief of carriage who serves as *guide of the line*. The guide marches steadily in the given direction, and the chiefs of carriages regulate their intervals and alignment by him.

The carriages of the rear rank follow those in front at their appropriate distance of 2 yards. The chief of the line of caissons superintends the march of the rear rank of carriages, and moves wherever his presence may be necessary for that purpose.

In **horse artillery**, the detachments preserve their alignments, and follow their pieces at the proper distance. They are sometimes upon the flanks, as pointed out in No. 444.

TO HALT THE BATTERY AND ALIGN IT.

516. When the battery is marching in line, to halt and align it, the captain commands:

1. *Battery—HALT.*
2. *Right (or left) DRESS.*
3. FRONT.

Flank march.

Mounted Battery

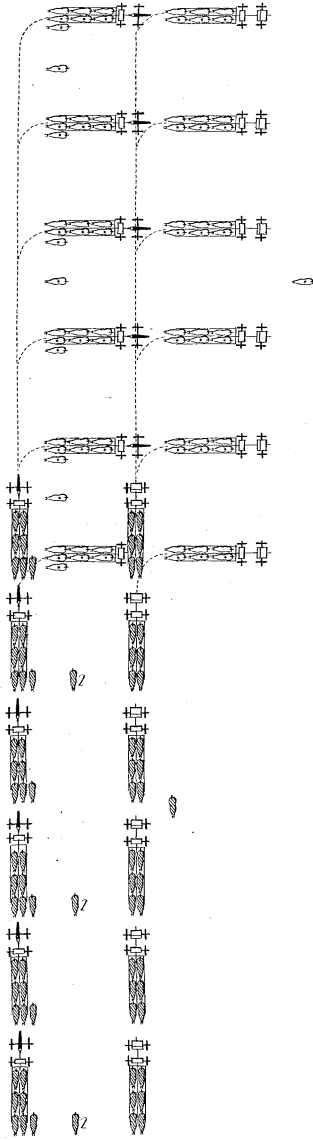

Flank march.

Horse-Artillery

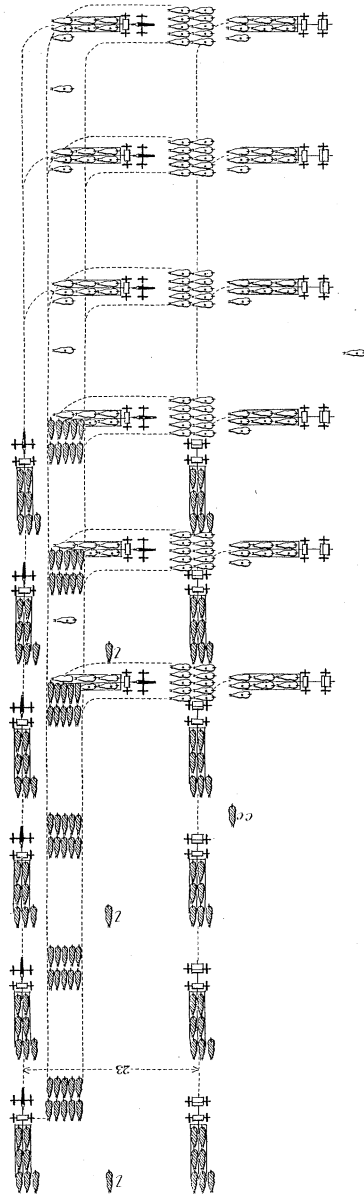

The oblique march.

Mounted Battery

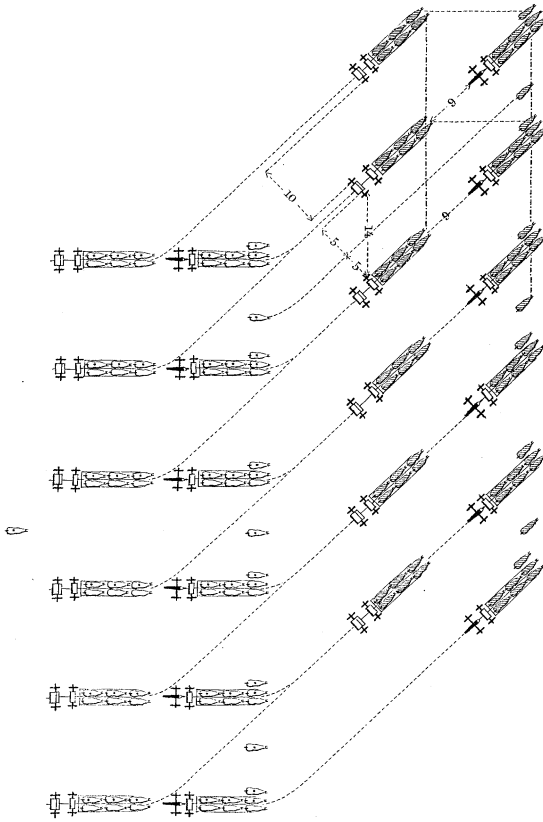

The oblique march.

Horse Artillery

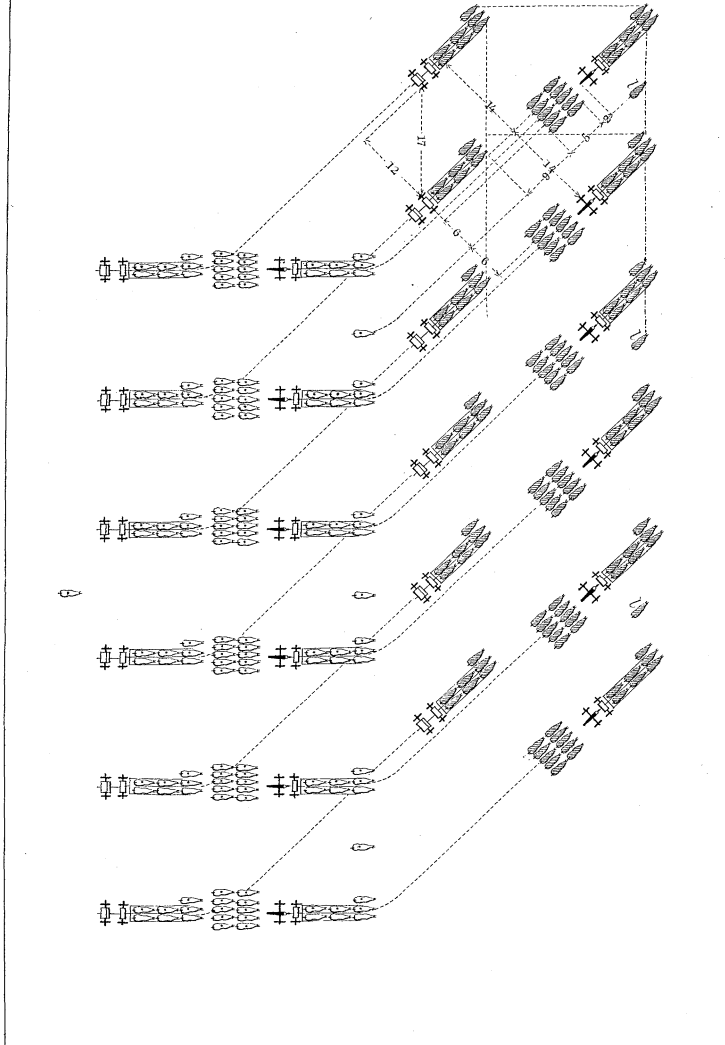

The commands, HALT—*Right (or left) Dress*, are repeated by the chiefs of sections. At the first command, the carriages and detachments halt, and at the second align themselves by the right (or left) in their respective ranks; the carriages dressing by the drivers of their wheel horses. The carriages are placed as squarely on the line as possible, without opening or closing the intervals. The captain superintends the alignment of the front rank of carriages, and the chief of the line of caissons that of the rear; each placing himself for that purpose on the flank of the guide. When the battery is aligned, the captain commands: FRONT.

When the battery is halted, if it cannot be aligned by slight movements, the captain causes one or two carriages from one of the flanks or centre to advance 4 yards, or to a greater distance if necessary, and then causes the alignment to be made by the right, left, or centre, by the command, *Right, Left, or, On the centre—DRESS*. At this command, the carriages and detachments move forward, and align themselves according to the principles just explained; the drivers halting a little in rear of the line, and dressing forward, so as to place the carriages as squarely upon it as possible.

CHANGES OF GAIT.

517. When the battery is marching in line, the changes of gait are effected by the commands and means prescribed in No. 485.

TO MARCH BY A FLANK.

518. (PLATES 45 and 46.) The battery being in line, in march, or at a halt, to cause it to move in the direction of one of its flanks, the captain commands:

1. *Battery—by the right (or left) flank.*

2. MARCH.

And the movement is executed as prescribed in No. 491.

OBLIQUE MARCH.

519. (PLATES 47 and 48.) The battery being in line, in

march, or at a halt, to gain ground to the front and towards one of the flanks, and afterwards resume the direct march, the captain commands: *Battery—right* (or *left*) *oblique*, etc., as in No. 492. The movement is executed as described in that number.

PASSAGE OF CARRIAGES IN LINE.

520. When the battery is in line, the passage of carriages is executed by the commands and means prescribed in No. 460.

ABOUT IN LINE.

521. When the battery is in line, the about is executed by the commands and means prescribed in No. 494, substituting the word *battery* for *column*.

COUNTERMARCH IN LINE.

522. The countermarch of a battery in line is executed by the commands and means prescribed in No. 495, substituting the word *battery* for *column*.

TO CHANGE DIRECTION IN LINE.

523. The battery being in line at a halt, to wheel it to the right, the captain commands:

1. *Battery—right wheel.*
2. MARCH.
3. FORWARD.
4. *Battery—HALT.*
5. *Right-DRESS.*
6. FRONT.

The commands, *Right wheel—MARCH—FORWARD—HALT—Right-DRESS*, are repeated by the chiefs of sections.

(PLATE 49.) At the command MARCH, the pivot carriage moves at a walk, and describes a quadrant (22 yards) of a circle whose radius is 14 yards. The other carriages move at a trot and preserve their intervals from the pivot. They regulate their gaits according to their distances from the pivot, so as to remain

Change of direction in line.

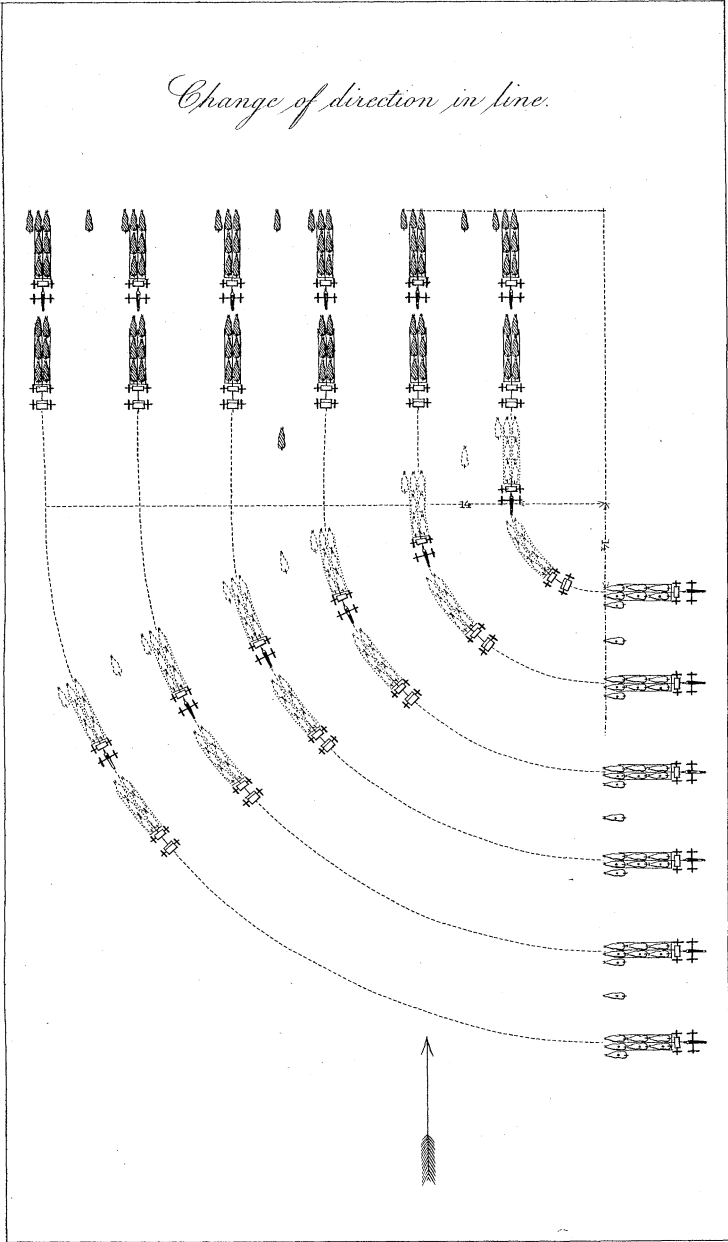

as short a time as possible in rear of the line, without urging their horses injuriously, and so as to arrive upon it in succession. The carriages of the rear rank follow at the proper distance in the tracks of those in front.

At the command FORWARD, which is given when the leading pivot carriage has described its arc of 22 yards, that carriage moves direct to the front; and when the rear pivot carriage is in the new direction, the captain commands: *Battery—HALT—Right-DRESS*. The commands, FORWARD—HALT—*Right-DRESS*, are repeated by the chief of the right section immediately after the captain; and by the other chiefs in time to be applicable to their sections; the pivot carriages halting at the command HALT, and the others halting and dressing towards the pivot as they arrive in succession on the line.

When the battery is aligned, the captain commands: FRONT.

The battery is wheeled to the left according to the same principles, and by inverse means.

524. When the battery is at a halt or marching in line, to wheel it to the right and continue the march, the captain commands:

1. *Battery—right wheel.*
2. MARCH.
3. FORWARD.

The movement is executed as already described, except that the pivot carriage, after wheeling, continues to march in the new direction, and the others conform to its gait and direction as they arrive on the line.

The direction is changed to the left according to the same principles, and by inverse means.

TO CLOSE INTERVALS IN LINE.

525. When the battery is marching in line at a walk or trot, to diminish its intervals, the captain commands:

1. *On right (or left) piece, of ——— section, to ——— yards —close intervals.*
2. MARCH.

(PLATE 50.) The chief of the section designated repeats the command, *On right (or left) piece, to — yards—close intervals*; and the other chiefs of sections command: *Right (or left) to — yards—close intervals*. At the command MARCH, repeated by the same chiefs, the piece designated as the one of direction moves forward at a walk, and the others oblique towards it at a trot. Each obliquing carriage regulates its march by the one next towards the carriage of direction, and, after closing to the prescribed interval, moves forward on the alignment of the directing carriage and slackens the gait to a walk.

As soon as the intervals are closed, the command for the guide is renewed by the captain, and repeated by the chiefs of sections.

When the intervals are to be closed towards one of the flanks, the captain commands:

1. *On right (or left) piece, to — yards—close intervals.*
2. MARCH.

ABOUT OR COUNTERMARCH WITH DIMINISHED INTERVALS.

526. The battery being in line with diminished intervals, in march or at a halt, to execute an about or countermarch, the captain commands:

1. *Pieces and caissons—left about, (or countermarch.)*
2. *Right pieces forward, (or right pieces forward—trot.)*
3. MARCH.

The chiefs of sections repeat these commands. At the second, the right carriages of each section move forward, and as soon as they are disengaged from the line, the captain commands: MARCH. All the carriages execute the required movement at this command, with the gait corresponding to that of the carriages in front.

In regard to the change of gait, these movements are executed according to the principles of No. 493, in order that the right carriages may move out of the line and return to it again at the completion of the movement.

To close intervals.

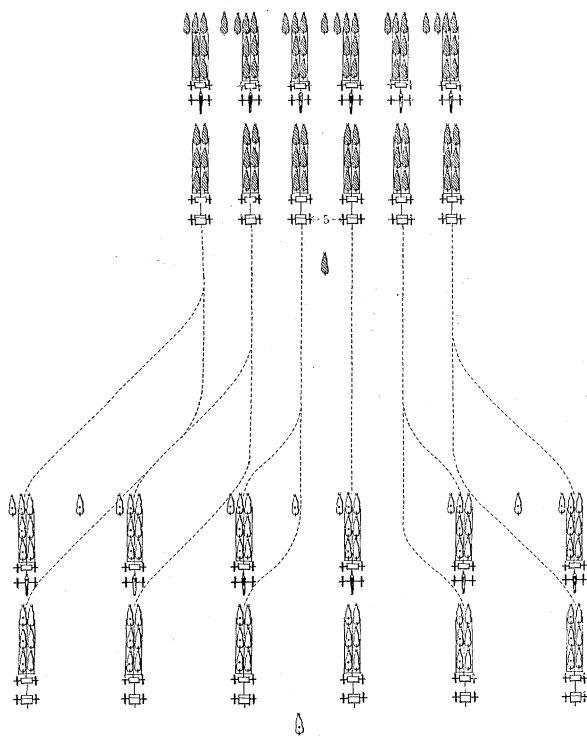

To resume intervals.

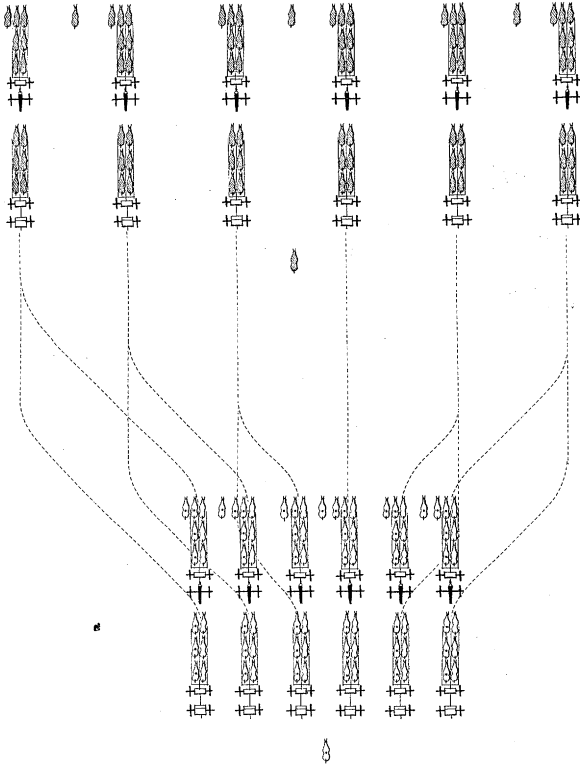

TO RESUME INTERVALS.

527. When the battery is marching in line with diminished intervals, to cause the regular intervals to be resumed, the captain commands:

1. *On right (or left) piece of ——— section—full intervals.*
2. MARCH.

(PLATE 51.) The chief of the section designated repeats the command: *On right (or left) piece—full interval*; and the other chiefs of sections command: *From the right (or left)—full intervals.*

At the command MARCH, repeated by the chiefs of sections, the carriage of direction in each rank continues to march to the front, and the others oblique from it at an increased gait to regain their intervals. Each carriage regulates its march by the one adjoining towards the carriage of direction, and, when the interval is regained, moves forward on the alignment and resumes its gait.

As soon as the movement is completed, the command for the guide is renewed by the captain, and repeated by the chiefs of sections.

When the intervals are to be resumed from one of the flanks, the captain commands:

1. *On right (or left) piece—full intervals.*
2. MARCH.

PASSAGE OF OBSTACLES.

528. When the battery is marching in line, to pass an obstacle which presents itself in front of one of the sections, the captain commands:

1. ——— *Section.*
2. OBSTACLE.

At the command OBSTACLE, the chief of the section designated observes the obstacle, and gives the necessary commands for closing on one of the adjoining sections, removing from it, breaking his section, or halting it and forming in column in rear of one

of the adjoining sections. The section generally resumes the regular march by means the inverse of those used for passing the obstacle. It resumes its place at an increased gait, and by the commands, *Section into line*—MARCH, from its chief.

The passage of defiles is nothing more than the passage of obstacles, which requires the line to be broken into column of sections, by one of the manœuvres prescribed for passing from the order in line to the order in column. When it becomes necessary to break the sections, they should be formed again in succession by their chiefs as soon as the ground will permit.

ARTICLE FIFTH.

FORMATIONS IN BATTERY.

IN LINE, WITH PIECES IN FRONT, TO FORM IN BATTERY TO THE FRONT.

529. WHEN the battery is in line at a halt, with the pieces in front, to form in battery to the front, the captain commands :

1. IN BATTERY.
2. *Guide left.*
3. MARCH.

(PLATE 52.) These commands are repeated by the chiefs of sections, and executed as prescribed in No. 465.

The chiefs of pieces and of sections take their posts *in battery* as soon as that formation is completed. *This rule is general.*

After the formation, the captain rectifies the alignment if necessary. The piece originally designated as such, continues to be the guide until the movement is completed, and the alignment is made upon it.

When the battery is marching in line with the pieces in front, it is formed in battery to the front according to the same principles, and by the commands :

1. IN BATTERY.
2. MARCH.

These commands are repeated by the chiefs of sections, and executed as prescribed in No. 465.

TO FORM IN BATTERY TO THE FRONT, BY THROWING THE
CAISSONS TO THE REAR.

530. When the battery is in line at a halt, with the pieces or

caissons in front, to form in battery to the front by throwing the caissons to the rear, the captain commands:

ACTION FRONT.

This command is repeated by the chiefs of sections, and executed as prescribed in No. 466.

In **horse artillery**, when the detachments conduct their horses to the rear, the cannoneers are dismounted without command from the captain. When he wishes the horses to be led to their positions by the horse holders, the captain commands *Cannoneers*, DISMOUNT: immediately after, ACTION FRONT, and the chiefs of sections repeat the commands.

The battery is generally in line at a halt when this mode of coming into action is resorted to. It may also be used in successive formations by giving the command ACTION FRONT, when a part of the battery has been halted on the line. But with bad ground or heavy pieces this mode of coming into action should not be used.

IN LINE, WITH CAISSONS IN FRONT, TO FORM IN BATTERY
TO THE FRONT.

531. When the battery is in line at a halt, with the caissons in front, to form in battery to the front, the captain commands:

1. *Pieces, pass your caissons*—MARCH.
2. IN BATTERY—*Guide left (or right.)*
3. MARCH.

(PLATE 52.) These commands are repeated by the chiefs of sections, the pieces pass their caissons, as prescribed in No. 520, and at the command IN BATTERY, given as soon as the pieces have passed their caissons, the formation is executed as prescribed in No. 529.

In **horse artillery**, the command IN BATTERY is given when the detachments have passed the caissons.

When the battery is marching in line, with the caissons in front, it is formed in battery to the front according to the same principles, and by the commands, *Pieces, pass your caissons*,

In line, with caissons in front to form in battery to the front.

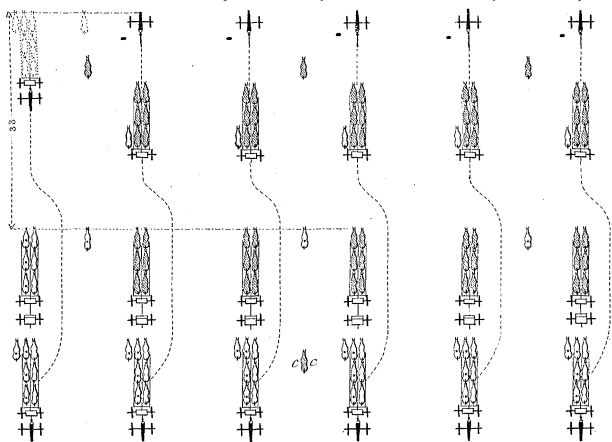

In line, with pieces in front, to form in battery to the front.

Mounted Battery.

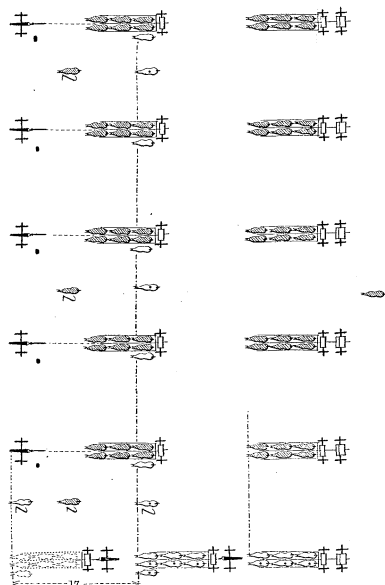

(or *Pieces, pass your caissons—trot*)—MARCH—IN BATTERY—
Guide left—MARCH.

IN LINE, WITH PIECES IN FRONT, TO FORM IN BATTERY TO
 THE REAR.

532. When the battery is in line at a halt, with the pieces in front, to form in battery to the rear, the captain commands :

1. *Fire to the rear.*
2. *Caissons, pass your pieces—trot*—MARCH.
3. IN BATTERY.

(PLATE 53.) The commands are repeated by the chiefs of sections. At the second, the caissons oblique to the right, pass their pieces at a brisk trot, advance 17 yards beyond them, execute a reverse together, and take their places in battery. At the third, which is given as soon as the caissons have passed, the cannoneers unlimber and prepare for firing.

When the cannoneers are mounted on the ammunition chests, the caissons halt to allow the cannoneers to dismount, before executing the reverse. As soon as the caissons halt, the cannoneers dismount and run to their posts. When the battery is at a halt, as in the present case, it is considered better to dismount the cannoneers before commencing the movement. The chief of the line of caissons precedes the movement of his carriages, and places himself on the line to be occupied by their leaders when the reverse is commenced. He takes his place in battery as soon as the reverse is completed and the carriages are on the line.

In horse artillery, at the command IN BATTERY, the detachments incline to the right, pass their pieces at a brisk trot, and take their places in battery by a left reverse. The cannoneers then dismount, run to their posts, unlimber, and prepare for firing.

When the battery is marching in line, with the pieces in front, the formation in battery to the rear is executed according to the same principles and by the same commands. At the command IN BATTERY, which is given as soon as the caissons have passed

their pieces, the latter halt, the detachments in horse artillery pass them, and the movement is completed as already described.

IN LINE, WITH CAISSONS IN FRONT, TO FORM IN BATTERY TO THE REAR.

533. When the battery is in line at a halt, with the caissons in front, to form in battery to the rear, the captain commands:

1. *Fire to the rear.*
2. IN BATTERY.

(PLATE 53.) At the command IN BATTERY, which is repeated by the chiefs of sections, the cannoneers unlimber and prepare for firing.

The chiefs of pieces and sections take their places in battery.

The caissons move at a brisk trot and take their places in battery, under the superintendence of their chief.

In horse artillery, at the command IN BATTERY, the detachments pass their pieces at a trot, move to their places in battery, dismount, and run to their posts, as prescribed in No. 532.

When the battery is marching in line, with the caissons in front, the formation in battery to the rear is executed according to the same principles and by the same commands.

IN BATTERY, TO FORM IN LINE TO THE FRONT.

534. Being in battery, to form in line to the front with the caissons in rear, the captain commands:

LIMBER TO THE FRONT.

This command is repeated by the chiefs of sections, and the pieces are limbered as described in No. 115; the caissons closing at the same time to the proper distance without further command.

When the captain wishes to place the caissons in front, he commands: LIMBER TO THE FRONT; and while the pieces are limbering, *Caissons, pass your pieces—trot—MARCH.* The caissons pass and halt in front of their pieces; or, if the captain wishes the battery to advance, he commands: FORWARD—*Guide right (or left,)* as the caissons are completing the passage.

*In line, with pieces in front, to form
in battery to the rear.*

*In line, with caissons in front, to form
in battery to the rear.*

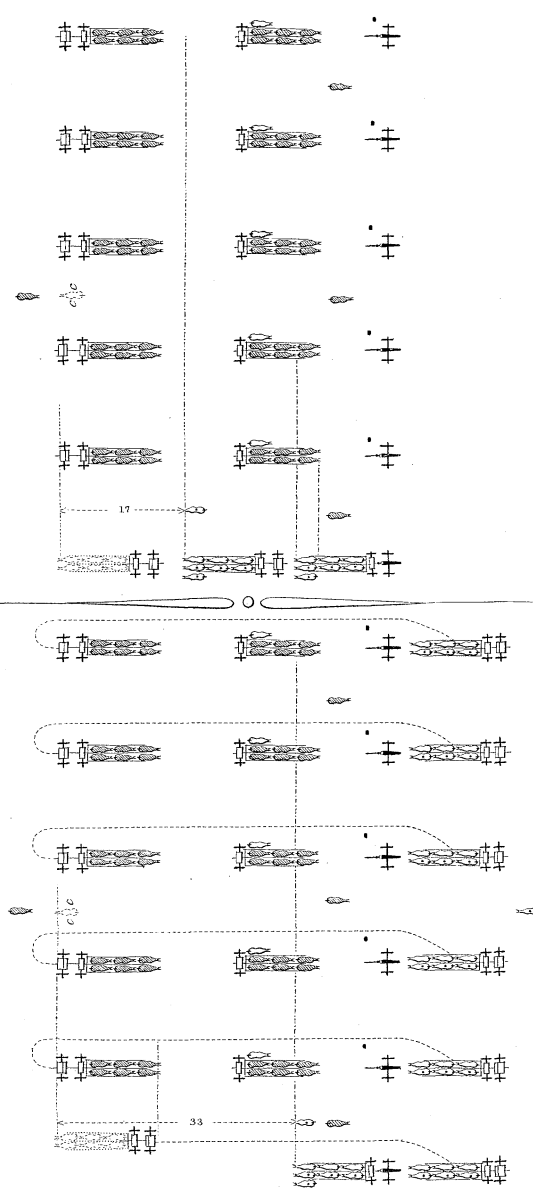

*In battery to form forward into line, with pieces
in front, by lumbering to the rear.*

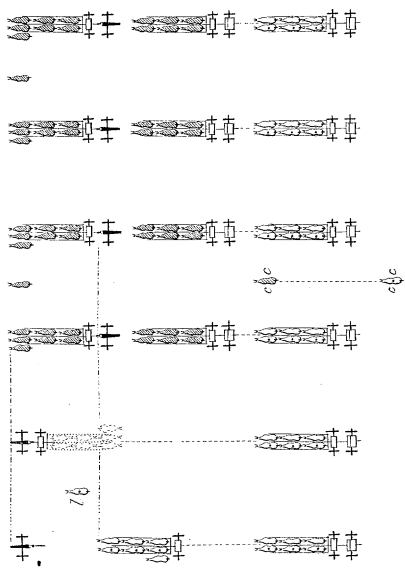

*In battery to form forward into line, with caissons
in front, by lumbering to the rear.*

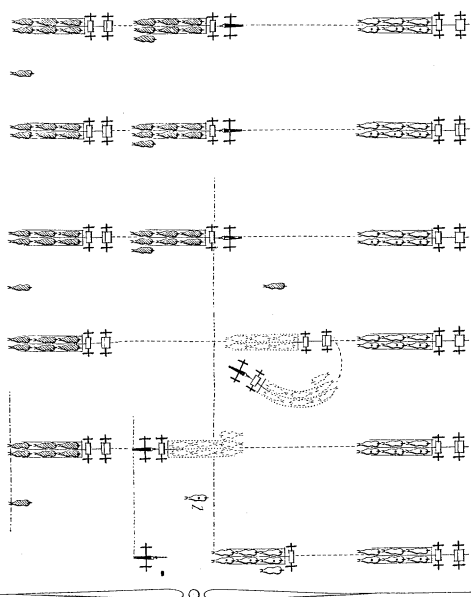

The commands are repeated by the chiefs of sections.

In **horse artillery**, when the pieces are limbered to the front, the horse holders advance within 2 yards of their pieces; and there the cannoneers mount.

When the pieces cannot be wheeled about by hand, the captain commands: **LIMBER TO THE REAR**; and when this is executed, if he wishes to retain the pieces in front, he commands:

1. *Pieces, left about—caissons, forward.*
2. **MARCH.**
3. *Battery—HALT.*

(PLATE 54.) The command **LIMBER TO THE REAR** is repeated by the chiefs of sections. The first and second commands are also repeated by the chiefs of sections, and the pieces execute the about; the caissons closing at the same time to 2 yards. The third command is given as soon as the about is completed, and the word **HALT** being repeated by the chiefs of sections, the pieces halt and place themselves squarely on the line.

The captain rectifies the alignment, if necessary, and commands: **FRONT**.

When the battery is to advance immediately, the captain commands: **FORWARD—Guide right (or left,)** instead of *Battery—HALT*; and the caissons close on the march.

(PLATE 54.) When the captain wishes to place the caissons in front, he may cause the pieces to be limbered to the rear as before, and commands:

1. *Caissons, pass your pieces—trot—pieces, left about.*
2. **MARCH.**
3. *Battery—HALT, or FORWARD—Guide right (or left.)*

These commands are repeated and executed as prescribed in No. 470.

IN BATTERY, TO FORM IN LINE TO THE REAR.

535. When in battery, to form in line to the rear, the captain causes the pieces to be limbered to the rear; and then, if he wishes to place the caissons in front, commands:

1. *Caissons, left about—pieces, forward.*
2. MARCH.
3. *Battery—HALT, or FORWARD—Guide right (or left.)*

(PLATE 55.) The first two commands are repeated by the chiefs of sections; the caissons execute the about; and the pieces close to their proper distance. The third command, which is given at the moment the about is finished, is repeated and executed as prescribed.

The captain rectifies the alignment if necessary, and commands: FRONT.

If the formation in line to the rear is to be executed by placing the pieces in front, the captain, after causing the pieces to be limbered to the rear, commands:

1. *Pieces, pass your caissons—caissons, left about.*
2. MARCH.
3. *Battery—HALT, or FORWARD—Guide right (or left.)*

(PLATE 55.) The first two commands are repeated by the chiefs of sections; and the pieces pass their caissons as the caissons execute the about, No. 472. The third command is repeated and executed according to the principles prescribed in No. 534.

The captain rectifies the alignment if necessary, and commands: FRONT.

In forming line to the rear the caissons may be placed at once either in front or in rear of their pieces. To effect this the captain commands: LIMBER TO THE REAR, and immediately adds, to place them in front:

1. *Caissons, in front of your pieces, (or Caissons, in front of your pieces—trot.)* 2. MARCH.

If he wishes to place them in rear, the commands are:

1. *Caissons, in rear of your pieces, (or Caissons, in rear of your pieces—trot.)* 2. MARCH.

The commands in both cases, are repeated by the chiefs of sections, and executed as prescribed in No. 472.

*In battery, to form in line to the rear,
with pieces in front.*

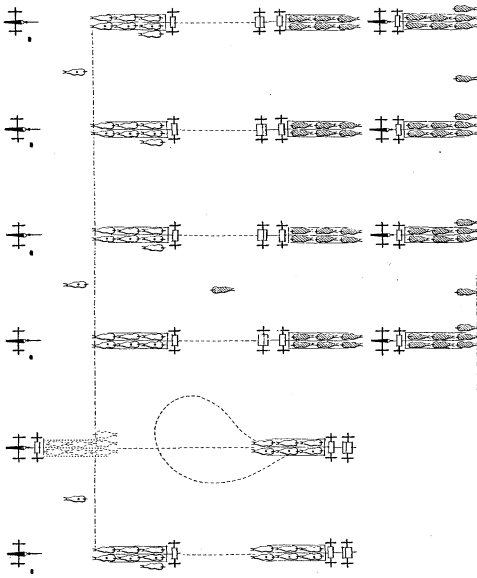

*In battery, to form in line to the rear,
with caissons in front.*

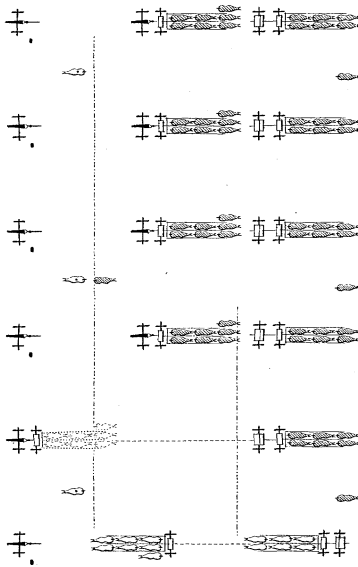

*In column, with pieces in front, to form
in battery to the front.*

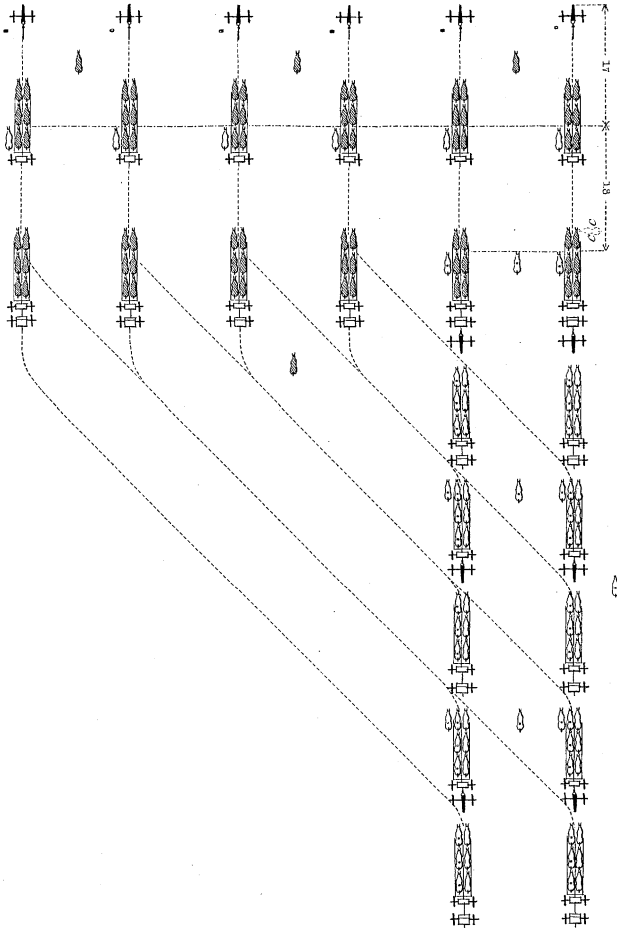

IN COLUMN WITH PIECES IN FRONT, TO FORM IN BATTERY TO THE FRONT.

536. When the battery is in column at a halt, with the pieces in front, to form in battery to the front by gaining ground to the left, the captain commands :

1. *Forward into battery—left oblique.*
2. MARCH.
3. *Guide right.*

(PLATE 56.) At the first command, the chief of the leading section commands: *Section—forward*; and those of the other sections: *Section—left oblique*. The chief of the line of caissons moves quickly to the right of the leading section, to cause the caissons to halt at the proper time and to superintend their alignment. At the command MARCH, repeated by the chiefs of sections, the movement is executed as prescribed in No. 500, for forming line to the front. But as each section arrives on the line, instead of halting, its chief forms it in battery to the front by the commands: IN BATTERY—MARCH, which are executed as prescribed in No. 465.

The formation in battery to the front, by gaining ground to the right, is executed according to the same principles, and by inverse means. The commands are :

Forward into battery—right oblique—MARCH—Guide left.

When the battery is marching in column, it is formed in battery to the front by applying the principles of Nos. 500 and 465.

IN COLUMN WITH CAISSONS IN FRONT, TO FORM IN BATTERY TO THE FRONT.

537. When the battery is in column at a halt, with the caissons in front, to form in battery to the front by gaining ground to the left, the captain commands :

1. *Forward into battery—left oblique.*
2. MARCH.
3. *Guide right.*

(PLATE 57.) At the first command, the chief of the leading section commands: *Section—forward*; and those of the other sections: *Section—left oblique*. The chief of the line of caissons moves quickly to the right of the leading section, to halt the caissons at the proper time and to superintend their alignment. At the command MARCH, repeated by the chiefs of sections, the movement is executed as prescribed in No. 500, for forming line to the front. But as each section arrives on the line, instead of halting, its chief forms it in battery to the front by the commands, *Pieces, pass your caissons—MARCH—IN BATTERY—MARCH*, which will be executed as prescribed in No. 467.

The formation in battery to the front, by gaining ground to the right, is executed according to the same principles, and by inverse means.

When the battery is marching in column, it is formed in battery to the front by applying the principles of Nos. 500 and 467.

IN COLUMN WITH PIECES IN FRONT, TO FORM IN BATTERY TO THE REAR.

538. When the battery is in column at a halt, with the pieces in front, to form in battery to the rear, by gaining ground to the left, the captain commands:

1. *Into battery faced to the rear—left oblique.*
2. MARCH.
3. *Guide right.*

(PLATE 58.) At the first command, the chief of the leading section commands: *Section—forward*; and those of the other sections: *Section—left oblique*. The chief of the line of caissons goes to the right of the leading section, to direct the reverse of the caissons, as prescribed in No. 532, and to superintend their alignment. At the command MARCH, repeated by the chiefs of sections, the movement is executed as prescribed in No. 500, for forming line to the front. But as each section arrives on the line, instead of halting, its chief forms it in battery to the rear by the commands: *Fire to the rear—Caissons, pass your pieces—trot*

*In column, with caissons in front, to form
in battery to the front.*

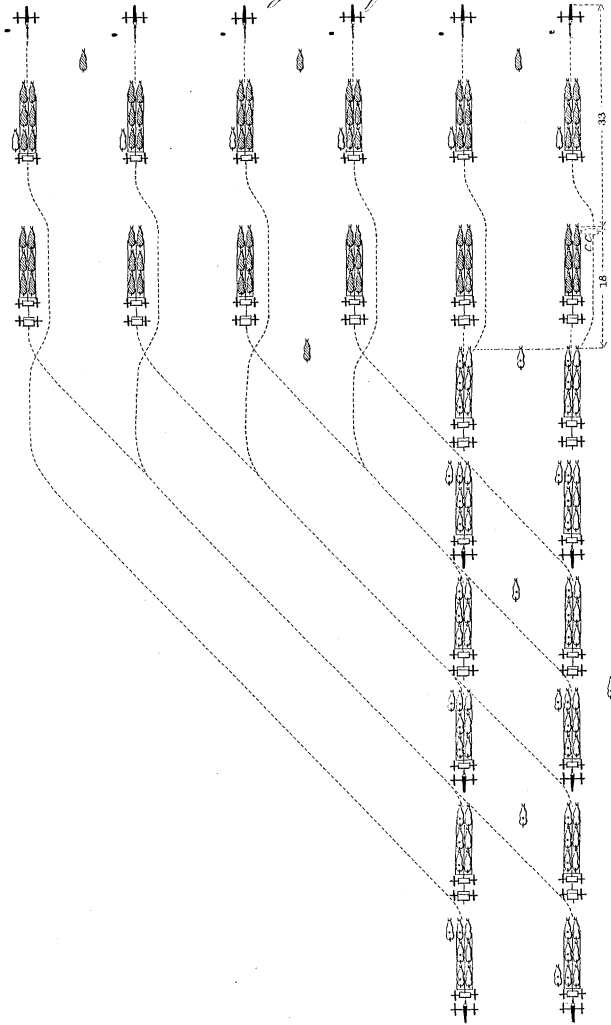

*In column, with pieces in front, to form
in battery to the rear.*

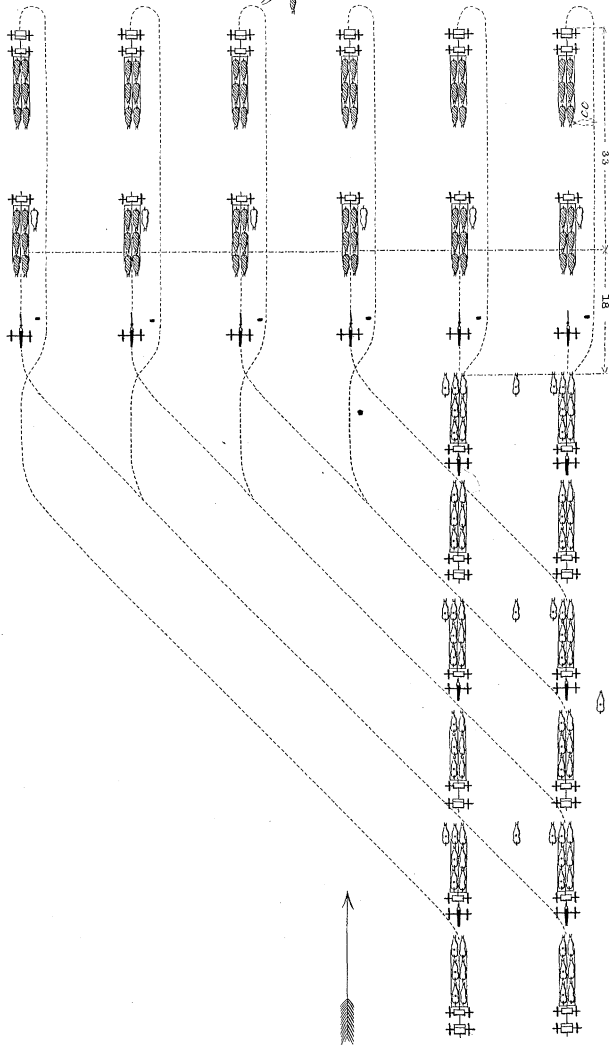

*In column, with caissons in front, to form
in battery to the rear.*

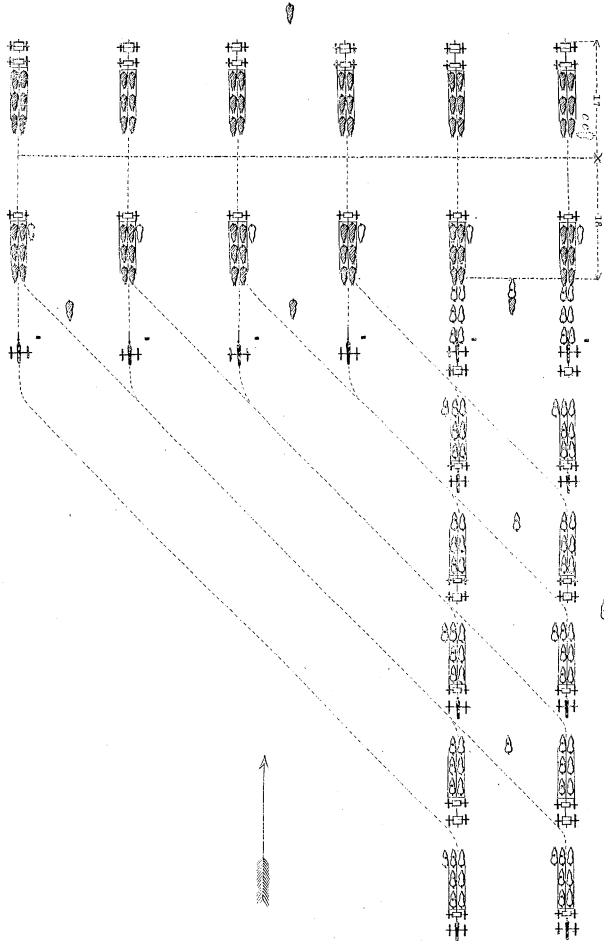

—MARCH—IN BATTERY, which are executed as prescribed in No. 468.

The formation in battery to the rear, by gaining ground to the right, is executed according to the same principles, and by inverse means.

When the battery is marching in column, it is formed into battery to the rear by applying the principles of Nos. 500 and 468.

IN COLUMN WITH CAISSONS IN FRONT, TO FORM IN BATTERY
TO THE REAR.

539. The battery being in column at a halt, with the caissons in front, to form in battery to the rear, by gaining ground to the left, the captain commands :

1. *Into battery faced to the rear—left oblique.*
2. MARCH.
3. *Guide right.*

(PLATE 59.) At the first command, the chief of the leading section commands: *Section—forward*; and those of the other sections: *Section—left oblique*. The chief of the line of caissons goes to the right of the leading section, to direct the about of the caissons, and to superintend their alignment. At the command MARCH, repeated by the chiefs of sections, the movement is executed as prescribed in No. 500, for forming line to the front. But as each section arrives on the line, instead of halting, its chief forms it into battery to the rear by the commands, *Fire to the rear*—IN BATTERY, which are executed as prescribed in No. 469.

The formation in battery to the rear, by gaining ground to the right, is executed according to the same principles, and by inverse means.

When the battery is marching in column, it is formed into battery to the rear by applying the principles of Nos. 500 and 469.

IN COLUMN WITH PIECES IN FRONT, TO FORM IN BATTERY
TO THE RIGHT OR LEFT.

540. When the battery is in column, in march, or at a halt,
21

with the pieces in front, if the captain wishes to form it in battery to the left, by gaining ground to the right, he commands :

1. *Fire to the left—by section, right wheel.*
2. MARCH.
3. *Caissons, pass your pieces—trot.*
4. MARCH.
5. IN BATTERY.

(PLATE 60.) At the first command, the chiefs of sections command: *Section—right wheel*; and at the second, which they repeat, all the sections wheel to the right, as prescribed in No. 453. The caissons follow their pieces at the proper distance.

At the commands, *Caissons, pass your pieces—trot—MARCH*, which are given before the completion of the wheel, and repeated by the chiefs of sections, all the caissons pass their pieces at a trot.

At the command IN BATTERY, which is given and repeated in like manner as soon as the caissons have passed, and the pieces are square on the new line, all the sections form at once into battery to the rear, as prescribed in No. 532.

When the captain wishes to form in battery to the left, by gaining ground to the left, he commands :

1. *Fire to the left—by section, left wheel.*
2. MARCH.
3. IN BATTERY.
4. MARCH.

(PLATE 61.) At the first command, the chiefs of sections command: *Section, left wheel*; and at the second, which they repeat, all the sections wheel at once to the left, as prescribed in No. 453.

At the command IN BATTERY, which is given and repeated as soon as the caissons have completed the wheel, all the sections form at once into battery to the front, as prescribed in No. 529.

The two formations in battery to the right, by gaining ground to the left or right, are executed according to the same principles, and by inverse means. The commands are: *Fire to the right—by section, left wheel—MARCH—Caissons, pass your pieces—*

In column, with pieces in front, to form in battery to the left, gaining ground to the right.

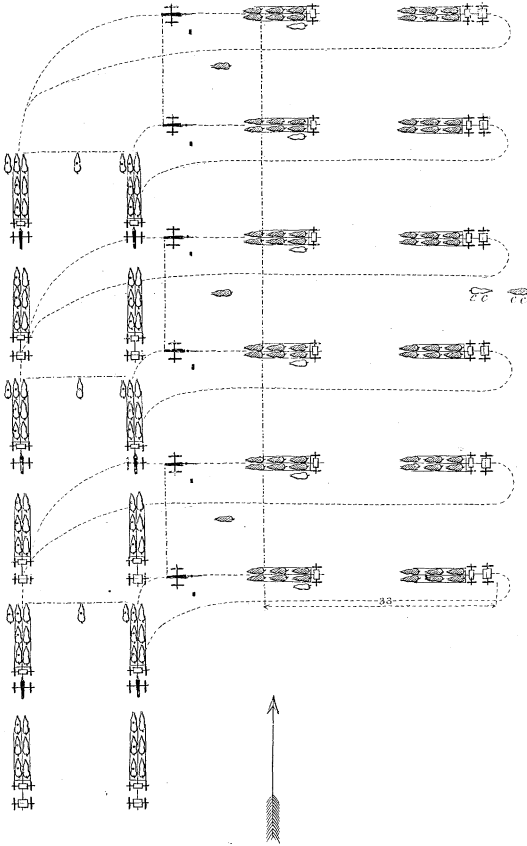

In column, with pieces in front, to form in battery to the left, gaining ground to the left.

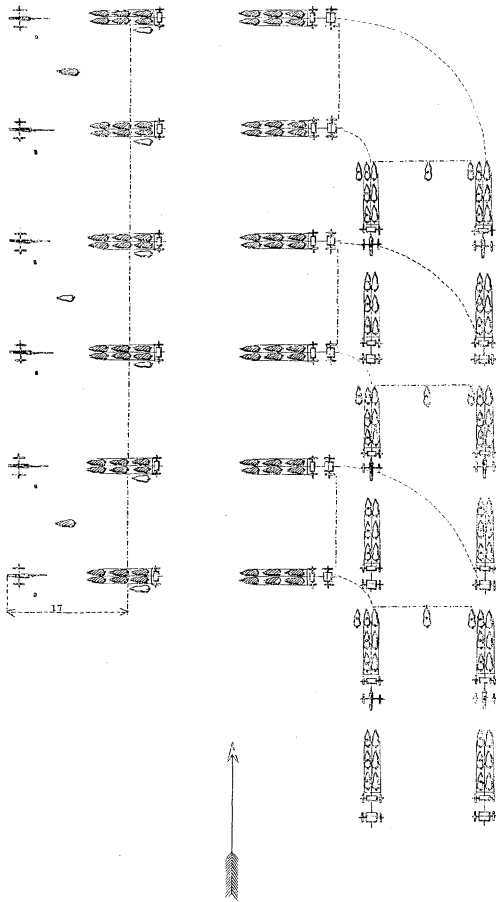

*In column, with pieces in front, to form in battery
to the right gaining ground to the left.*

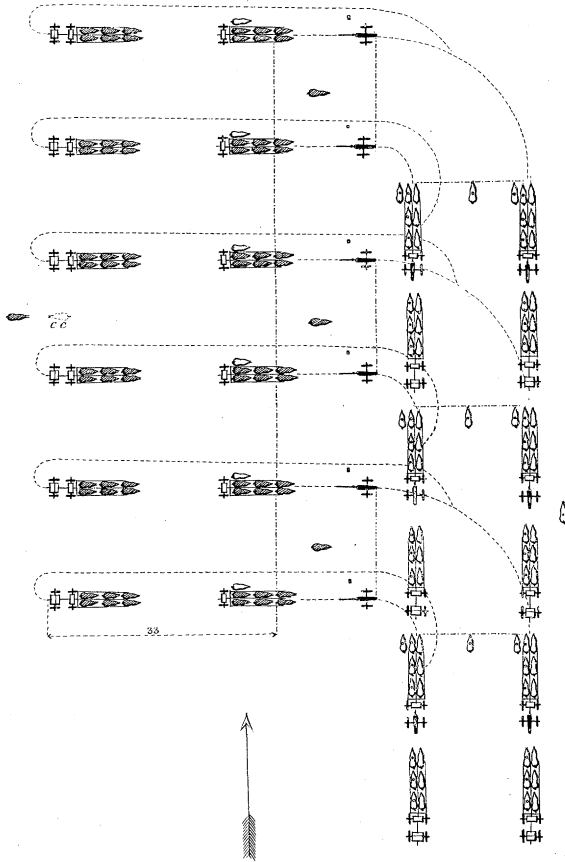

In column, with caissons in front, to form in battery to the left, gaining ground to the right.

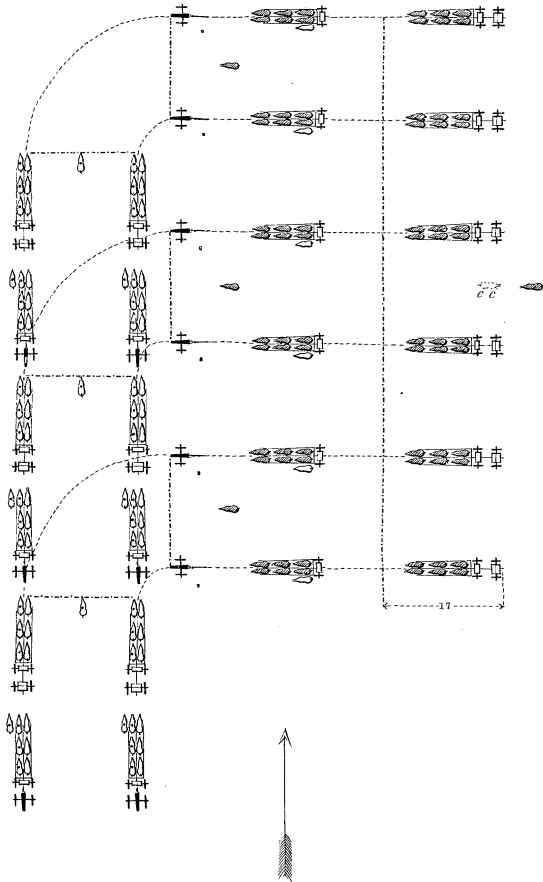

In column, with caissons in front, to form in battery to the left, gaining ground to the left.

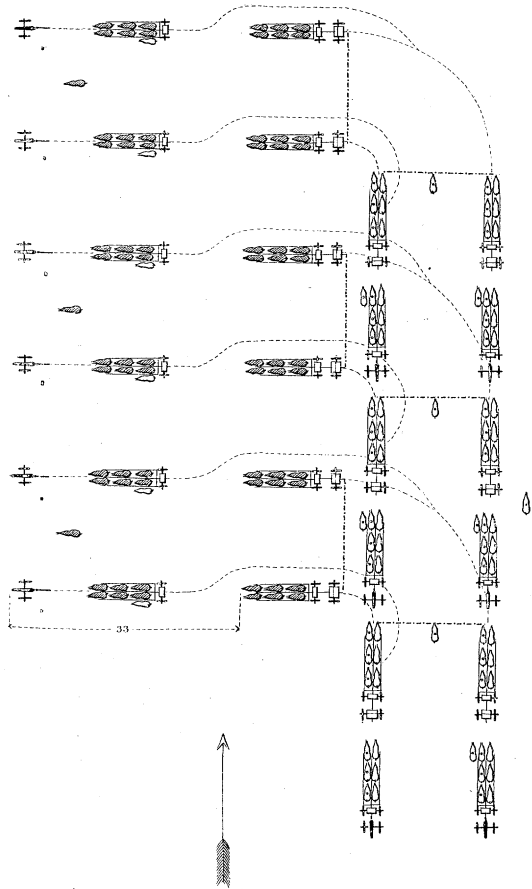

trot—MARCH—IN BATTERY; (PLATE 62.) Or, *Fire to the right*
—*by section, right wheel*—MARCH—IN BATTERY—MARCH.

IN COLUMN WITH CAISSONS IN FRONT, TO FORM IN BATTERY
TO THE RIGHT OR LEFT.

541. When the battery is in column, in march, or at a halt, with the caissons in front, to form it in battery to the left, by gaining ground to the right, the captain commands:

1. *Fire to the left—by section, right wheel.*
2. MARCH.
3. IN BATTERY.

(PLATE 63.) At the first command, the chiefs of sections command: *Section—right wheel*; and at the second, which they repeat, the sections wheel at once to the right, and move to the front at the commands, FORWARD—*Guide right*, from their chiefs.

At the command IN BATTERY, which is given and repeated as soon as the pieces are square on the new line, all the sections form at once into battery to the rear, as prescribed in No. 533.

To form in battery to the left, by gaining ground to the left, the captain commands:

1. *Fire to the left—by section, left wheel.*
2. MARCH.
3. *Pieces, pass your caissons.*
4. MARCH.
5. IN BATTERY.
6. MARCH.

(PLATE 64.) At the first command, the chiefs of sections command: *Section—left wheel*; and at the second, which they repeat, the sections wheel at once to the left. The third and fourth commands are given and repeated just before the completion of the wheel; and the fifth is given when the pieces have passed their caissons, and the latter are square upon the new line. The sections are then formed in battery to the front, as prescribed in No. 529.

The formations in battery to the right, by gaining ground to

the right or left, are executed according to the same principles, and by inverse means. (PLATE 65.)

IN COLUMN WITH PIECES IN FRONT, TO FORM IN BATTERY
ON THE RIGHT OR LEFT.

542. When the battery is marching in column with the pieces in front, to form in battery on the right, the captain commands:

1. *On the right into battery.*
2. MARCH.
3. *Guide right.*

At the first command, the chief of the leading section commands: *Section—right wheel*; and the chief of the line of caissons goes to that section, (No. 536.) At the command MARCH, repeated by the chief of the leading section, that section wheels to the right, and its chief conducts it to the line by the commands, FORWARD—*Guide right*, as prescribed in No. 503. And then, without halting, it is formed into battery to the front, as prescribed in No. 465, by the commands, IN BATTERY—MARCH— from its chief.

The other sections continue to advance; and as each arrives opposite its place in battery, after passing the one preceding it in the formation, it is formed into battery by its chief, by the commands, *Section—right wheel—MARCH—FORWARD—Guide right—IN BATTERY—MARCH*; the command IN BATTERY being given as the caissons arrive in line with those already established.

The formation in battery on the left is executed according to the same principles, and by inverse means.

When the battery is in column at a halt, it is formed in battery on the right or left according to the same principles. In this case, the chiefs of the two rear sections command: *Section—forward*, immediately after the first command of the captain, and then repeat the commands MARCH—*Guide right (or left).*

Two columns, with caissons in front, to form in battery to the right, gaining ground to the right.

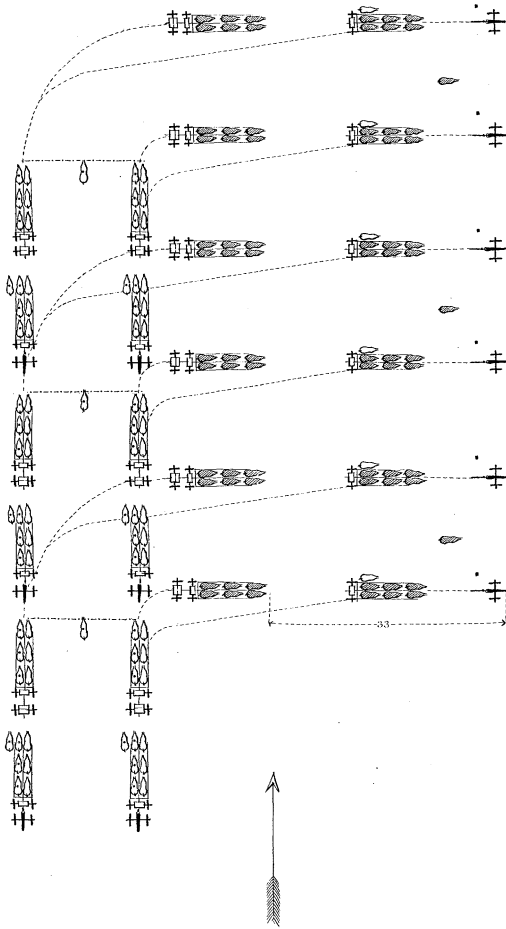

IN COLUMN WITH CAISSONS IN FRONT, TO FORM IN BATTERY
ON THE RIGHT OR LEFT.

543. When the battery is marching in column, with the caissons in front, to form in battery on the right, the captain commands:

1. *On the right into battery.*
2. MARCH.
3. *Guide right.*

At the first command, the chief of the leading section commands: *Section—right wheel*; and the chief of the line of caissons goes to that section, (No. 536.) At the command MARCH, repeated by the chief of the leading section, that section wheels to the right, and is conducted to the line, by the commands, FORWARD—*Guide right*, from its chief; as soon as it reaches the line, the section is formed in battery to the front by the commands, *Pieces, pass your caissons*—MARCH—IN BATTERY—MARCH, from its chief, (No. 467.)

The other sections continue to advance, and as each arrives opposite its place in battery, after having passed the one preceding it in the formation, it is wheeled to the right, and formed into battery by its chief, in the same manner as the leading section.

The formation in battery on the left is executed according to the same principles, and by inverse means.

When the battery is in column at a halt, it is formed in battery on the right or left according to the same principles: the chiefs of the two rear sections giving the additional commands prescribed in No. 542.

TO DEPLOY THE DOUBLE COLUMN INTO BATTERY TO THE
FRONT OR REAR.

544. The battery being in double column at a halt, to deploy it into battery to the front, the captain commands:

1. *Forward into battery.*
2. MARCH.

At the first command, the chief of the centre section commands: *Section—forward*; that of the right: *Section into line—right oblique*; that of the left: *Section into line—left oblique*; and the chief of the line of caissons goes to the leading section, (No. 536.) At the command MARCH, repeated by the chiefs of sections, the centre section advances 5 yards, and, without halting, is formed into battery to the front, as prescribed in Nos. 465 or 467, according to the kind of carriage in front.

The pieces of the flank sections are brought upon the line by obliquing, and placed successively in battery without command; regulating by the centre section.

When the battery is marching in double column, it is deployed into battery to the front in the same manner, except that the chief of the centre section does not command, *Section—forward—MARCH*.

When the battery is in double column, marching, or at a halt, it is deployed into battery to the rear according to the principles prescribed in this number and in Nos. 538 or 539, according to the kind of carriage in front. The commands are:

1. *Into battery faced to the rear.*
2. MARCH.

When the battery consists of four or eight pieces, the double column is deployed into battery to the front or rear, by the same commands from the captain as when it consists of six. The sections are formed into battery as prescribed for the flank sections in this number. The leading chief of section, besides superintending the formation of his own, gives the commands required for the centre section, and the leading pieces conform to the movements of that section.

TO DEPLOY THE DOUBLE COLUMN INTO BATTERY TO THE RIGHT OR LEFT.

545. When the battery is in double column, marching, or at a halt, to form it in battery to the right, the captain commands:

1. *To and on the right into battery.*
2. MARCH.

In battery, to march to the left and form again, in battery.

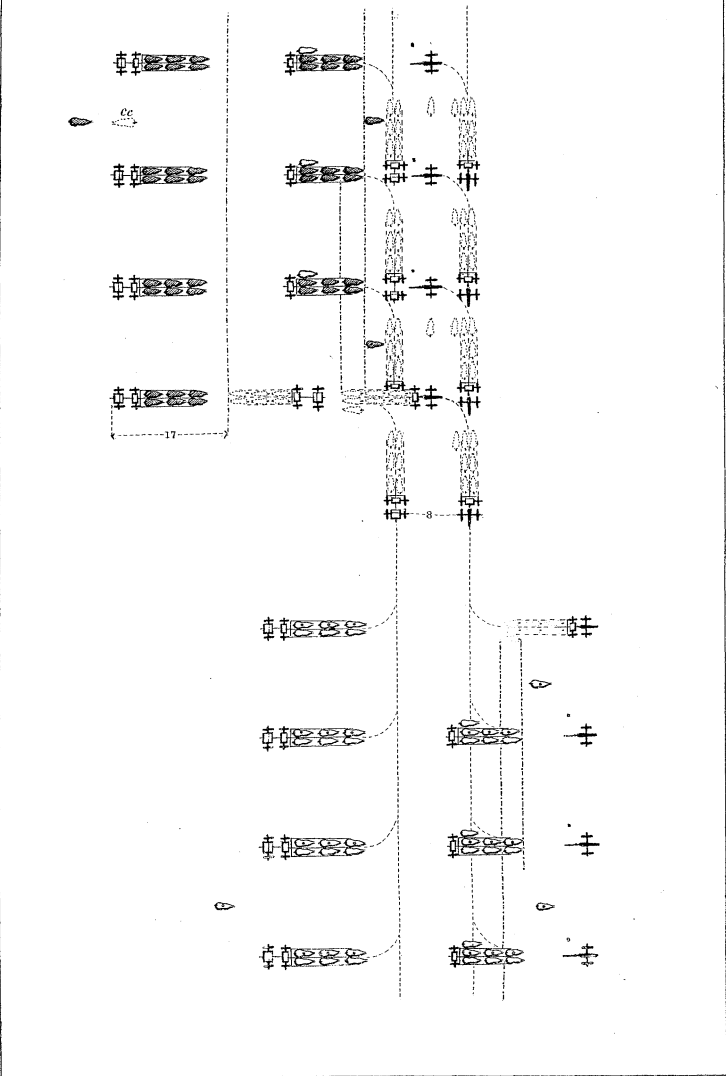

The centre section is formed in battery on the right, as prescribed for the leading section in Nos. 542 or 543, according to the kind of carriage in front.

The other pieces are brought into line as prescribed in No. 514, and, without halting, are formed successively in battery to the front without commands; regulating by the centre section.

The deployment into battery to the left is executed according to the same principles, and by inverse means.

When the battery consists of four or eight pieces, the column is deployed into battery to the right or left by the same commands from the captain as when it consists of six. In this case, the leading pieces are wheeled to the right or left as a section, and conducted to the line by the leading chief of section, as prescribed in No. 514. And then, without halting, they are formed into battery to the front by the same chief. The other pieces move forward, wheel in succession as they arrive opposite their places, and form in battery on the alignment of those already established.

TO PASS FROM THE ORDER IN BATTERY TO THE ORDER
IN COLUMN.

546. Being in battery, to form column, the captain first causes the line to be formed as prescribed in Nos. 534 or 535, and then forms column by one of the manœuvres for passing from the order in line to the order in column.

TO MARCH BY A FLANK.

547. Being in battery, to gain ground to the left, for the purpose of forming again in battery without an intermediate formation, the captain causes the pieces to be limbered to the rear, and commands:

1. *Pieces right—caissons left—wheel.*
2. MARCH.
3. FORWARD.
4. *Guide right.*

(PLATE 66.) These commands are repeated by the chiefs of sections, and executed as prescribed in No. 473.

The movement to gain ground to the left may be executed by limbering at once to the left; the caissons wheeling to the left while the pieces are limbering; and the captain afterwards commanding, *Forward—MARCH—Guide right.*

In horse artillery, the captain warns the horse holders to stand fast whilst the piece is limbered to the rear: they move to the left of their pieces when limbering to the left.

The movement to gain ground to the right is executed by either of the methods above described, applying the same principles, and by inverse means.

As soon as the battery has reached the position on the left, which it is intended to occupy, the captain commands:

1. *Battery by the left flank.*
2. MARCH.
3. *Fire to the rear.*
4. IN BATTERY.

The commands, *By the left flank—MARCH*, are repeated by the chiefs of sections, and executed as usual. The commands, *Fire to the rear—IN BATTERY*, are given and repeated as soon as the pieces have completed the wheel, and executed as prescribed in No. 533.

(PLATE 67.) In horse artillery, the detachments follow the movements of their caissons, and take their places in battery.

When the battery is to move to a flank and be formed into battery again on the same line, it may be executed by limbering to the front, marching to a flank, and then commanding, *Column—by the right (or left) flank—MARCH—Fire to the rear—IN BATTERY*; the caissons taking their proper places in battery by a left about.

The same thing may be executed by limbering to the right or left, gaining ground to the flank, halting, and commanding, *ACTION LEFT or ACTION RIGHT*; which will be executed as prescribed in No. 473.

In horse artillery, the detachments wheel to the right or left and take their places in battery.

In all cases when a battery is halted or marching in a flank

In battery, to march to the left, and form, again, in battery.

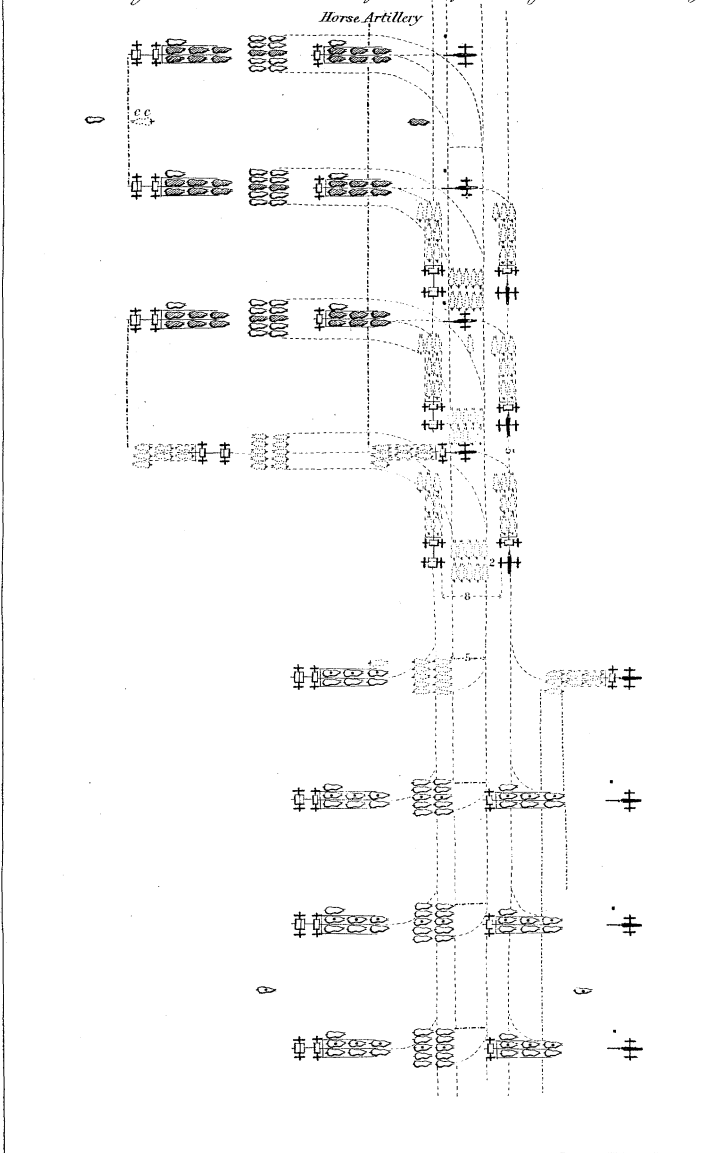

direction, it may be formed into battery to the right or left, by the command **ACTION RIGHT** or **ACTION LEFT**.

In **horse artillery**, this mode of coming into battery should not be resorted to, when the caissons are required to pass their pieces, unless the horses may be easily conducted to their places by the horse holders. In this case the captain commands: **DISMOUNT**, immediately after **ACTION RIGHT** or **ACTION LEFT**.

ARTICLE SIXTH.

FIRINGS.

548. WHEN everything is prepared for firing, the captain commands:

COMMENCE FIRING.

This command, given by itself or after LOAD, is repeated by the chiefs of sections, and the firing is immediately commenced.

The firing by battery, by half battery, by section, and by piece, will be governed by the principles laid down in No. 477, the captain giving the directions prescribed for the instructor.

To fire by battery, the captain commands:

1. *Fire by battery.*
2. *Battery—FIRE.*

The first command is repeated by the chiefs of sections; the second is not repeated.

To fire by half battery, the commands of the captain are:

1. *Fire by half battery.*
2. *Right (or left) half battery—FIRE.*

To fire by section:

1. *Fire by section.*
2. *Right (centre or left) section—FIRE.*

To fire by piece:

1. *Fire by piece.*
2. *Right section—right (or left) piece—FIRE.*

The chiefs of half batteries or sections repeat the first command, and immediately designate their respective commands as *Right* or *left* half battery—*Right* or *left* section. They do not repeat the second commands.

The firing is discontinued by the command or signal:

CEASE FIRING.

To fire advancing by half battery.

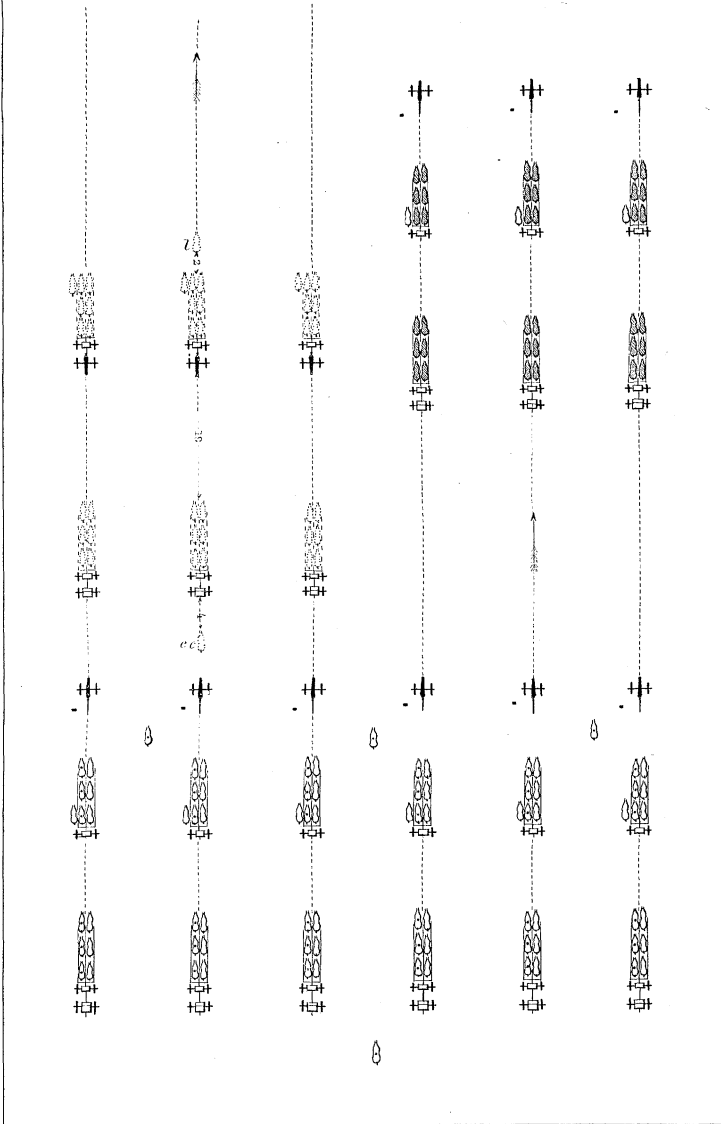

This command is repeated by the chiefs of sections and of pieces, and the loaded pieces discharged or the load drawn, except in the case when the battery is retiring with the prolonge.

549. To move and fire with the prolonge fixed, the captain gives the necessary directions, which are executed as prescribed in No. 476. It is but seldom that this mode of moving and firing is necessary, and it will only be resorted to when circumstances require it.

TO FIRE ADVANCING.

550. When the battery is firing, to advance by half batteries, the captain commands:

1. *Fire advancing—by half battery.*
2. *Right half battery—ADVANCE.*

(PLATE 68.) At the second command, the chief of the right half battery discontinues firing, causes his pieces to be limbered to the front, and commands: *Forward—MARCH—Guide left.* Or, he may cause them to be limbered to the rear, and, after executing the about, command: *FORWARD—Guide left.* The half battery advances and the caissons preserve their distance in battery.

As soon as the right half battery reaches the new position, previously indicated by the captain, its chief places it in battery by the commands, *HALT—ACTION FRONT; or IN BATTERY—MARCH;* the two last commands being given in quick succession. The caissons halt at these commands; and as soon as the pieces are unlimbered, the firing is renewed by command from the chief of half battery.

The fire of the left half battery is continued during the movement of the right; care being taken to direct the pieces, so that their fire shall not injure the half battery in advance.

As soon as the right half battery commences firing, the left moves forward with the guide to the right; and, after passing the right half battery as far as the latter has advanced, is formed into battery and the firing commenced. The movements of the left half battery are effected by commands and means corresponding to those of the right.

The right half battery again advances, as soon as the left commences firing; and the two continue to advance alternately until the captain causes the firing to cease. The battery is then aligned, or formed into line to the front or rear by the proper commands from the captain.

While advancing by half battery, the captain places himself habitually with the most advanced portion of the battery; and in six-gun batteries is accompanied by the chief of the centre section. The chief of the line of caissons remains habitually with the rear half battery.

In horse artillery, while advancing by half battery, the detachments preserve their distance in battery. When the pieces are limbered to the front, the horse holders advance, to enable the cannoneers to mount more readily; but as soon as the pieces advance, the detachments resume their distance in battery.

To fire advancing by half battery, commencing with the left, is executed according to the same principles, and by inverse means.

The movement may also be executed by section; the sections advancing in succession according to their positions in the battery.

TO FIRE IN RETREAT.

551. When the battery is firing, to retire by half batteries, the captain commands:

1. *Fire retiring by half battery.*
2. *Right half battery—RETIRE.*

(PLATE 69.) At the second command, the chief of the right half battery discontinues firing, limbers to the rear, and commands: *Caissons, left about—MARCH.* As soon as the about is completed, he commands: *FORWARD—Guide right;* and conducts the half battery to the ground previously indicated by the captain; the pieces preserving their distance in battery by marching 19 yards in rear of the caissons. As soon as the ground has been reached, the chief of half battery commands: *HALT—Fire to the rear—IN BATTERY,* and commences firing; taking care not to injure the other half battery. The limbers and caissons remain facing towards the rear, as long as the firing in retreat continues.

To fire retiring by half battery.

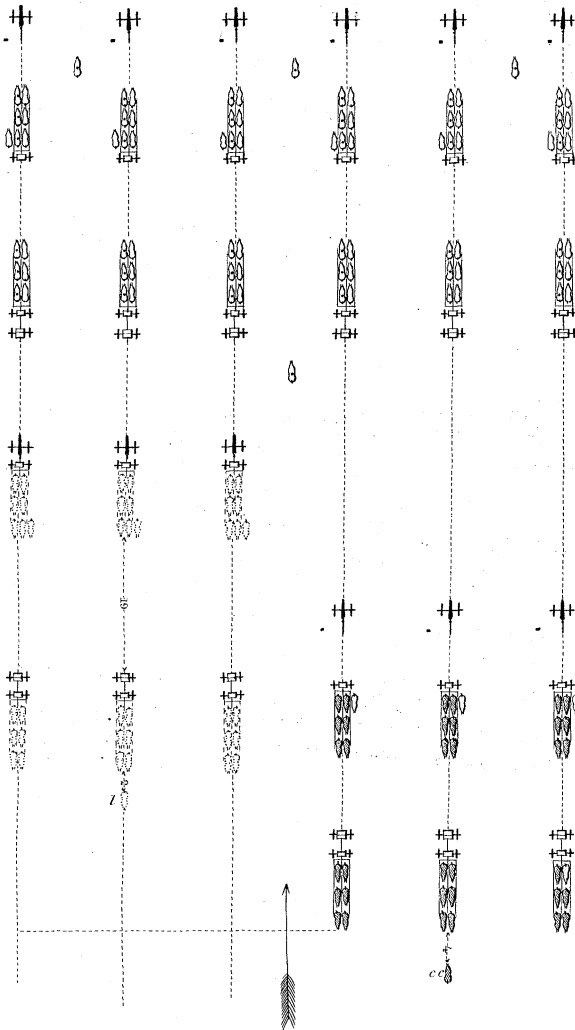

Echelon.

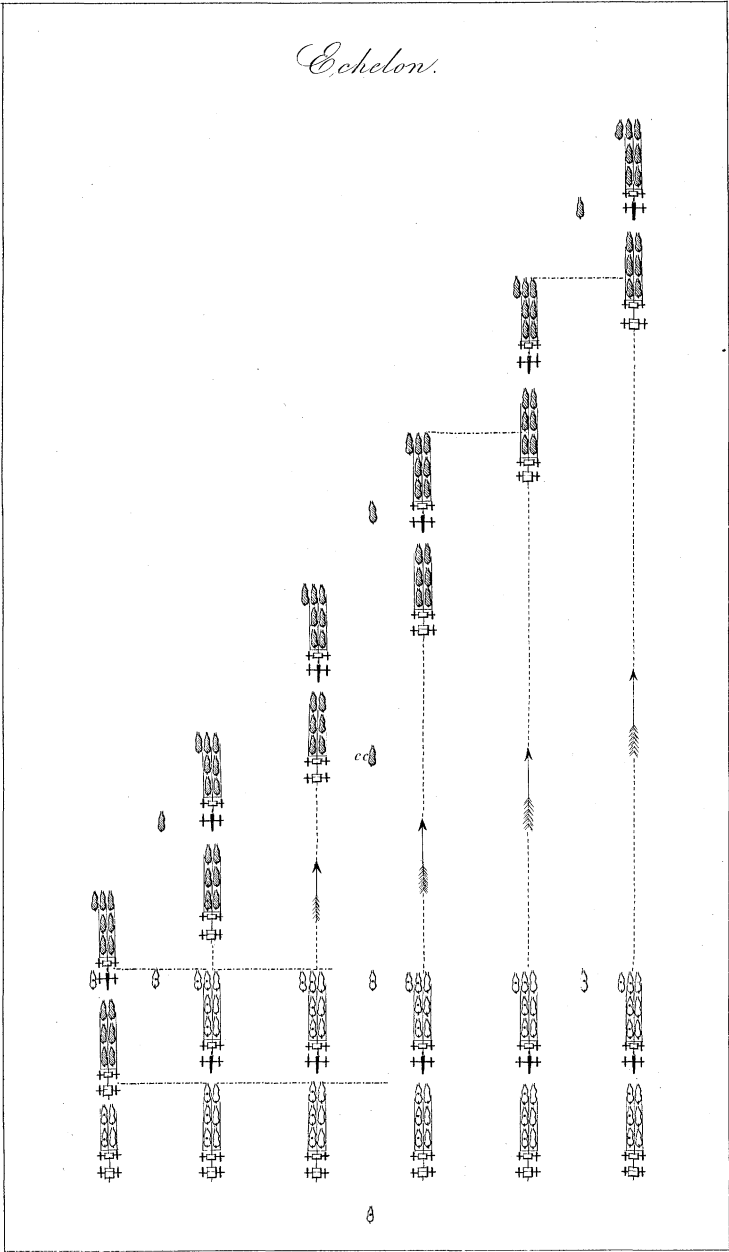

As soon as the right half battery commences firing, the left retires with the guide to the left; and, after passing the right half battery as far as the latter has retired, it is formed into battery, and the firing again commenced. The movements are executed in a manner corresponding to those of the other half battery.

The half batteries continue to retire alternately, until the captain causes the firing to cease. The battery is afterwards aligned, or formed into line to the front or rear, by appropriate commands from the captain.

While retiring by half battery, the captain remains habitually with the portion of the battery nearest the enemy, and is accompanied by the chief of the centre section. The chief of the line of caissons accompanies the other half battery.

In **horse artillery**, the detachments move to the left, to facilitate the about of the caissons. They afterwards place themselves behind and follow them during the retrograde movement at the distance of 2 yards; remaining faced to the rear as long as the firing in retreat continues.

To fire retiring by half battery, commencing with the left, is executed according to the same principles, and by inverse means.

The movement may also be executed by sections; the sections retiring in succession, according to their positions in the battery.

MOVEMENTS FOR FIRING IN ECHELON.

552. When the battery is in line at a halt with pieces in front, to advance in echelon of pieces, the captain commands:

1. *By piece from the right—front into echelon.*

2. MARCH.

(PLATE 70.) At the last command, the right piece moves forward, followed by its caisson. The next piece moves forward in like manner as soon as its leaders are abreast the wheel horses of the rear carriage on the right; and the other pieces commence the movement in succession according to the same rule.

The officers preserve the same relative positions as in line.

When the battery is marching in line at a walk or trot, the echelon is formed according to the same principles, and by the

same commands; the gaits being regulated as in breaking sections.

The battery advances in echelon of pieces from the left according to the same principles, and by inverse means.

When the caissons are in front, the battery advances in echelon of pieces from the right or left according to the same principles, and by the same commands.

When the battery is in echelon, marching, or at a halt, it may be formed into battery to the front, rear, right, or left, as explained in Nos. 529, 530, 531, 532, and 533.

When firing in echelon to the front or rear, the direction of the fire may be changed to the right or left. For this purpose the captain orders the firing to cease, and commands: **ACTION RIGHT (OR LEFT.)** At this command, the trails of the pieces are turned to the left (or right,) and the limbers and caissons take their places in rear of the pieces. But if retiring with the prolonge fixed, the caissons stand fast, and the limbers back to allow the trails to be turned in the proper direction. The prolonge must be sufficiently slack to allow the recoil of the guns. This last method is only applicable to firing to the right when retiring by the right, and to the left when retiring by the left.

BEING IN ECHELON, TO FORM LINE.

553. The battery being in echelon at a halt, to form it into line, the captain commands:

1. *On the right (or left) piece—forward into line.*

2. **MARCH.**

The commands are repeated by the chiefs of sections. Each piece moves forward and establishes itself on the line, dressing on the piece indicated.

If the battery is in march, to form the line without halting, the commands are:

1. *Form line advancing, on right (or left) piece—trot.*

2. **MARCH.**

The pieces to the rear move forward at the increased gait, and take their positions in line.

To fire to the rear.

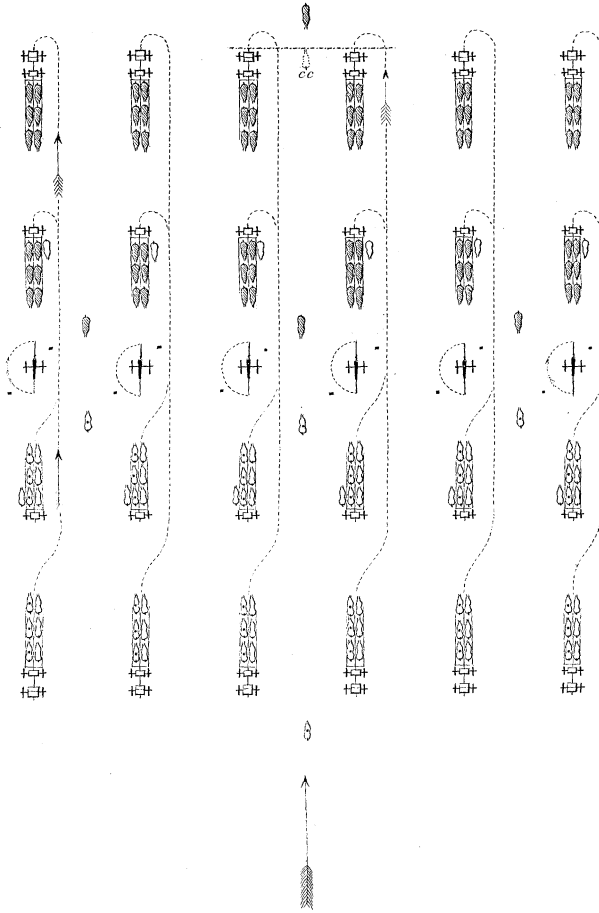

If the battery is in echelon and firing, to form it in the order in battery, continuing the fire, the captain causes the pieces behind the line on which the formation is to be made to cease their fire, and commands:

1. *On the right (or left) piece—forward into battery.*

2. MARCH.

At the first command, the chief of the right section places his left piece on the line, the right continuing its fire. The chiefs of the other sections cause them to be limbered to the front, and at the command MARCH, which they repeat, move them forward, and establish them in battery on a line with the right section.

TO FIRE TO THE REAR.

554. When the battery is firing, to fire in the opposite direction, the captain causes the firing to cease, and commands:

1. *Fire to the rear.*

2. *Limbers and caissons, pass your pieces—trot.*

3. MARCH.

(PLATE 71.) These commands are repeated by the chiefs of sections. At the command MARCH, the pieces are wheeled about by turning the trails to the left; and the limbers and caissons oblique to the right, pass them, and take their places in battery by a left reverse.

In horse artillery, the horses follow their limbers, pass them, and take their places by reversing to the left. When the horse holders cannot conduct them alone, they are assisted by Nos. 1 and 2.

When the pieces cannot be wheeled about by hand, the captain commands:

1. *Fire to the rear.*

2. LIMBER TO THE REAR.

3. *Caissons, pass your pieces—trot—MARCH.*

4. *Pieces, left about—MARCH.*

5. IN BATTERY.

ARTICLE SEVENTH.

CHANGES OF FRONT IN BATTERY.

CHANGE OF FRONT TO FIRE TO THE RIGHT, LEFT WING FORWARD, AND THE REVERSE.

555. WHEN the battery is firing, if the captain wishes to make a perpendicular change of front, to fire to the right, throwing forward the left wing, he discontinues firing, and commands :

1. *Fire to the right.*
2. *Change front forward on the right piece.*
3. MARCH.

(PLATE 72.) At the second command, the chief of the right section places the right piece in the new direction, by causing the trail to be moved to the left. He also causes the left piece of his section to be moved forward by hand, and established on the new line. When the ground is unmasked, the limbers and caissons of these pieces oblique to the left, move forward, and take their places in battery by wheeling to the right; the caissons aligning themselves by the chief of the line of caissons established on the right.

The other chiefs of sections cause their pieces to be limbered by the command, LIMBER TO THE FRONT; the caissons, and in horse artillery the horse holders also, closing upon the pieces while they are limbering. As soon as they are limbered, the chiefs of sections command: *Forward.*

At the second command, the chief of the line of caissons places himself on the left of the right piece of the centre section, facing to the front, to mark the right of the new line of caissons.

At the command MARCH, repeated by the chiefs of the centre and left sections, these sections move to the front; and, when each has arrived opposite its place on the new line, its chief

Change of front, to fire to the right, left, wing forward.

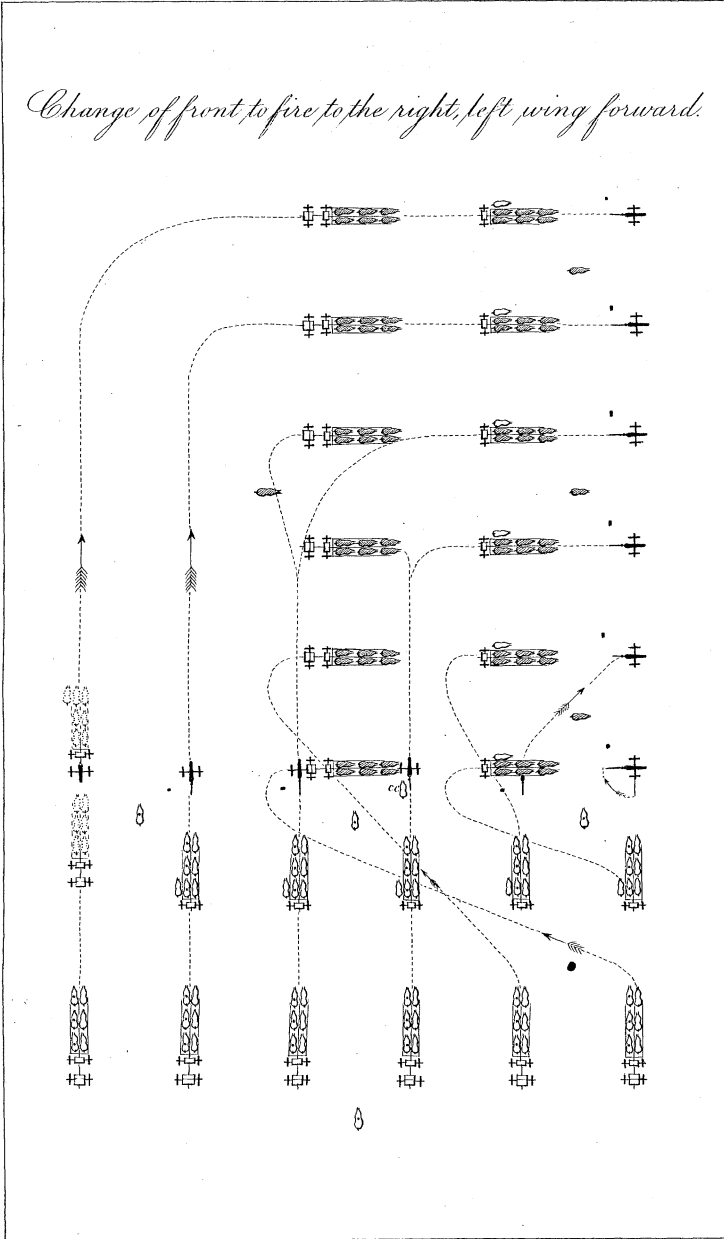

commands: *Section—right wheel—MARCH—FORWARD*; and afterwards, *In battery—MARCH*, so as to form upon the alignment of the right section. When the caisson of the right piece of the centre section reaches the point where its piece wheeled, it wheels to the left, takes its distance in rear, wheels about and dresses to the right upon the line of caissons.

The other caisson of the same section obliques to the left when its piece commences the wheel; and, after gaining its distance, establishes itself on the line by wheeling and dressing to the right.

When the pieces are too heavy to be moved or wheeled about by hand, the chiefs of sections cause them to be limbered, with the exception of the right piece, by the command **LIMBER TO THE REAR**. The chief of the right section then commands: *Piece, left about—caisson, forward*; and the chiefs of the other sections: *Pieces, left about—caissons, forward*. At the command **MARCH**, repeated by the chiefs of sections, the pieces are wheeled about and directed to the front by the command **FORWARD** from the chiefs of sections. The left piece of the right section is established on the line by the commands, *Right wheel—MARCH—FORWARD—In battery—MARCH*, from the chief of the section. The caisson wheels to the left when it reaches the point where its piece wheeled to the right; and, after taking its distance, wheels about and dresses to the right upon the chief of the line of caissons. The other sections are established upon the line as already described.

The pivot piece commences firing again, as soon as it is in position, and the others as they arrive on the line.

The change of front to fire to the left, right wing forward, is executed according to the same principles, and by inverse means.

In **horse artillery**, the detachments follow their pieces, and halt at the proper distance from the line. That of the left piece of the right section, when limbered, wheels to the left when its piece wheels to the right, allows its caisson to pass it, and takes its place by wheeling about to the left. The horse holders of the pieces not limbered oblique to the left with their limbers, and,

like them, take their places in battery by wheeling to the right. When it is deemed advisable, the captain may retain the cannoneers at their pieces, and allow all the horse holders to conduct their horses to the new line. The same may be done in the other changes of front.

CHANGE OF FRONT TO FIRE TO THE LEFT, LEFT WING FORWARD, AND THE REVERSE.

556. When the battery is firing, if the captain wishes to make a perpendicular change of front to fire to the left, throwing forward the left wing, he discontinues firing, and commands:

1. *Fire to the left.*
2. *Change front forward on the right piece.*
3. MARCH.

(PLATE 73.) At the second command, the chief of the right section causes the right piece to be placed in the new direction at once, by moving the trail to the right; and the limber and caisson of that piece will oblique to the right, and take their places in its rear by wheeling to the left; the caisson dressing upon the chief of the line of caissons. He also causes his left piece to be moved to its place and established on the line by hand; the limber of this piece, passing it on the right, takes its place by wheeling to the left, its caisson obliquing to the right, passes on the right, and in rear of the right caisson, and takes its place also by wheeling to the left.

The chiefs of the other sections cause them to be limbered to the front; and while limbering they command: *Caissons, pass your pieces—trot—MARCH.* When this is executed, the chief of the centre section commands: *Section—right wheel,* and that of the left: *Forward.*

At the command MARCH, repeated by the chiefs of the centre and left sections, these sections move as ordered, with the caissons leading. The centre section is conducted to the line by its chief, and formed by the commands, FORWARD and IN BATTERY. The left section advances 5 yards, and is conducted to the line by two

Change of front, to fire to the left, left wing forward.

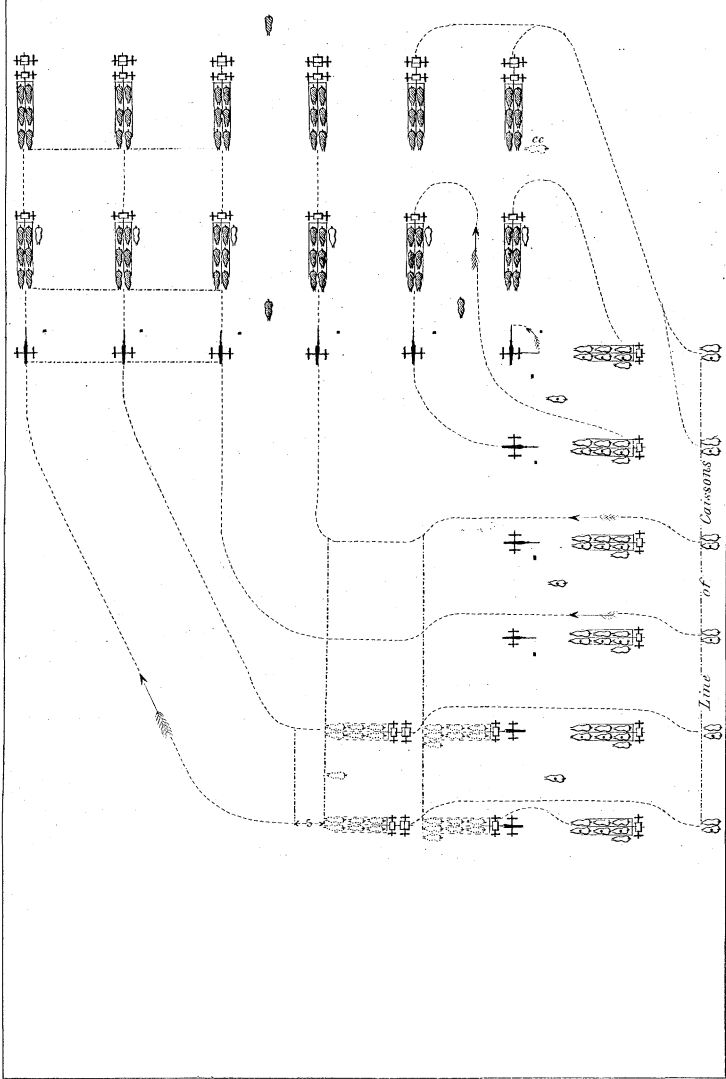

successive right half wheels. It is there formed in like manner upon the alignment of the right section.

At the second command from the captain, the chief of the line of caissons places himself in prolongation of the line, 32 yards on the right of the right piece, and faces to the front, to mark the left of the new line of caissons.

When the pieces are too heavy to be wheeled about or moved by hand, the chiefs of sections cause them to be limbered to the rear, with the exception of the right piece. While the pieces are limbering, the chiefs of the centre and left sections cause the caissons to pass as before; and all the chiefs of sections give the cautionary command for their pieces to wheel about. At the command MARCH, repeated by the chiefs of sections, the pieces are wheeled about, and the sections conducted to the new line by the appropriate commands. The caisson of the left piece of the right section takes its place in the same manner as when its piece is moved by hand.

The pivot piece recommences firing as soon as it is unmasked; and the others when they arrive on the line.

The change of front to fire to the right, right wing forward, is executed according to the same principles, and by inverse means.

In horse artillery, the horse holders of those pieces which are placed on the line by hand conduct the horses to their positions in battery by following their limbers.

CHANGE OF FRONT TO FIRE TO THE LEFT, LEFT WING TO THE REAR, AND THE REVERSE.

557. When the battery is firing, if the captain wishes to make a perpendicular change of front to fire to the left, throwing the left wing to the rear, he causes the firing to cease, and commands:

1. *Fire to the left.*
2. *Change front to the rear on the right piece.*
3. MARCH.

(PLATE 74.) At the second command, the chief of the right section places the right piece in the new direction, by causing the

trail to be moved to the right. He also causes the left piece of his section to be moved to the rear by hand and established on the new line. The limbers and caissons of these pieces move at once to the right, obliquing sufficiently to place themselves in rear of their respective pieces, and take their places by wheeling or reversing to the left.

The other chiefs of sections command: *Limber to the rear*, and immediately afterwards, *Caissons, in front of your pieces*—*trot*—MARCH. The caissons place themselves in front of their pieces, while they are limbering, and halt as prescribed in No. 472. The chief of the centre section then commands: *Section—left wheel*; that of the left section: *Section—forward*.

The chief of the line of caissons places himself in the prolongation of the line, 32 yards on the right of the right piece, and faces to the rear to mark the right of the new line of caissons.

At the command MARCH, given by the captain, and repeated by the chiefs of the centre and left sections, those sections are put in motion and placed in battery on the line, the chief of the left section wheeling it to the left when it is opposite its position.

When the pieces are too heavy to be moved by hand, the chief of the right section causes his left piece to be limbered to the rear with the rest, and then commands: *Left wheel*. At the command MARCH, repeated by this chief, the piece wheels to the left, and is conducted by him to its place by the commands, FORWARD—IN BATTERY. The caisson takes its place, as before described.

The pivot piece recommences firing as soon as it is unmasked; and the others when they arrive on the line.

The change of front to fire to the right, right wing to the rear, is executed according to the same principles, and by inverse means.

In horse artillery, the detachments, at the command IN BATTERY, take their places by the regular movement, described in No. 469. The horse holders of those pieces which are moved by hand follow their limbers and conduct the horses to their positions, by movements corresponding to those of their caissons. When the left piece of the right section is limbered, the horses

Change of front to fire to the left, left wing to the rear.

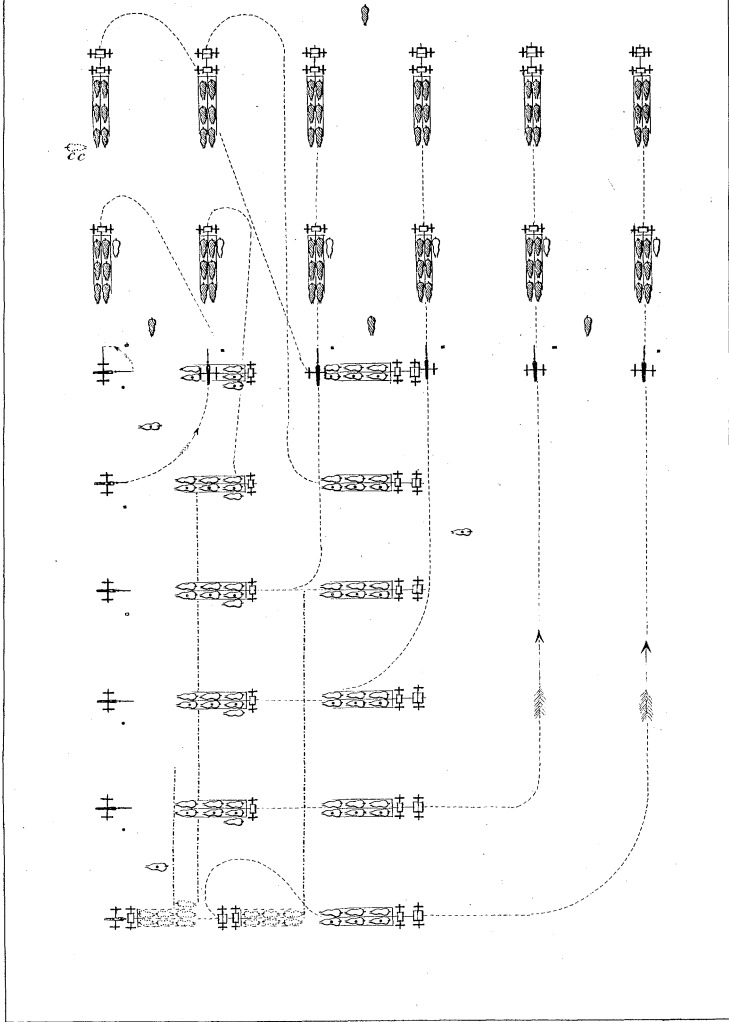

Change of front, to fire to the right, left wing to the rear.

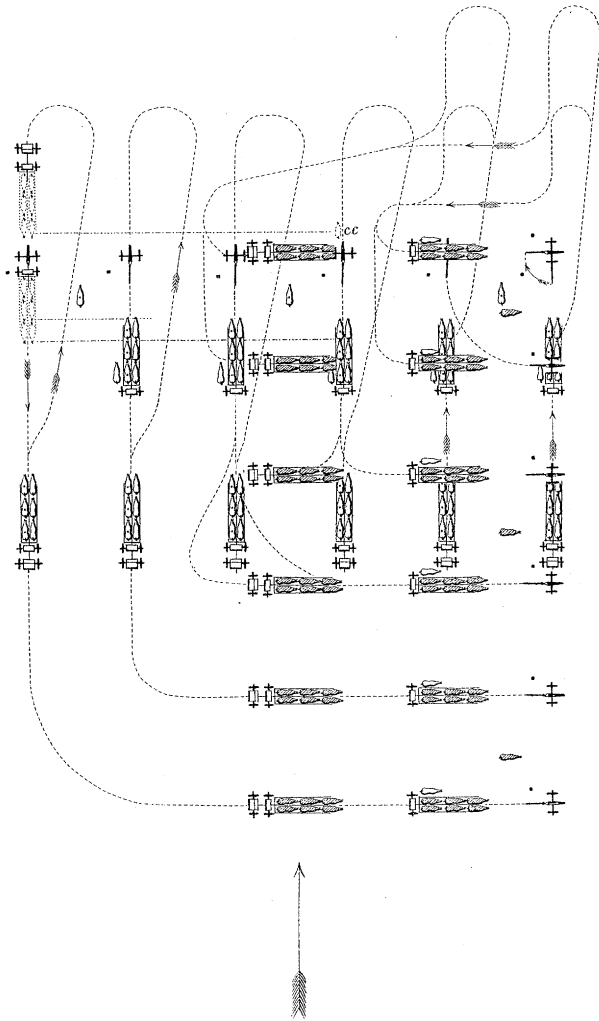

of the detachment are conducted to their places in the same manner as though the piece were unlimbered, except that the detachment mounts.

CHANGE OF FRONT TO FIRE TO THE RIGHT, LEFT WING TO THE REAR, AND THE REVERSE.

558. When the battery is firing, if the captain wishes to make a perpendicular change of front to fire to the right, throwing the left wing to the rear, he discontinues firing, and commands:

1. *Fire to the right.*
2. *Change front to the rear on the right piece.*
3. MARCH.

(PLATE 75.) At the second command, the chief of the right section commands: *Limbers and caissons, in rear of your pieces—trot—MARCH.* The limbers and caissons oblique to the right, and pass their pieces, with the limbers leading. As soon as the limbers have passed, they wheel twice to the left and cover their pieces. The caissons pass their limbers and cover them in like manner. The chief of the section causes the trail of his right piece to be moved to the left, and his left piece to be placed upon the new alignment by hand.

The chiefs of other sections command: **LIMBER TO THE REAR,** and *Caissons, in rear of your pieces—trot—MARCH.* When this is executed, they command: *Forward.*

At the second command, the chief of the line of caissons places himself on the left of the right piece of the centre section, facing to the rear, to mark the left of the new line of caissons.

At the command **MARCH,** from the captain, repeated by the chiefs of the centre and left sections, those sections, as well as the limbers and caissons of the first, are established upon the new line, as described in No. 555.

When the pieces cannot be moved by hand, the chief of the right section causes his left piece to be limbered like the rest; and then causes the remaining limber and the caissons to pass, as

before described. When the piece is limbered, he commands: *Left wheel*. At the command MARCH, from the captain, repeated by the chiefs of sections, the piece is wheeled and conducted to its place on the line, as in No. 555.

The pivot piece recommences firing as soon as it is placed in the new direction; and the others as they arrive on the line.

The change of front to fire to the left, right wing to the rear, is executed according to the same principles, and by inverse means.

In horse artillery, the horse holders of the pieces which are moved by hand follow their limbers, and wheel into their places in like manner. The remainder is executed as in No. 555.

TO PASS A DEFILE IN FRONT.

559. When the battery is firing, to pass a defile in front of the right section, the captain commands:

1. *To the front—by the right section—pass the defile.*

2. MARCH.

(PLATE 76.) At the first command, the chief of the right section discontinues firing, limbers his pieces to the front, and commands: *Forward*. At the command MARCH, repeated by this chief, who also commands: *Guide left*, the section moves forward, passes the defile, and is again established in battery, and the firing commenced by his command.

When the pieces are too heavy to be wheeled about by hand, the chief of the section causes them to be limbered to the rear, wheeled about, and the caissons closed, before giving the command *Forward*.

As soon as the right section commences firing, the centre is put in motion in like manner. Its chief conducts it through the defile by successive wheels, and forms it into battery in line with the first.

As soon as the centre section commences firing, the left passes in like manner.

While one section is passing the defile, the others continue firing; care being taken not to injure the section in advance.

In battery to pass a defile in front of the right wing.

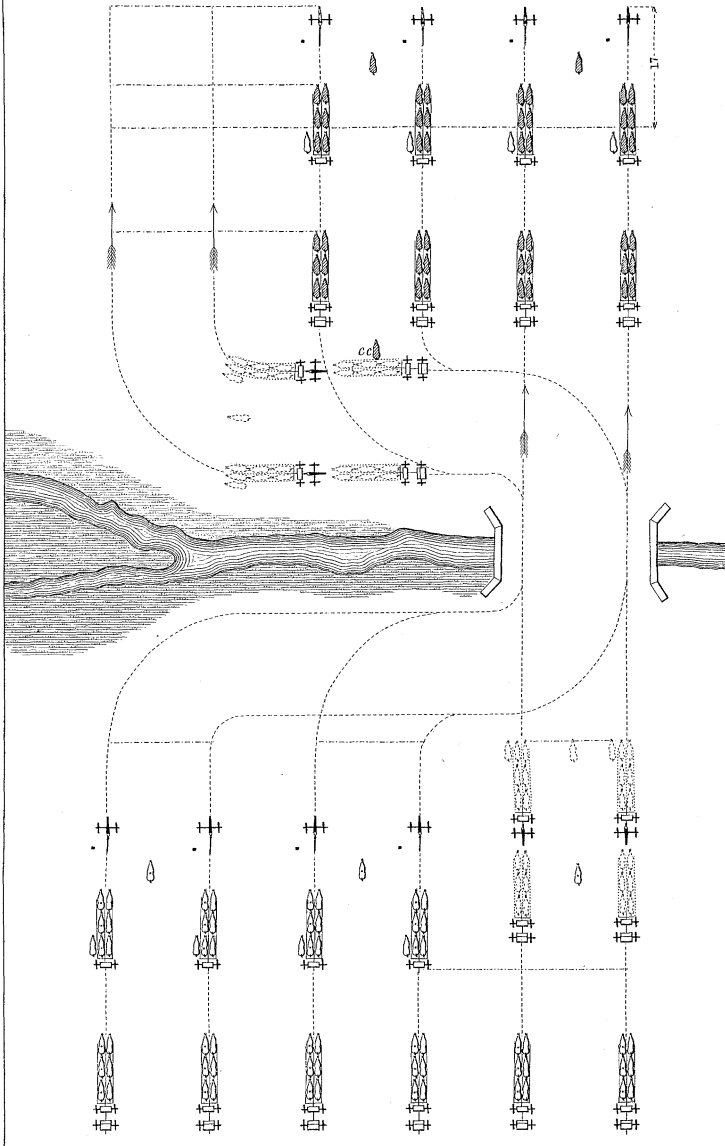

In battery to pass a defile, in rear of the centre.

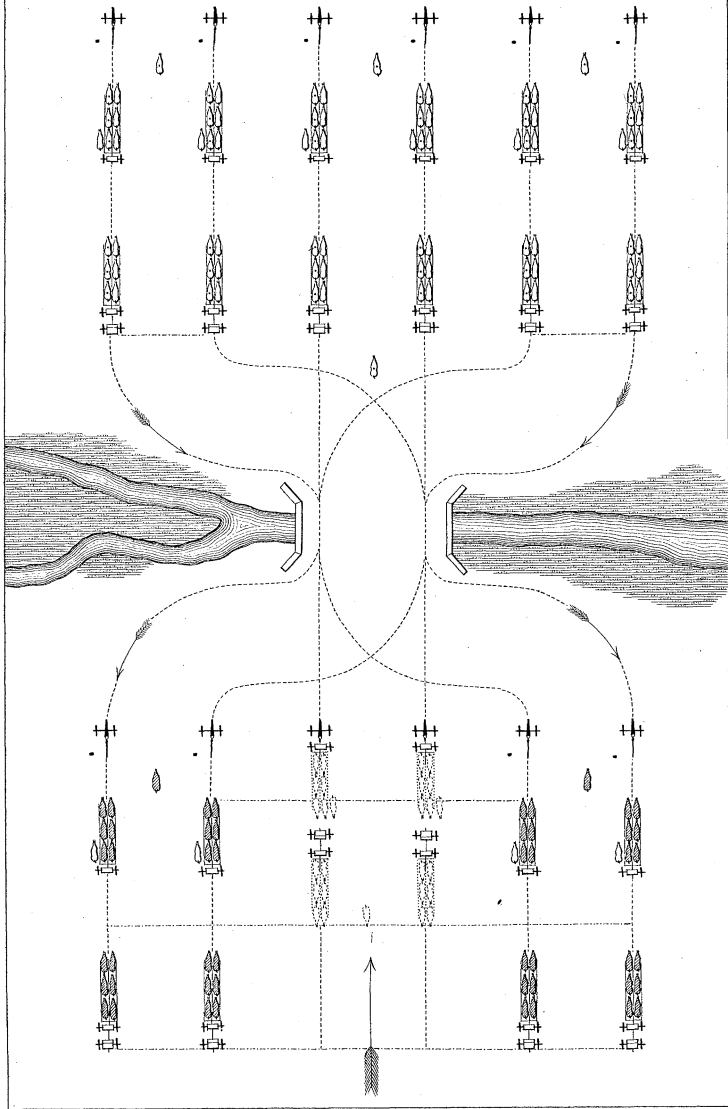

When the defile is in front of the left section, it is passed according to the same principles, commencing with that section.

When the defile is in front of the centre section, it is passed according to the same principles, commencing with that section, and by the commands, *To the front—by the centre section—pass the defile—MARCH.* Unless there is some reason to the contrary, the right section will pass before the left.

When the flank or oblique march is better suited to the nature of the ground, the chiefs of sections will give the required commands.

When the defile will admit but one piece at a time, the sections are broken by their chiefs in such a manner as to cause the nearest piece to enter first. The sections are re-formed by their chiefs immediately after passing the defile.

TO PASS A DEFILE IN REAR.

560. When the battery is firing, to pass a defile in rear of the centre section, the captain commands:

1. *To the rear—by the right section—pass the defile.*
2. MARCH.

(PLATE 77.) At the first command, the chief of the right section discontinues firing, limbers to the rear, and commands: *Caissons, left about—pieces, forward.* At the command MARCH, repeated by the chief of the right section, the caissons of that section execute the about, and the pieces close to their proper distance at a trot. As soon as the about is completed, the chief commands: FORWARD—*Guide left,* conducts the section through the defile by successive wheels, and forms it into battery in rear of its first position.

The left section is put in motion as soon as the right commences firing. It is conducted through the defile by its chief, and formed into battery in rear of its first position, by the principles already described.

The centre section moves as soon as the left commences firing.

It is formed into battery in rear of its first position, and in line with the other two sections.

The passage of the defile may be executed, commencing with the left section, according to the same principles, and by inverse means.

When the defile is in rear of one of the flanks, the movement should commence with the other. It should always end by passing the section or piece covering the defile.

When the defile will admit but one piece at a time, the sections are broken by their chiefs in such a manner as to cause the piece farthest from the defile to enter first; and the sections are again formed, as soon as possible after leaving the defile.

PARADE FOR REVIEW AND INSPECTION.

561. The battery being in line, with the pieces in front; the first sergeant 2 yards from the right; the bugler and guidon in one rank, 6 yards on his right; the quartermaster-sergeant 2 yards from the left; the artificers in one rank, 6 yards on his left; all dressed on the lead drivers of the pieces; the captain commands:

1. ATTENTION.
2. *Prepare for review*
3. ACTION FRONT.
4. *Right-DRESS.*
5. FRONT.

(PLATES 78, 79.) At the third command, the battery is formed as directed; the chiefs of sections take their places in the centres of their sections, 3 yards in front of the line of muzzles; and the chiefs of pieces, without dismounting, take their places at their posts, *in battery*. The non-commissioned staff, buglers, guidon, and artificers reverse with the limbers, and take their places, in the order already directed, on a line with the lead drivers; the cannoneers are at their posts.

At the fourth command, the battery is aligned—the chiefs of sections, the pieces, and the limbers by the captain; and the caissons by the chief of the line of caissons.

Parade for Review and Inspection.

Mounted Battery.

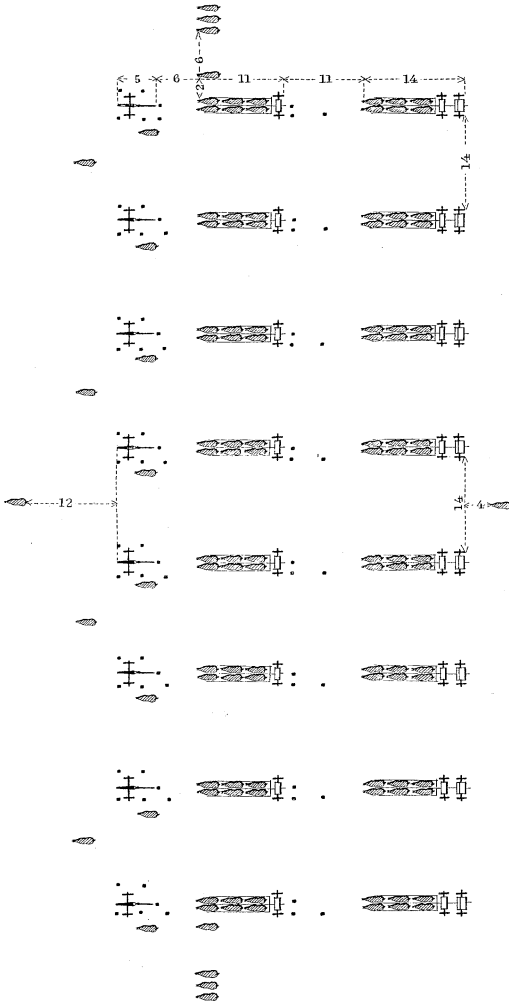

Parade for Review and Inspection.

Horse Artillery.

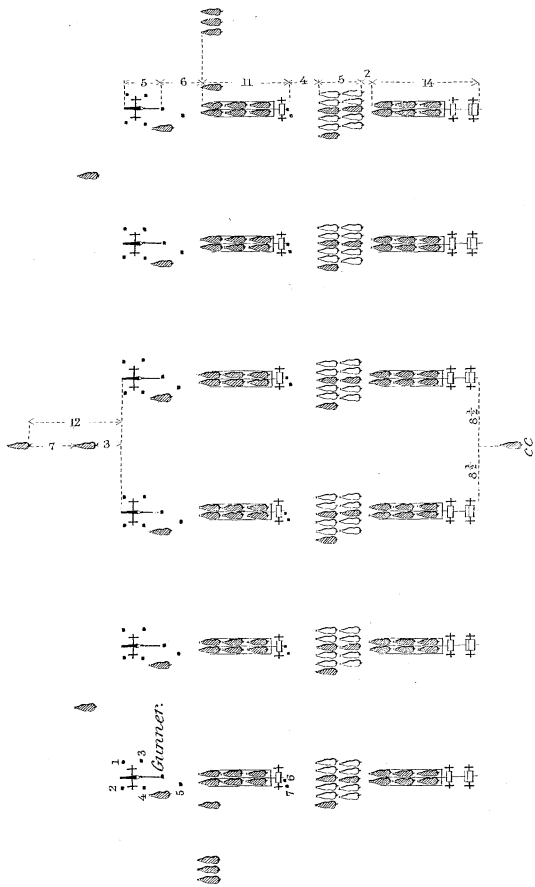

At the fifth command, given by the captain when the alignment is completed, the chief of the line of caissons takes his position *in battery*. The captain then commands :

Draw—SABRES.

This is executed by the staff sergeants, chiefs of pieces, and artificers only; and the captain takes post 12 yards in front of the centre of the battery, (8 yards, if there are two or more batteries in line,) faces to the front, and awaits the approach of the reviewing officer.

When the reviewing officer is midway between the camp-color and the captain, the latter reverses to the right, and commands :

Present—SABRES.

He immediately resumes his front and salutes, as do all whose sabres are drawn; and the music plays according to the rank of the reviewing officer.

The reviewing officer having halted, and acknowledged the salute, the captain brings his sword to a carry, reverses as before, and commands :

Carry—SABRES.

He immediately resumes his front; the reviewing officer turns off to the right of the battery, passes along its front, and returns to the right by passing between the lines of carriages, or in rear of the caissons.

While the reviewing officer is passing around the battery, the music plays. It ceases when he turns off to take his post at the camp-color.

When the music ceases, the captain faces the battery, and commands :

LIMBER TO THE FRONT,

and all assume their places in line.

The reviewing officer having taken a position near the camp-color, the captain causes the cannoneers to mount, and breaks the battery into column of sections to the right by the usual commands.

He then commands :

Pass in review,

and puts the column in march, at a walk, with the guide to the right.

The captain then places himself at the head of the column, 4 yards in advance of the chief of the leading section; the trumpeters or buglers march 4 yards in advance of the captain; the chief of the line of caissons outside the column, opposite the centre, and 4 yards from the left flank; the first sergeant and quartermaster-sergeant outside the column, 4 yards from the left flank, the former abreast the lead drivers of the leading section, the latter abreast the lead drivers of the rear section; the artificers in one rank, 4 yards in rear of the column; the guidon at the side of the chief of the directing piece.

When the head of the column has arrived within 40 yards of the reviewing officer, the music begins to play, and as soon as the latter has passed, it wheels out of the column to a position in front of the reviewing officer, where it faces him, and continues to play until the column has passed. It then ceases, follows in rear of the battery, and resumes its place at the head of the column, after the next change of direction.

All the officers salute in succession, as they arrive within 6 yards of the reviewing officer, casting their eyes towards him at the same time, and bringing their sabres to a carry after having passed him 6 yards. As soon as the captain has saluted he places himself on the left of the reviewing officer, passing by his rear, remains until the battery has passed, and then rejoins it, again passing by the rear.

The column is so conducted as to march parallel to the line on which the battery is to form, and far enough in its rear to enable the column to wheel into line. It is then wheeled into line, formed in battery, and the review terminated by a salute as at the beginning.

When instructions have been previously given, to pass a second time, either at a trot or gallop, it will be done before wheeling into line, the officers passing the second time without saluting.

562. **When artillery is reviewed with other troops, the pieces, on coming into battery, are dressed on them, the wheels**

being in the prolongation of the line of the front rank, the chiefs of sections place themselves on the line of company officers, and the captain on the line of field officers.

At the command, **CLOSE ORDER**, instead of limbering to the front, the captain commands:

1. **LIMBER TO THE REAR.**
2. *Pieces, left about—Caissons, forward.*
3. **MARCH.**
4. *Battery—HALT.*

These commands are executed, and the pieces halt with their lead drivers on a line with the other troops.

After passing in review and reaching the ground on which it is to form, the battery may be wheeled by section to the right, and after gaining the necessary distance to the rear, countermarched, and established on the line.

563. When a battery is to march past in line or in column of half batteries, it will be done according to the principles already described. *In line*, the officers, etc. will be at their usual posts. *In column of half batteries*, the captain will be 2 yards in advance of the chief of the leading half battery; each chief of half battery 2 yards in front of the centre of his command; the chief of the centre section on the left of the leading half battery 4 yards from its centre, and the chief of the line of caissons in the same position with respect to the rear half battery.

In eight-gun batteries, when the column is formed by half battery, the chiefs of sections who do not command half batteries retain their places in their sections.

The buglers are 4 yards in front of the captain. The first serjeant and quartermaster-serjeant are outside the column of half batteries, 4 yards from the left flank, the former abreast the lead driver of the leading, the latter abreast the lead driver of the rear half battery, the artificers in one rank, 4 yards in rear of the column, the guidon at the side of the chief of the directing piece.

OFFICERS' SALUTE WITH THE SABRE.

564. When officers are to salute, whether on horseback or on foot, at a halt or in march, they execute it in four motions :

1st. At 6 yards from the person to be saluted, raise the sabre perpendicularly, the point upwards, edge to the left, the hand opposite to and 1 foot from the right shoulder, the wrist 6 inches from the body.

2d. Lower the blade, extending the arm to its full length, the hand *in quarte*, until the point of the sabre is near the foot.

3d. Raise the sabre quickly, the point upwards as in the first motion, after the person saluted is passed 4 yards.

4th. Bring the sabre to a carry.

INSPECTION.

565. Batteries of field artillery will always, for inspection, be formed either in line or in battery.

The knapsacks of the cannoneers are strapped on the footboards of the ammunition chests. If the inspector wishes to examine the clothing of the men on the field, the knapsacks and valises will be unstrapped, laid at the feet of the men and opened, the drivers being dismounted for the purpose.

THE END.

Loops.

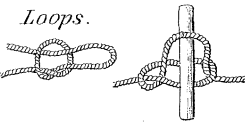

Square Knot.



Bow Knot.



Single Knot.



Weaver's Knot.



German Knot. 2 Half Hitches or Artificer's Knot.

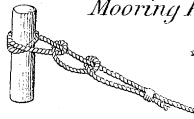
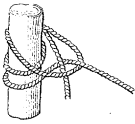

Mooring Knots.

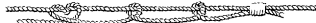

Capstan or Prolonge Knot.

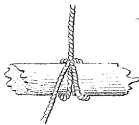

Hitches.

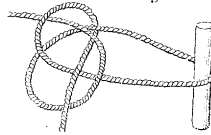

Becket Knot.



Anchor Knot.

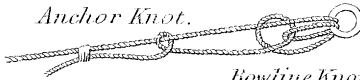

Bowline Knot.



Short Splice.

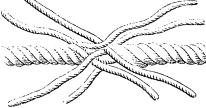

Long Splice.



BUGLE SIGNALS.

1. MARCH FOR REVIEW.

Musical notation for the first bugle signal, '1. MARCH FOR REVIEW.' It consists of six staves of music in common time (C). The melody is written in a single treble clef. The first staff begins with a quarter rest followed by a series of eighth and sixteenth notes. The piece concludes with a double bar line and repeat dots.

2. WALK.

Musical notation for the second bugle signal, '2. WALK.' It is a single staff of music in 2/4 time. The melody consists of four notes: a quarter note, a dotted quarter note, a quarter note, and a quarter note, ending with a double bar line and repeat dots.

3. TROT.

Musical notation for the third bugle signal, '3. TROT.' It is a single staff of music in 2/4 time. The melody features a series of eighth notes and quarter notes, ending with a half note and a quarter note, followed by a double bar line and repeat dots.

4. GALLOP.

Musical notation for the fourth bugle signal, '4. GALLOP.' It is a single staff of music in 2/4 time. The melody consists of eighth and sixteenth notes, ending with a half note and a quarter note, followed by a double bar line and repeat dots.

5. HALT.



6. FORWARD.



7. HEAD OF COLUMN TO THE RIGHT.

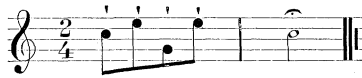

8. HEAD OF COLUMN TO THE LEFT.



9. RIGHT OBLIQUE.

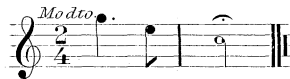

10. LEFT OBLIQUE.



11. ABOUT.



12. COUNTERMARCH.



13. DRIVERS MOUNT.



14. DRIVERS DISMOUNT.



15. CANNONEERS MOUNT.



16. IN BATTERY.



17. COMMENCE FIRING.



18. CEASE FIRING.



19. BOOTS AND SADDLES.



20. THE GENERAL.

Vivace.

The musical score for '20. THE GENERAL.' is written in 3/4 time and consists of seven staves. The tempo is marked 'Vivace'. The melody is characterized by frequent triplet patterns, indicated by a '3' above the notes. The piece concludes with a double bar line.

21. TO HORSE.

Presto.

The musical score for '21. TO HORSE.' is written in common time (C) and consists of one staff. The tempo is marked 'Presto'. The melody features a triplet pattern, indicated by a '3' above the notes. The piece concludes with a double bar line.

22. ASSEMBLY.

Alto. moderato.

The musical score for '22. ASSEMBLY.' is written in common time (C) and consists of two staves. The tempo is marked 'Alto. moderato.'. The melody is written across both staves and concludes with a double bar line.

23. THE REVILLE.

110 = *Allegro.*

Musical notation for 'THE REVILLE' in 2/4 time, marked *Allegro.* The piece consists of three staves of music. The first staff begins with a treble clef, a key signature of one flat, and a tempo marking of 110. The music features a rhythmic pattern of eighth and sixteenth notes. The second staff continues the melody with some rests. The third staff concludes the piece with a double bar line and the marking *D.C.*

24. STABLE CALL.

Allegro.

Musical notation for 'STABLE CALL' in 6/8 time, marked *Allegro.* The piece consists of three staves of music. The first staff begins with a treble clef, a key signature of one flat, and a tempo marking of *Allegro.* The music features a rhythmic pattern of eighth and sixteenth notes. The second staff continues the melody with some rests. The third staff concludes the piece with a double bar line and the marking *D.C.* and the word *fine*.

25. WATERING CALL.

Allegro. 3

Musical notation for 'WATERING CALL' in common time, marked *Allegro.* The piece consists of a single staff of music. The music features a rhythmic pattern of eighth and sixteenth notes. The piece concludes with a double bar line and the marking *3*.

26. BREAKFAST.

Allegro.

Musical notation for 'BREAKFAST' in 2/4 time, marked *Allegro.* The piece consists of two staves of music. The first staff begins with a treble clef, a key signature of one flat, and a tempo marking of *Allegro.* The music features a rhythmic pattern of eighth and sixteenth notes. The second staff continues the melody with some rests. The piece concludes with a double bar line and the marking *3*.

27. ASSEMBLY OF BUGLER'S.

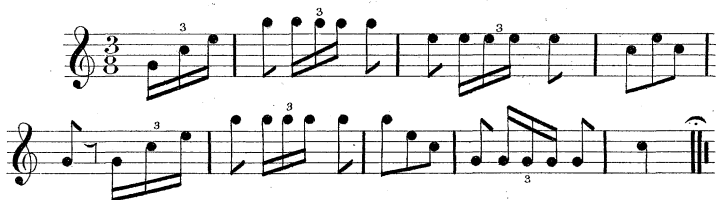

28. ASSEMBLY OF GUARD.

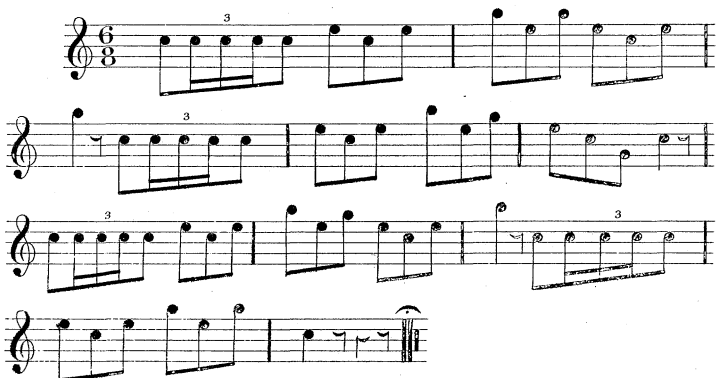

29. FATIGUE CALL.

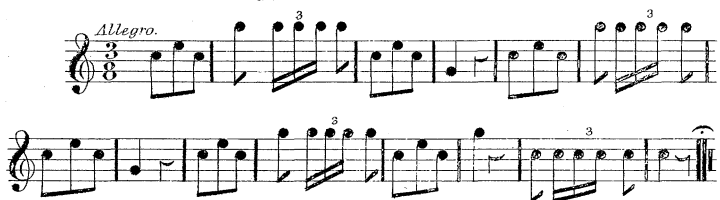

30. DRILL CALL.

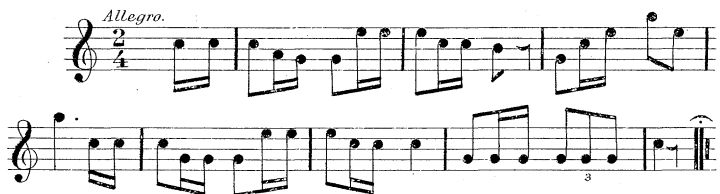

31. DINNER CALL.

Allegro

Musical notation for '31. DINNER CALL.' in 2/4 time, marked *Allegro*. The piece consists of two staves of music. The melody is characterized by frequent triplet patterns, indicated by a '3' above the notes. The piece concludes with a double bar line.

32. SICK CALL.

Musical notation for '32. SICK CALL.' in 2/4 time. The piece consists of two staves of music. The melody features several triplet patterns, marked with a '3' above the notes. The piece ends with a double bar line.

33. TATTOO.

1^{mo.}

2^{do.}

3^{xio.}

Musical notation for '33. TATTOO.' in common time (C). The piece is presented in three parts: *1^{mo.}*, *2^{do.}*, and *3^{xio.}*. Each part is written on a separate staff. The *1^{mo.}* part is the most melodic, while the *2^{do.}* and *3^{xio.}* parts provide a rhythmic accompaniment. The piece concludes with a double bar line.

