



This is a digital copy of a book that was preserved for generations on library shelves before it was carefully scanned by Google as part of a project to make the world's books discoverable online.

It has survived long enough for the copyright to expire and the book to enter the public domain. A public domain book is one that was never subject to copyright or whose legal copyright term has expired. Whether a book is in the public domain may vary country to country. Public domain books are our gateways to the past, representing a wealth of history, culture and knowledge that's often difficult to discover.

Marks, notations and other marginalia present in the original volume will appear in this file - a reminder of this book's long journey from the publisher to a library and finally to you.

Usage guidelines

Google is proud to partner with libraries to digitize public domain materials and make them widely accessible. Public domain books belong to the public and we are merely their custodians. Nevertheless, this work is expensive, so in order to keep providing this resource, we have taken steps to prevent abuse by commercial parties, including placing technical restrictions on automated querying.

We also ask that you:

- + *Make non-commercial use of the files* We designed Google Book Search for use by individuals, and we request that you use these files for personal, non-commercial purposes.
- + *Refrain from automated querying* Do not send automated queries of any sort to Google's system: If you are conducting research on machine translation, optical character recognition or other areas where access to a large amount of text is helpful, please contact us. We encourage the use of public domain materials for these purposes and may be able to help.
- + *Maintain attribution* The Google "watermark" you see on each file is essential for informing people about this project and helping them find additional materials through Google Book Search. Please do not remove it.
- + *Keep it legal* Whatever your use, remember that you are responsible for ensuring that what you are doing is legal. Do not assume that just because we believe a book is in the public domain for users in the United States, that the work is also in the public domain for users in other countries. Whether a book is still in copyright varies from country to country, and we can't offer guidance on whether any specific use of any specific book is allowed. Please do not assume that a book's appearance in Google Book Search means it can be used in any manner anywhere in the world. Copyright infringement liability can be quite severe.

About Google Book Search

Google's mission is to organize the world's information and to make it universally accessible and useful. Google Book Search helps readers discover the world's books while helping authors and publishers reach new audiences. You can search through the full text of this book on the web at <http://books.google.com/>

War 1408.60.7



Harvard College Library

FROM

David Heald.

G. A. Hill
3^d Artillery
N. Y. C.

1857



Handwritten text in a cursive script, possibly Urdu or Persian, oriented vertically on the page.

P. H. 111

INSTRUCTION
FOR
FIELD ARTILLERY,
HORSE AND FOOT.

U.S. - Wardept.

INSTRUCTION

FOR

FIELD ARTILLERY,

HORSE AND FOOT.

COMPILED BY A BOARD

OF

ARTILLERY OFFICERS.

BALTIMORE:
JOSEPH ROBINSON.

1845.

Wan 1408.60.7



David Beaid,
Watertown.

WAR DEPARTMENT,

March 6, 1846.

The system of Instruction for Field Artillery, prepared by a Board of Army Officers, pursuant to orders from the General-in-Chief, having been approved by the PRESIDENT, is herewith published for the information and government of the army; and under the Act of May 12, 1820, for the observance of the Militia of the United States.

With a view to insure uniformity throughout the army, all exercises and manœuvres not embraced in this system are prohibited, and those herein prescribed will be strictly observed.

W. M. WILKINS,

Secretary of War.

CONTENTS.

SCHOOL OF THE PIECE.

	Page
Method of instructing and telling off the detachments	13
Posts of the detachment	14
Method of mounting and dismounting the detachments	16
Change of position of detachments	18
Service of ordnance with detachments of different strengths	20
Method of performing the duties of serving ordnance	21
Pointing and ranges	28
Limbering	33
Unlimbering and coming into action	33
Moving the piece by hand	34
Moving and firing with the prolonge	35
Exercise of several pieces	37
Changing wheels	38
Dismounting pieces	40
Mounting pieces	42
Carrying pieces	44
Dismounting carriages	45
Mounting carriages	45
Righting carriages that have been overturned	46
Exercise with bricoles and drag-ropes	47

NOMENCLATURE.

	Page
6 Pdr. Gun (Bronze)	1
24 Pdr. Howitzer (Bronze)	2
Gun carriage	3 & 4
Limber	5 & 6
Battery Wagon	7 & 8
Forge	9 & 10
Harness	11

SCHOOL OF THE DRIVER.

PART FIRST.

	Page
Method of instruction	51
Loading the horses to the exercise ground and coupling	51
To mount	52
Use of the coupling rein and whip	53
Wheeling	53

	Page
About	53
Oblique	54
To rein back	54
To march to the front, and to a flank	54
To dismount	55
To file off	55

PART SECOND.

Method of instruction	55
Arrangement of the teams	56
To break into column	56
To enter the park	56
Hitching in	57
To unpark	58
To halt	59
Exercise at a halt—To wheel into line	60
To oblique	60
The about	60
To reverse	61
To rein back	61
To rein back to the right or left	62
To march and to halt	62
To change direction on a march	62
To execute the about when marching in column	63
To rest	63
To pass from the walk to a trot, and the reverse	64
To pass, successively, from the rear to the head of the column	64
From a halt, to march at a trot, and the reverse	65
To pass from the trot to the trot out	65
To dismount whilst marching	65
To mount whilst marching	65
To park	66
To unhitch	67
To leave the park	67

SCHOOL OF THE BATTERY.

General remarks	69
Manœuvres of a field battery	73
Composition of the battery of manœuvre	73
Posts of the cannoneers during the manœuvres	77
Formations of the battery	77
Remarks on the formations of the battery	80
Measures of the elements composing a battery and of its formations	81
Manning the battery	82

CONTENTS.

	Page
To unpark	83
To halt	84
Change of gait	84
To form sections	85
The battery being in column of pieces, to form the caissons on the flank	87
To march in column	87
To halt the column	88
To change the gait	88
To march by a flank	88
Oblique march	89
Passage of carriages in column	91
About in column	92
Countermarch in column	92
To change direction in column	93
To diminish the front of a column on the march	93
In column with the caissons on the flank, to replace them in front or rear	95
To form the park	95

TO PASS FROM THE ORDER IN COLUMN TO THE
ORDER IN LINE, AND THE REVERSE.

Into line to the front	96
Into line face to the rear	97
Into line to the right or left	98
Into line on the right or left	98
To break into column to the front	99
To break into column to the rear	100
To break into column to the right or left	100
To break into column to the front, from one flank, to march towards the other	101
To break into column to the rear, from one flank, to march towards the other	101
To break into column to the front, when the battery is marching in line	101
To form line advancing	103
To form double column on the centre section	103
To deploy the double column forward into line to the front	105
From double column to form line advancing	107
To form the double column into line to the right or left	107
To advance in line	108
To halt the battery and align it	109
Changes of gait	109
To march by a flank	110
Oblique march	110
Passage of carriages in line	110
About in line	110

	Page
Countermarch in line	110
To change direction in line	110
To close intervals in line	112
The about, or countermarch, with diminished intervals	112
To resume intervals	113
Passage of obstacles	114

FORMATIONS IN BATTERY.

In line with pieces in front to form into battery to the front	114
In line with pieces in front, to form into battery to the front by throwing the caissons to the rear	116
In line with caissons in front, to form into battery to the front	116
In line with pieces in front, to form into battery to the rear	117
In line with caissons in front, to form into battery to the rear	118
In battery to form into line to the front	119
In battery to form into line to the rear	120
In column with pieces in front to form into battery to the front	122
In column with caissons in front to form into battery to the front	122
In column with pieces in front to form into battery to the rear	123
In column with caissons in front to form into battery to the rear	124
In column with pieces in front to form into battery to the right or left	125
In column with caissons in front to form into battery to the right or left	126
In column with pieces in front to form into battery on the right or left	127
In column with caissons in front to form into battery on the right or left	128
To deploy the double column into battery to the front or rear	129
To deploy the double column into battery to the right or left	129
To pass from the order in battery to the order in column	130
To march by a flank	130

FIRINGS.

To fire advancing	133
To fire in retreat	134
Movements for firing in echelon	135
To fire to the rear	136

CHANGES OF FRONT IN BATTERY.

Change of front to fire to the right, left wing forward, and the reverse	137
Change of front to fire to the left, left wing forward and the reverse	139
Change of front to fire to the left, left wing to the rear and the reverse	142
Change of front to fire to the right, left wing to the rear and the reverse	142
To pass a defile in front	144
To pass a defile in rear	145

CONTENTS.

xi

PARADE FOR REVIEW AND INSPECTION.

	Page
Review	146
Inspection	149

ORDER OF ENCAMPMENT OF A BATTERY OF ARTILLERY.

1st mode	150
2d mode	151

SUPPLEMENT.

Remarks	152
Marches	153
Ascents	154
Descents	155
To cross swampy ground	156
To pass a ditch	156
To cross fords	156
To pass military bridges	157
Reversing a battery in a narrow road	158
In action, or preparing for action	158
Replacing killed, or disabled horses	160
Instruction for the preservation of harness	160
Interior management of a battery	162
BUGLE SIGNALS	164

SCHOOL OF THE PIECE.

METHOD OF INSTRUCTING AND TELLING OFF THE DETACHMENTS.

THE instructor should bear in mind that in every change of numbers at the gun exercise, each recruit has to learn different duties, and to handle different implements from those he was previously engaged with; and these again vary with the several natures of ordnance and machines, all which an artillery man must be master of. It is therefore impossible that such a variety of exercises can be well executed, or even remembered, unless the recruit is made to comprehend the object and motive of the various duties he is called upon to perform.

For the purpose of instructing the recruit, each detachment is to be formed in front of the piece unlimbered, and the different numbers are to be called upon successively to perform their respective duties in *detail*, while the rest of the detachment look on and observe their motions; and when it is found difficult to make the recruit sensible of the defect of his position, &c. the instructor will place himself or another recruit in the correct position.

Great patience and the utmost precision are necessary on the part of the instructor. He should especially endeavor to excite a spirited and active deportment in the recruits at every military exercise; and, above all, be particularly careful not to disgust them by too long an application to any one point in the drill.

In the service and exercise of the various descriptions of ordnance, the same numbers, as far as possible, always perform the same duties, the detachments being told off upon the same principle.

It is presumed that not less than six men, unless from necessity, will be posted with any description of field ordnance. When the detachment consists of less than six men, the higher numbers are struck out, and additional duties are imposed upon those remaining. When drag-ropes or bricoles are used, the numbering will be continued from the then highest number of the detachment.

The detachment falls in two deep in close order; the men are so placed that they may be told off to the duties for which they are most fit. This of course does not apply to recruits, each of whom must be taught the duties of every number. The detachment is composed of nine men in foot, and eleven men in horse artillery, including the gunner, who should be, if practicable, a non-commissioned officer.

The gunner tells the detachment off from the right; No. 1 being on the right of the rear rank, No. 2 on the right of the front, No. 3 on the left of No. 1, No. 4 on the left of No. 2, and so on; the even numbers being in the front, and the odd numbers in the rear rank. No. 8 is told off as chief of caisson, and the detachment is divided into sections. With drag-ropes or bricoles the numbering and posting will be continued in the same manner.

When the chief of the piece is not mounted, he performs the duty of telling off, and the gunner is posted in front of No. 5, and No. 6 in front of No. 7.

In *horse artillery* the gunner is posted in front of No. 5, No. 6 in front of 7, No. 9 in the centre of the rear, and No. 10 in the centre of the front rank.

POSTS OF THE DETACHMENT.

1. *Piece unlimbered.* The gunner is at the end of the trail handspike. Nos. 1 and 2 are about two feet outside the wheels, No. 1 on the right and No. 2 on the left; with howitzers rather in rear of the muzzle; with

guns in line with the front part of the wheels. Nos. 3 and 4 are in line with the knob of the cascable, covering Nos. 1 and 2. No. 5 is five yards in rear of the left wheel, No. 6 in rear of the limber, and No. 7 on his left covering No. 5. No. 8, the chief of the caisson, is four yards in rear of the limber and on its left. All face to the front, which with the piece unlimbered, is in the direction of the muzzle.

The chief of the piece is opposite the middle of the trail handspike, outside and near the left cannoners.

2. *Piece limbered.* Nos. 1 and 2 are opposite the muzzle; Nos. 3 and 4 opposite the knob of the cascable; the gunner and No. 5 opposite the rear, and Nos. 6 and 7 the front part of the limber wheels. No. 8 is on the left and opposite the limber box of the caisson. All face to the front, which is in the direction of the pole, and cover each other on lines one yard from the wheels; the even numbers on the right, and the odd numbers on the left. The chief of the piece is on the left, and, if not mounted, opposite the end of the pole; if mounted, he is near the leading driver.

3. *In front.* The detachment is in line ten yards in front of the leading horses, or end of the pole when the horses are not hitched in; the gunner on the right, and the centre of the detachment opposite the end of the pole.

4. *In rear.* The detachment is in line two yards in rear of the muzzle; the gunner on the right, and the centre of the detachment opposite the muzzle.

5. *On the right or left.* The detachment is in line opposite the limber axletree, and three yards from it; the gunner on the right. *In horse artillery* the detachment is in line with the leading horses and three yards from them.

The chief of the piece, when not mounted, takes the place of the gunner with the *detachment in front or rear, on the right or left*; the latter taking post in front of No. 5.

6. *Mounted with three boxes.* The gunner and Nos. 5 and 6 are on the limber box, the gunner on the right and No. 5 on the left. Nos. 1, 2, and 7 are on the limber box of the caisson, No. 2 on the right and No. 1 on the left. Nos. 3, 4, and 8 are on the centre box of the caisson, No. 4 on the right and No. 3 on the left.

7. *With four boxes.* Nos. 6 and 7 are on the rear box of the caisson, No. 6 on the right. The other numbers as before.

METHOD OF MOUNTING AND DISMOUNTING THE DETACHMENTS.

8. *Mounting with three boxes.* The instructor halts the carriages, if not already at a halt, and commands :

1. *Prepare to Mount.*
2. MOUNT.

At the first command the cannoneers run to their respective places, and stand facing the boxes upon which they are to mount. The gunner and No. 5 in rear of the gun limber, No. 6 on the right of the gunner. Nos. 1 and 2 in rear of the caisson limber, No. 7 on the left of No. 1, Nos. 3 and 4 in front of the centre box of the caisson, No. 8 on the right of No. 3. The gunner and Nos. 2 and 3 seize the handles with the right hand, and step upon the stocks with the left foot, and Nos. 5, 1, and 4 seize the handles with the left hand, and step upon the stocks with the right foot.

At the second command, the gunner and Nos. 1, 2, 3, 4, and 5 spring into their seats, the gunner and Nos. 5, 1, and 2 with their backs to the front.

No. 8 then springs into his seat in the same manner as No. 3, and Nos. 6 and 7 step in rear of their boxes, place their hands upon the knees of the men already mounted, step upon the stocks with their nearest feet, and springing up, step over the boxes and take their seats. The gunner and Nos. 5, 1, and 2 then face about

to the front by throwing their legs outwards over the handles.

When the word MOUNT is given by itself, the men run to their places and spring into their seats at once; No. 8 taking his seat before No. 3.

9. *Mounting with four boxes.* At the command *Prepare to mount*, Nos. 6 and 7 run to the rear box of the caisson; No. 6 takes hold of the handle with the right, and No. 7 with the left hand; No. 6 steps upon a spoke of the wheel with the right, and No. 7 with the left foot. At the command MOUNT, both spring into their seats, and sit with their backs to the front. The other numbers mount as before.

In mounting, Nos. 3, 4, and 8 will step upon the spokes of the wheel with the nearest feet, when they find it easier than to step upon the stock.

When there are steps upon the carriages for Nos. 3, 4, 6, 7, and 8, they will use them with the feet most convenient for that purpose.

10. *Dismounting.* The instructor halts the carriages as before and commands:

1. *Prepare to Dismount.*
2. DISMOUNT.

At the first command, the cannoneers stand up in their places, except the gunner and No. 5, who face about. At the second command, the whole jump off and run to their posts. When the word DISMOUNT is given by itself the men jump from their boxes in the same manner.

The cannoneers always dismount at the command ACTION FRONT, RIGHT, OR LEFT. They also dismount at the command IN BATTERY, as soon as the carriage on which they are mounted halts.

In horse artillery, the gunner dismounts the cannoneers when the command ACTION FRONT, RIGHT (OR LEFT,) OR IN BATTERY, is given, and all move to their posts at a run, and unlimber as rapidly as possible.

In dismounting or mounting, the cannoneers separate to the right and left of the horse holders, giving the reins to, or receiving the reins from them. The horse holders hold the reins of the horses on their right in the right hand, and the reins of those on the left in the left hand. The horses of the detachment are posted four yards in rear of the limber when the piece is unlimbered for action.

CHANGE OF POSITION OF DETACHMENTS.

11. *To form the order of march*, the detachments being in line in front, the instructor commands :

1. *Detachments to your posts.*
2. MARCH.

At the first command, the gunners face the detachments to the right by commanding, *Right—FACE*. At the second, which is repeated by the gunners, the detachments, Nos. 1 and 2 opening out, file to their posts, each number halting at his place. The gunners face them to the front by commanding, *About—FACE*. To form the order of march, the detachments being in line in rear, or on the right or left, the instructor gives the same commands, but the gunners in each case face the detachments to the left, and march them by that flank to their posts, each number halting as before.

12. *From front to rear.* The instructor commands :

1. *Detachments rear.*
2. MARCH.

At the first command, the gunners face the detachments about. At the second, which is repeated by the gunners, the sections divide, march on each side of their pieces to the rear, unite again, and are halted and faced about by the gunners.

13. *From rear to front, right, or left*, the instructor commands : *Detachments front, right, or left*, MARCH.

In changing from rear to front at the command MARCH, repeated by the gunners, the sections divide, march on each side of their pieces to the front, unite again, and are halted by the gunners.

In changing from rear to right or left, the gunners command: *Right* (or *left*) *oblique* and MARCH successively after the first and second commands of the instructor, and afterwards: *Forward*, MARCH, and HALT, in time to bring the detachments to their posts in line with the limber axletrees.

14. *From the order of March to the rear.* The instructor commands:

1. *Detachments rear.*
2. MARCH.

At the first command, the gunners face the detachments about. At the second, which is repeated by the gunners, the detachments, Nos. 1 and 2 closing to the centre as they advance, march to the rear, file to the left, and are halted and faced to the front by the gunners.

In forming the detachments to the front from the order of march, at the command MARCH, which is repeated by the gunners, the detachments, Nos. 7 and 8 closing to the centre when clear of the horses, march to the front, file to the left, and are halted and faced to the front by the gunners.

In forming the detachments in line to the front or rear, or on the right or left, the gunners dress them to the right after halting them.

The chiefs of pieces, when not mounted, give the commands laid down for the gunners in the foregoing change of positions of detachments.

In horse artillery, to change from front to rear, the gunners command: *Left about wheel*, MARCH;—FORWARD;—*Left about wheel*, MARCH;—HALT.

From rear to front, the gunners command: *Right oblique*, MARCH;—FORWARD;—*Left oblique*, MARCH;—FORWARD;—HALT.

From rear to right (or left,) the gunners command: *Right (or left) oblique, MARCH;—FORWARD;—HALT.*

From right (or left) to rear, the gunners command: *Right (or left) about wheel, MARCH;—FORWARD;—Right (or left) about wheel, MARCH;—HALT.* When the piece is moving the detachments halt or slacken the gait, and afterwards, take their positions in rear by obliquing.

The commands of the instructor are the same as in foot artillery, and are repeated by the officers commanding sections. The commands of the gunners are executed as prescribed in cavalry tactics. The detachments are always dressed to the right by the gunners after they are halted.

SERVICE OF ORDNANCE WITH DETACHMENTS OF DIFFERENT STRENGTHS.

15. Two men. The gunner commands, points, serves the vent, and fires; No. 1 sponges, loads, and serves ammunition.

Three men. The gunner commands, points, serves the vent, and fires; No. 1 sponges; No. 2 loads and serves ammunition.

Four men. The gunner commands and points; No. 1 sponges; No. 2 loads and serves ammunition; No. 3 serves the vent and fires.

Five men. The gunner commands and points; No. 1 sponges; No. 2 loads and serves ammunition; No. 3 serves the vent; No. 4 fires.

Six men. The gunner commands and points; No. 1 sponges; No. 2 loads; No. 3 serves the vent; No. 4 fires; No. 5 serves ammunition.

Seven men. No. 6 attends the limber and serves ammunition to No. 5, and occasionally changes with him. The other numbers as before.

Eight men. No. 7 assists No. 6, and occasionally relieves No. 1. The other numbers as before.

Nine men. No. 8 attends the caisson and supplies the limber with ammunition. The other numbers as before.

The men should be frequently exercised in serving pieces with diminished numbers, that each may know the duties he has to perform in such cases.

Disabled men are replaced by the highest numbers.

Table for the exercise with diminished numbers.

Nos. retained.	Distribution of duties.						
	Gunner	1	2	3	4	5	6 7
G. 1	G. 3, 4	1, 2, 5					
G. 1, 2	G. 3, 4	1	2, 5				
G. 1, 2, 3	G.	1	2, 5	3, 4			
G. 1, 2, 3, 4 . . .	G.	1	2, 5	3	4		
G. 1, 2, 3, 4, 5 . .	G.	1	2	3	4	5	
G. 1, 2, 3, 4, 5, 6 .	G.	1	2	3	4	5	6
G. 1, 2, 3, 4, 5, 6, 7	G.	1	2	3	4	5	6 7

METHOD OF PERFORMING THE DUTIES OF SERVING ORDNANCE.

16. *Commanding and pointing.* The gunner gives all executive commands in action. He is answerable that all the numbers perform their duties correctly. He communicates the orders which he receives for the kind of ammunition to be fired; sending to No. 6 the length of the fuze when firing shells.

On receiving the command or signal to commence firing, he gives the command **LOAD**. And taking hold of the handspike at the end with his right hand and at the centre with his left, and placing his left knee against the left hand, bending over it, the right knee being slightly bent, he looks over the top of the piece and gives the direction. He then steps to the breech to give the elevation, which he does by taking hold of a handle of the elevating screw, drawing back his right

foot and bending over his left knee. When the elevation is given by the quarter sights, the gunner places the nail of his thumb in the proper notch, (See No. 27,) and raises or lowers the breech according to the required elevation. In the drill of recruits the gunner should be made to name the elevation and range before stepping up to the breech. When the piece is loaded and pointed, he gives the command **READY**, and stepping clear of the wheel, to that side where he can best observe the effect of his shot, gives the command *Fire*. As soon as the piece has been fired, he causes it to be run up to its former place, if necessary.

When the instructor instead of giving the command **COMMENCE FIRING**, gives that of **LOAD**, the gunner repeats it and performs the same duties as before, except that he does not command **FIRE**, until the firing is ordered to commence. After the command **COMMENCE FIRING** is given, the action is continued by the gunner without further commands from the instructor, until the firing is ordered to cease. When the commands are all given by the instructor, as in *loading by detail* for the instruction of recruits, the gunner performs the same duties, but without repeating the commands.

17. *Sponging and loading*. Until the command **LOAD**, No. 1 stands square to the front, in line with the front part of the wheels, holding the sponge about the middle of the staff in his right hand, and trailing it at an angle of 45° .

For the convenience of instructing recruits the duties of No. 1 are divided into motions.

1st Motion. At the command **Load**, No. 1 faces to the left, steps obliquely to the right with his right foot, and at the same time brings the sponge smartly to a perpendicular position by drawing his right hand up in line with the elbow. The sponge is grasped firmly in the hand, and the rammer head kept just over the right toe, the elbow close to the side.

2d Motion. He steps obliquely to the left with his left foot, planting it about half way between the piece

and the wheel, and opposite the muzzle, bringing the sponge at the same time across his body to the left, so that his right hand may be opposite the middle of the body.

3d Motion. He takes a side step to the right of thirty inches, and, bending his right knee, brings the sponge to a horizontal position, extending the hands to the ends of the staff, the sponge head to the left, the back of his right hand up and that of his left down; the sponge head against the face of the piece.

4th Motion. He inserts the sponge head, drops his left hand behind his thigh, the shoulders square and feet equally turned out, straightens his right knee, and, bending over his left, forces the sponge home.

18. *1st Motion.* At the command SPONGE, he gives two turns to the sponge, at the same time pressing it against the bottom of the bore.

2d Motion. He draws out the sponge, at the same time straightening his left knee, and bending his right; seizes the staff near the sponge head with his left hand, the back of the hand down, and places the sponge against the face of the piece.

3d Motion. He turns the sponge by bringing his hands together in the middle of the staff, giving it a cant with each hand, throwing the sponge head over, and, at the same time, turning his wrist, which brings the staff horizontal. He then extends his hands to the ends of the staff, the back of the left up, that of the other down.

4th Motion. He introduces the rammer head into the muzzle as soon as No. 2 has inserted the charge, and joins his left hand to his right.

19. *1st Motion.* At the command RAM, he rams home, throwing the weight of his body with the rammer, bending over his left knee, and extending his left arm, back of the hand up in a horizontal position over the piece, and the hand in line with the shoulders.

2d Motion. He jerks the sponge out with his right hand, allowing it to slide through the hand as far as as the middle of the staff, when he grasps it firmly, and,

seizing it close to the rammer head with his left hand, back of the hand up, places the rammer head against the face of the piece, both knees straight.

3d Motion. He then draws the sponge close to his body, and immediately steps back outside the wheel, beginning with his right, then with his left foot; so that when the right foot is brought to it, the right hip may be in a line with the front of the wheel; in drawing the right foot to the left, he gives the sponge a cant with his left hand, at the same time quitting it, and brings the sponge to a perpendicular position in the right, the rammer head resting on the right toe. He remains facing the piece, keeping his eyes fixed on the muzzle, and at the command **LOAD**, steps in and performs his duties in the same manner as before.

When the loading is not by detail, No. 1 goes through all his duties at the command **LOAD**, and returns to his position outside the wheel as given in the 3d motion of **RAM**; and at the flash of the gun steps in and performs his duties in the same manner; this he continues until the command **CEASE FIRING** is given.

At this command, No. 1 steps up between the muzzle and the wheel, by the oblique steps indicated in the exercise above, turns the staff, seizing it with the left hand, at the same time shifting his right, the back of the right up, that of the left down, and passes the sponge on its book, rammer head to the rear for No. 3 to secure; he then steps back as before and faces to the front. If the sponging has been commenced, when the command **CEASE FIRING** is given, it is completed before the sponge is put up.

In sponging and ramming, if the length of the piece requires it, the sponge and rammer are to be pressed home in two motions, No. 1 extending his right hand back to the end of the staff, as soon as it reaches the muzzle.

In sponging *Howitzers*, No. 1 presses the sponge to the bottom of the chamber, which should be well sponged

out. He wipes the bore by rubbing its whole surface without allowing the sponge to turn in his hands.

20. *Loading.* Until the command **LOAD**, No. 2 stands in the same position as No. 1. On this command being given he faces to his right, and by two oblique steps, one to the left, the other to the right, places himself near the muzzle of the piece, and then faces to his right. He brings his hands together to receive the ammunition from No. 5, the cartridge in his right, the shot in his left hand. As soon as the sponge is withdrawn, he faces to his left and puts the ammunition into the muzzle, (taking care that the seam of the cartridge does not come under the vent,) and then steps back, commencing with his left foot, to his position outside of the wheel, in the same manner that No. 1 does. He remains facing the piece until he hears the command **LOAD**, if loading by detail, or observes the flash of the gun if not loading by detail, then steps in and performs his duties as before. At the command **CEASE FIRING**, he takes his position outside of the wheel and faces to the front.

With the *Howitzer* No. 2 puts in the cartridge, which No. 1 sets home; he then puts in the shell so that the fuze may rest against the rammer head, and No. 1 sets it home carefully.

21. *Serving the vent.* No. 3 stands in line with the knob of the cascable, covering No. 1, the priming wire in his right hand, the thumb through the ring. At the command **LOAD**, he steps to his left, wipes the vent field with the ball of his left thumb, then places it on the vent; keeping his elbow raised, and his fingers on the left side of the piece, so as to allow the gunner to point it over his thumb, his right hand on the tube box. When the piece is loaded, he steps to his right at the same time that No. 1 steps back, uncaps a tube or takes a percussion cap, holding it between the thumb and fore finger of his right hand, the hand still on the box, and at the command **READY**, steps in to the piece, pricks the cartridge, drops in the tube or fixes the cap, and remains with his left hand over the vent. At the command **FIRE**,

he steps to his right clear of the wheel. At the command **LOAD**, if loading by detail, or when he sees the flash of the gun, if not loading by detail, he serves vent as before. When a lock is used he draws back the hammer before serving vent. At the command **CEASE FIRING**, he receives the rammer head from No. 1, keys it up, and returns to his position. He also unkeys the sponge in going into action.

22. *Firing.* No. 4 stands in line with the knob of the cascable, covering No. 2. At the command **LOAD**, he steps to his right, takes the portfire stock out of its socket with his right hand, takes hold of the lighted end of the slow match from under the apron of the box, and, blowing it, lights the portfire; he then steps back to his place outside the wheel; holding the portfire stock firmly in the right hand, finger nails to the front, the portfire stock touching the wheel and the portfire inside of it.

When the piece is not provided with a slow match box, the linstock is used. In this case, as soon as the piece is unlimbered, No. 4 steps in and takes the linstock from its socket, steps back again, and plants it in his rear, facing to his right and stepping off with his right foot for that purpose. He then draws back his foot and faces to the front. He lights the portfire by facing and stepping off in the same way.

At the command **FIRE**, he raises his hand slowly, clear of the wheel, turning the back of the hand to the front, brings the portfire rather in front of the vent and fires. As soon as the gun is fired he lowers the portfire slowly. When a lock is used he takes the lanyard in his right hand, moves to the rear so far as to keep the lanyard slack, but capable of being stretched without altering his position, which is to be clear of the wheel. Should the tube or cap fail to explode the charge, the gunner immediately commands, *Dont advance, the tube or cap's failed*; upon which No. 2 steps inside the wheel close to the axletree; No. 3 advances outside the opposite wheel and gives his priming wire to No. 2, who pricks the cartridge; he then gives him a tube or cap which he fixes,

and both resume their posts. No. 4 is answerable that the slow match is kept burning.

At the command **CEASE FIRING**, No. 4 shifts the port-fire stock into his left hand, cuts off the lighted end of the port-fire, and places the stock in its socket; if a lin-stock is used he puts that up also. When using a lock he coils the lanyard round the neck of the cascable, or unhooks it and carries it in his hand, as the mode of attaching it to the lock may require.

23. *Serving Ammunition.* No. 5 stands five yards in rear of and covering the left wheel. At the command **LOAD**, he runs back to No. 6 or No. 7, gets a round of ammunition from him, takes the shot in his right, and the cartridge in his left hand, carries them up and delivers them to No. 2; immediately returns to No. 6 for another round, and then halts at his own post until the piece is fired. At the command **CEASE FIRING**, he carries the round back to No. 6.

With the 12*pd.* *Howitzer*, the ammunition is served in the same way. With the 24*pd.* *Howitzer*, No. 7 carries up the shell on the left side and delivers it to No. 2.

No. 6 attends at the limber and serves ammunition, being careful not to raise the lid unnecessarily. When firing shells he prepares and fixes the fuzes, in which he is assisted by No. 7. At the command **CEASE FIRING**, he secures the lid.

No. 7 supplies ammunition to No. 5 which he gets from No. 6, holding the cartridge in his right, and the shot in his left hand.

24. *Loading by detail.* For the instruction of recruits the exercise is conducted by detail; the instructor giving all the commands. His commands are: *Load by detail*, **LOAD**, 2, 3, 4;—**SPONGE**, 2, 3, 4;—**RAM**, 2, 3;—**READY**;—**FIRE**;—**CEASE FIRING**.

When the men are sufficiently instructed to go through the manual without detail, the commands of the instructor for that purpose, are: **LOAD**;—**COMMENCE FIRING**;—**CEASE FIRING**, or **COMMENCE FIRING** and **CEASE FIRING**. After the command **COMMENCE FIRING**, the

action is continued as laid down for loading without detail, until the command **CEASE FIRING** is given, which is repeated by the chief of the piece and the gunner.

25. *Changing Posts.* In order to instruct the men in all the duties at the piece, the instructor causes them to change posts by commanding, *Change posts—MARCH.* At the command *Change posts*, the men on the right of the piece face about, those that have equipments take them off, and, at the command **MARCH**, each man takes the place and equipments of the one in his front.

No. 1	takes the place of	No. 3
No. 3	of	No. 8
No. 8	of	No. 6
No. 6	of	No. 7
No. 7	of	No. 5
No. 5	of	No. 4
No. 4	of	No. 2
No. 2	of	No. 1

The gunner is changed by the instructor's directing him to change with one of the numbers.

26. *Equipments.* The gunner distributes the equipments at the command **TAKE EQUIPMENTS** from the instructor, he receives them again at the command **REPLACE EQUIPMENTS**, making such disposition of them as may be directed. The portfire case when used is carried by No. 4, hung from his right shoulder to his left side. Ammunition pouches when used are carried by Nos. 5, 7, and 8, hung from the left shoulder to the right side.

POINTING AND RANGES.

27. To point a piece is to place it in such a position, that the shot may reach the object it is intended to strike. To do this, the line of metal, called also the line of sight, which is the straight line passing through the highest points upon the base ring and swell of the muzzle, must

be so directed as to pass through the object; and then the proper elevation must be given to the piece, to throw the shot the required distance. The direction is given from the trail, and the elevation from the breech; the trail being traversed by a handspike, and the breech raised or depressed by an elevating screw.

The notches or sight, which are sometimes made upon the highest points of the base ring and swell of the muzzle, are convenient for aiming a piece when the wheels are upon the same level. When they are not so, these notches must be disregarded; or, if used, as the shot will be thrown below the object, and out of the direction towards the lowest side, an allowance must be made; and that allowance should be increased in proportion to the distance of the object, and the difference of level between the wheels. In this case the piece must be aimed above the object, and to that side which corresponds to the highest wheel.

The elevation is given by quarter sights and tangent scales; the quarter sights being used for elevations less than the dispar, and tangent scales for greater.

Quarter sights are marked upon the upper quarters of the base ring, commencing where it would be intersected by a plane parallel to the axis of the piece, and tangent to the upper surface of the trunnions. These scales are divided into degrees and parts, commencing with zero and extending commonly as far as three degrees. Notches are also made on the swell of the muzzle, commencing where it would be intersected by the same plane.

The tangent scale is a plate of metal, having its lower side so cut as to fit upon the base ring, and the upper cut into notches or steps, and so marked as to show the corresponding degrees of elevation.

Another kind of tangent scale consists of a graduated piece of metal, so placed in a groove or mortise upon the breech, that it may receive a vertical motion, and be fixed at the height required by a thumbscrew. This

scale is not strictly accurate unless the wheels are upon the same level.

By the quarter sights and tangent scales, already described, the various elevations to be given to the axis of the piece above the object may be determined. When great accuracy is required, the line of metal is first directed, so as to pass through the objects, and the elevation given afterwards. But when this is not the case, the first direction required is simply to place the line of metal in the plane of fire, which is the vertical plane passing through the axis of the piece and the object, and the elevation is afterwards increased or diminished as may be required.

The different lines, angles, &c. which are to be taken into account in pointing, will be understood by the following figure.



A B, axis of the piece. B E I F, trajectory, or curve described by the ball. C F, line of sight. C D A, angle of sight, or dispart. The ball being thrown in the direction of the axis A B, is acted upon by the force of gravity, and begins to fall at once below that line at the rate of $16\frac{1}{2}$ feet for one second, $64\frac{1}{3}$ for two, $144\frac{1}{4}$ for three, and so on in proportion to the time. It cuts the line of sight at E, a short distance from the muzzle of the piece, and descending, again cuts it at the point F. This second point of intersection is called the point blank; and its distance from the muzzle the point blank distance. As the natural angle of sight, or dispart, is increased, the ball is thrown further above the line of sight, and the trajectory and point blank distance become more extended. The point blank range increases with the velocity, the diameter, and the density of the ball.

It is also affected by the inclination of the line of sight ; but with the angles of elevation used in field service, this effect is too small to be taken into account.

A piece is said to be aimed point blank when the line of metal, which is the natural line of sight, is directed upon the object. This must be the case when the object is at point blank distance. When at a greater distance the tangent scale is raised upon the breech until the sight is at the height, which the degree of elevation for the distance may require. An artificial line of sight and an artificial point blank are thus obtained, and the piece is aimed point blank as before. When the distance is less than the point blank, and the elevation is to be given by the quarter sights, the piece is first directed in the plane of fire by the line of metal. The thumb nail is then placed in the proper notch, and the breech raised or depressed, until the line passing over the nail and through the notch upon the side of the muzzle, passes on the right or left of the object, and at the same height.

The vertical distances at which degrees upon the quarter sights should be marked above zero, may be found by multiplying the length of the piece, in inches, from the base ring to the swell of the muzzle by .017455. The product gives nearly the length of each degree on the scale.

The same product gives the length of a degree upon the tangent scale, with the same accuracy, and by subtracting the dispart, or half the difference between the diameters at the base ring and swell of the muzzle, the height at which the different degrees should be marked above the base ring may be determined. In field pieces, the dispart being one degree, the second degree is marked upon the scale at the height of one degree above the base ring.

By range is commonly meant the distance between the piece and the object, which the ball is intended to strike.

Point blank range is the distance between the piece and the point blank.

Extreme range is the distance from the piece to the spot where the ball finally rests.

As it is impossible to point a piece correctly without knowing the distance of the object, artillerists should be frequently practised in guessing distances, and measuring them afterwards by pacing, until they acquire the habit of estimating them correctly.

LIMBERING.

28. *To the front.* The instructor commands :

LIMBER TO THE FRONT.

At this command, the piece is brought about by the cannoneers, and the limber, inclining to the right, passes to its place in front of it.

To bring the piece about, the gunner and No. 5, facing towards the left, seize the handspike on the right, (the right and left being that of the *piece unlimbered*,) the gunner near the end and No. 5 at the middle and on his right, raise the trail and carry it round to the left ; Nos. 1 and 2 bear down upon the muzzle, and Nos. 3 and 4, each using both hands, bring the wheels round, No. 3 turning the right wheel to the rear, and No. 4 the left wheel to the front. When the piece is brought about the trail is lowered. Nos. 3 and 4 step within the wheels to avoid the limber ; Nos. 1 and 2 remain at the muzzle, and the gunner and No. 5 step between Nos. 3 and 4 and the trail, the gunner first taking out the handspike and passing it to No. 4, by whom it is put up.

As soon as the limber is in front of the piece, the gunner commands : HALT—LIMBER UP, upon which the limber halts, and the gunner and No. 5 raise the trail by means of the handles, and assisted by Nos. 3 and 4 at the wheels, and Nos. 1 and 2 at the head of the carriage, run the piece forward and place the lunette upon the



pintle. The gunner then puts in the key and all resume their posts. When necessary Nos. 6 and 7 assist at the trail in bringing the piece about and in limbering up.

29. *To the right (or left.)* The instructor commands: **LIMBER TO THE RIGHT (OR LEFT.)** The trail is turned to the right (or left) and the piece limbered up as before, the limber inclining to the right (or left,) and taking its place in front by a right (or left) wheel.

30. *To the rear.* The instructor commands: **LIMBER TO THE REAR.** The limber inclines to the right and takes its place by wheeling about to the left, and the piece is then limbered up as before.

In limbering, when the piece is not drawn by horses, the limber is brought into its position by Nos. 6 and 7, who take hold at the end of the pole for that purpose.

At the command **LIMBER TO THE FRONT**, the caisson closes upon the piece; and at the command **LIMBER TO THE RIGHT (OR LEFT,)** it advances, wheels to the right (or left,) and halts at its proper interval from the piece. In limbering to the rear, the caisson stands fast unless ordered to move.

UNLIMBERING AND COMING INTO ACTION.

31. *To the front.* The instructor commands:

ACTION FRONT.

At this command, the gunner takes out the key, and, assisted by No. 5, raises the trail from the pintle, and then commands **DRIVE ON**, upon which the limber reverses to the left, the horses for that purpose wheeling to the left and rear, in such a manner, as to make the limber pass over the shortest convenient curve; it proceeds to the rear, reverses to the left again, and halts so as to bring the heads of the leading horses six yards from the end of the trail handspike. At the same time that the limber moves off, the piece is brought about in all respects as in limbering to the front, except that the gunner and No. 5

without lowering the trail, carry it about, each by means of the handle on his own side. Nos. 6 and 7, if necessary, assist at the trail.

As soon as the piece is brought about, and the trail lowered, No. 4 takes out the handspike and passes it to the gunner, who fixes it in the trail; No. 1 takes out the sponge, No. 3 unkeying it, and No. 4 takes the linstock, if using one, and plants it in the ground; if using a lock he prepares the lanyard. All then resume their posts.

32. *To the right (or left.)* The instructor commands: **ACTION RIGHT (OR LEFT.)** The piece is unlimbered and placed in the required direction, and the limber wheels to the left (or right) and takes its place in rear by reversing to the left (or right.)

33. *To the rear.* The instructor commands: **IN BATTERY.** At this command, the piece is unlimbered as before, and the limber moves directly to the rear, and takes its place by coming to the left about.

In coming into action, the caisson, at the command **ACTION FRONT**, reverses to the left, proceeds to the rear, and takes its place by reversing to the left again. At the command **ACTION RIGHT (OR LEFT)**, it wheels to the left (or right) and takes its place by reversing.

At the command **IN BATTERY**, it proceeds directly to the rear, and takes its place by coming to the left about.

When the piece is not drawn by horses, Nos. 6 and 7 carry the limber to its proper place.

MOVING THE PIECE BY HAND.

34. *To the front. Piece limbered.* The instructor commands:

1. *Forward.*
2. **MARCH.**

At the first command, Nos. 6 and 7 seize the end of the pole with both hands; the gunner and No. 5, facing towards the pole, seize the splinter bar with one hand,

and the pole with the other; Nos. 3 and 4 seize the spokes of the hind wheels with both hands, and Nos. 1 and 2 apply both hands at the head of the carriage. At the second command, all acting together urge the piece forward.

35. *To the front. Piece unlimbered.* The instructor commands:

1. *By hand to the front.*
2. MARCH.

At the first command, the gunner seizes the end of the handspike, and Nos. 1, 2, 3, and 4 the spokes of the wheels, No. 1 with his left hand, and No. 4 with his right, and Nos. 2 and 3 with both hands. No. 1 holds the sponge in his right hand, the staff resting upon his right shoulder, sponge head down, and No. 4 holds the portfire stock and linstock in his left hand. At the second command, they move the piece forward, the gunner raising the trail.

36. *To the rear. Piece unlimbered.* The instructor commands:

1. *By hand to the rear.*
2. MARCH.

At the first command, the gunner, facing to the rear, seizes the handspike with his right hand. Nos. 1, 2, 3, and 4 seize the wheels as before, except that No. 1, holding the sponge in his left hand, uses his right at the wheel, and No. 4, holding the portfire stock and linstock in his right hand, uses the left at the wheel. At the second command, they move the piece to the rear, the gunner raising the trail.

In moving the piece by hand, all halt and resume their posts at the command HALT.

MOVING AND FIRING WITH THE PROLONGE.

37. The piece being in action, to fix the prolonge to fire in retreat, the instructor commands:

FIX PROLONGE TO FIRE RETIRING.

At this command, the limber inclines to the right, wheels to the left about, and halts four yards from the trail. No. 5 uncoils the prolonge and passes the toggle to the gunner, who fixes it in the trail by passing it upwards through the lunette, whilst he attaches the other end to the limber by passing the ring over the pintle and keying it.

At the command **RETIRE**, the cannoneers face about and all march on the left of the piece, except Nos. 1 and 3. They keep the implements in their hands, and, at the command **HALT**, face about, resume their posts, and go on with the firing.

Should the piece be loaded at the command **RETIRE**, No. 3 puts in the priming wire. At the command **HALT**, he takes it out again, and No. 1 rams home. If the command **LOAD** be given, when the piece is in motion, No. 5 puts in the charge, and No. 2 serves vent, receiving from No. 3 the necessary implements for that purpose.

38. The piece being in action, to fix the prolonge to fire advancing, the instructor commands :

FIX PROLONGE TO FIRE ADVANCING.

At this command, the limber passes its piece on the right and halts when in front of it, Nos. 1 and 3 stepping within the wheels to avoid the limber. No. 5 uncoils the prolonge, carries it to the front, gives the toggle to No. 2, who puts it in the lunette of the axle-strap, whilst he places the ring over the pintle and keys it.

In advancing the men retain their implements and march at their posts. At the command **HALT**, No. 2 takes out the toggle and commands: **DRIVE ON**, upon which the limber takes its place in rear, and the firing is renewed.

When the piece is limbered, to fix the prolonge to fire retiring or advancing, the same commands are

given. The piece is unlimbered, and the prolonge attached as before.

39. To fix the prolonge for passing a ditch, or for any other purpose, the command is **FIX PROLONGE**. The prolonge is then fixed to the trail as before.

In moving with the prolonge, the gunner attends the handspike, and in changes of direction, is careful to circle the trail round in proper time to prevent the prolonge from being cut by the wheels. No. 7 clears the prolonge from the limber wheels, and Nos. 1 and 2 from the gun wheels. In wheeling about the limber first backs a little, and then describes a small circle. In passing a ditch the gunner takes out the handspike.

In fixing the prolonge for any purpose the caisson wheels or reverses, if necessary, so that the horses of the limber and caisson may face in the same direction.

40. To detach the prolonge from the limber and coil it up, the instructor commands :

COIL PROLONGE.

At this command, the gunner takes out the toggle, and No. 5 takes off the ring and coils the prolonge, first passing the ring over the upper prolonge hook.

41. To coil the prolonge and limber to the rear, the instructor commands : **COIL PROLONGE ;—LIMBER TO THE REAR**. The prolonge is detached and coiled as before, the piece is run towards the limber, which reins back on receiving the command **REIN BACK** from the gunner, and is limbered up. To limber to the front, right, or left, the instructor commands : **COIL PROLONGE ;—LIMBER TO THE FRONT, RIGHT, OR LEFT**. Which is executed as already described, the gunner commanding, **DRIVE ON**, as soon as the prolonge is detached.

EXERCISE OF SEVERAL PIECES.

42. For the exercise of several pieces the men are drawn up in line and divided into detachments, each of

which is told off into numbers by the gunner, or chief of piece, who then takes his post on the right. In addition to the instructor, there is an officer assigned to every two detachments, who takes post two paces in front of the centre of his detachments.

The instructor then wheels the detachments into column, or faces them to a flank, either to the right or left; to the right if he is to approach the battery on the left, and to the left if he is to approach it on the right. When in column the gunner, or chief of piece, is two paces in front of the centre of his detachment; when faced to a flank he is by the side of the leading front rank man. In both cases the officers commanding detachments, are two paces from the pivot flank, and opposite the centre of their detachments.

The detachments are then marched to the battery, and when near it the instructor commands: *Detachments opposite your pieces.* Each detachment is halted by the gunner, or chief of piece, when opposite its piece. They are wheeled into line, or faced to the front by the instructor, and then ordered, and marched to their posts by the commands and means laid down in No. 11.

The men are exercised in their duties in the manner already described. The officers carefully superintend them, and see that they perform their duties correctly.

To leave the battery, the detachments are ordered to the front or rear, wheeled into column or faced to a flank, closed to proper distance, and marched from the battery in the manner just described for marching to it.

CHANGING WHEELS.

43. *6pdr. Gun and 12pdr. Howitzer.* The piece being unlimbered, to change the right wheel, the instructor commands:

1. *Prepare to change the right wheel.*
2. **CHANGE THE WHEEL.**

At the first command, Nos. 4, 5, and 6 dismount the spare wheel. No. 5 brings it near, and parallel to the disabled one, leaving room for the latter to be taken off. The gunner passes one end of his handspike to No. 1, placing it under the axletree and close to the shoulder.

At the second command, the carriage is raised; Nos. 2 and 3 take off the disabled wheel, No. 2 runs it to the rear, and Nos. 3 and 5 put on the spare wheel, No. 3 taking hold of it in rear. If necessary one end of a prolonge or drag rope is fastened to the axletree, near the disabled wheel, the other end being passed over the opposite wheel, and manned by Nos. 4 and 6. Nos. 3 and 4 attend to the lincbpins and washers on their respective sides.

To change the left wheel, the gunner and No. 2 man the handspike; Nos. 1 and 4 take off the wheel; Nos. 3, 5, and 6 dismount the spare wheel; No. 5 brings it up, and Nos. 4 and 5 put it on. No. 1 runs the disabled wheel to the rear, and Nos. 3 and 6 act at the prolonge when one is used.

The men at the handspike must raise the end of the axletree sufficiently high to throw the weight on the other wheel, and those who take off the wheel must also lift it, and not increase the weight by allowing it to slide along the axletree.

12pdr. Gun and 24pdr. Howitzer. Four men from another piece must man the prolonge. A spare pole manned by Nos. 1, 2, 3, 4, 5, and 6, must be substituted for the handspike under the axletree. The gunner and No. 7 take off and put on the wheels.

When a spare pole cannot be obtained, the carriage may be raised by means of the handspikes. No. 2 places one in the muzzle and No. 1 crosses the other under it. No. 3 assists at the handspike in the muzzle, and Nos. 4, 5, and 6 at the other, No. 4 on the outside. The four men from the other piece take hold of the cheeks on the side to be raised. All acting together raise the carriage at the command **CHANGE THE WHEEL.** The prolonge is not required. The manoeuvre would

be made easier by digging a trench five or six inches deep for the other wheel.

When a wheel at the piece is disabled in action, it may be replaced by one from its limber. The disabled wheel if not quite unserviceable, may be used at the limber until it can be conveniently changed; but if entirely unserviceable, one must be obtained from the caisson, as soon as it is possible to bring it up.

In taking off a limber wheel the horses are taken out. No. 6 removes the linchpin and washer, Nos. 3 and 4 raise the limber, No. 3 in front and No. 4 in rear of the axletree; Nos. 5 and 6 take off the wheel, and No. 5 runs it forward. The axletree is lowered gently to the ground.

When a wheel has been disabled in the carriage of either piece or caisson, and cannot be replaced by another, a spar ten or twelve feet long may be placed under the axletree, with one end resting on the ground, and the other secured to the carriage by lashing; so that the axletree may be supported in its proper position without the wheel. The part of the carriage thus supported, should be relieved of as much weight as possible.

When a wheel has been so disabled that it cannot turn, a shoe of wood may be made and placed under it. A piece of spar about three feet long and nine inches in diameter, with a groove in one side to receive the felloe, will answer for this purpose. The end in front is given the proper form, and the lock chain fastened to it. In this case also, the carriage should be relieved from as much weight as possible.

DISMOUNTING PIECES.

44. *6pdr. Gun and 12pdr. Howitzer.* The piece being unlimbered, the instructor commands:

1. *Prepare to dismount the piece.*
2. **DISMOUNT THE PIECE.**

At the first command, Nos. 1, 2, 3, and 4 remove the implements and place them on the ground, outside of their respective wheels, the bucket with a sponge and handspike on the right, and the worm with a sponge and handspike on the left. Nos. 1 and 2 then press upon the muzzle, and Nos. 3 and 4, after removing the cap squares, station themselves at the end of the cheeks, and, with one hand on the wheel and the other on the knob of the cascable, prepare to raise the breech. The gunner, first taking out the handspike if in the trail and passing it to No. 4, raises the elevating screw to its greatest height, and then seizes the left trail handle, No. 5 seizes the right, and Nos. 6 and 7 after scotching the wheels, go to the trail to assist in raising it.

At the second command, Nos. 1 and 2 bear down upon the muzzle, the gunner and Nos. 5, 6, and 7, raise the trail until the muzzle rests upon the ground; No. 5, with the howitzer, holding the lock chain to prevent the trail from falling over to the front. Nos. 3 and 4 push against the cascable to raise the breech, and, when the piece is vertical, run round to assist Nos. 1 and 2 to keep it in that position. The trail is then lowered, the carriage run back, and the piece placed on the ground vent upwards. The cannoneers then replace the implements, Nos. 3 and 4 securing the cap squares.

12pdr. Gun and 24pdr. Howitzer. These are dismounted in the same manner, except that Nos. 1 and 2 make a hole in the ground under the head of the carriage, one foot deep for the 12pdr. and eight inches for the Howitzer, to receive the muzzle, and they are assisted by two additional men in pressing upon the muzzle and in steadying the piece.

By attaching the middle of a rope with an artificer's knot to the knob of the cascable, and hauling upon the ends of it, the piece may be more securely steadied. Nos. 3 and 4 attach the rope, pass the ends over to Nos. 1 and 2, and then go round to assist them in hauling upon them. Four additional men from another piece also assist. When the trail is raised so as to let the

muzzle touch the bottom of the hole, the men haul upon the rope and disengage the gun, Nos. 1, 2, 3, and 4 coming up hand over hand to steady it.

A rope may also be used in dismounting the 6pdr. Gun and 12pdr. Howitzer. Nos. 1 and 2 man the rope and Nos. 3 and 4 steady the wheels. No additional men are required.

MOUNTING PIECES.

45. *6pdr. Gun and 12pdr. Howitzer.* The piece being on the ground, vent upwards, the instructor commands :

1. *Prepare to mount the piece.*
2. MOUNT THE PIECE.

At the first command, the implements are removed as in dismounting, except that the handspikes, instead of being placed on the ground, are passed by Nos. 3 and 4, respectively, to the gunner and No. 2; Nos. 3 and 4 take off the cap squares; No. 2 inserts his handspike in the bore, and, assisted by No. 1, raises the chase, so that the gunner may put his handspike under the piece a little in rear of the trunnions. This being done, No. 2 withdraws his handspike from the bore, and places it under the knob of the cascable. Nos. 1, 3, and 4 assist at the handspike of No. 2, and Nos. 5, 6, and 7 at that of the gunner, Nos. 1, 2, 5, and the gunner being at the ends. The gunner then commands: **HEAVE**, upon which the men, acting together, raise the piece upright, and Nos. 1, 2, 3, and 4 steady it in that position. The gunner and No. 5 go to the trail and, assisted by Nos. 6 and 7 at the wheels, run the carriage forward within a foot of the piece. Nos. 6 and 7 scotch the wheels, if necessary, and then go to the trail to assist the gunner and No. 5 in raising it.

At the second command, the trail is raised, No. 5, with the Howitzer, holding the lock chain to prevent

the trail from falling over to the front; Nos. 1 and 2 push gently against the piece and place the trunnions in their plates. The trail is then lowered carefully to the ground, the wheels unscotched and the implements replaced, Nos. 3 and 4 securing the cap squares. When necessary the duties of Nos. 6 and 7 can be performed by Nos. 3 and 4.

The piece may be also easily raised by means of a rope, without the use of handspikes. The gunner fixes the middle of the rope to the knob of the cascable by an artificer's knot, and Nos. 1, 2, 3, 4, 5, and 6 man the ends, Nos. 1 and 2 being nearest the cascable. By hauling upon the rope the piece is raised. It is then mounted as before.

12pdr. Gun and 24pdr. Howitzer. These are mounted by means of handspikes in the same manner as the 6pdr. Gun and 12pdr. Howitzer, except that Nos. 1 and 2 make a hole in the ground, one foot deep for the 12pdr. and eight inches for the Howitzer, to receive the muzzle, and two additional men act at the handles.

It will facilitate the raising of the piece and give greater security, to fasten the handspike to the cascable by means of a rope, and also to fasten, by an artificer's knot, the middle of a prolonge or picket rope to the cascable, and man the ends of it by men from another piece. In this case when the piece is raised as high as the men's hips, the gunner and Nos. 5, 6, and 7 quit the handspike, two at a time, and assist at the prolonge. In placing the piece on the carriage, Nos. 3 and 4 carry the prolonge to the rear, and assist by hauling upon it. When the piece does not fall exactly into the trunnion plates, the prolonge is passed round under the cheeks to secure the breech to the carriage, the trail being then lowered, the trunnions slide into their beds.

CARRYING PIECES.

46. The piece being on the ground, vent upwards, the instructor commands :

1. *Prepare to carry the piece.*
2. *Forward.*
3. MARCH.

At the first command, Nos. 6 and 7 back the limber over the breech until the pintle hook is just above the trunnions; No. 2 inserts a handspike in the bore to raise the piece, and Nos. 1, 3, and 4 stand near to assist him; the gunner, assisted by No. 5, passes the ring of the prolonge through the handles, and after making a turn with the prolonge round the pintle hook, passes the ring through the handles again and puts it on the pintle. If there are no handles, the prolonge should be passed round the piece, in front and rear of the trunnions, the piece being raised for that purpose. Nos. 6 and 7 then raise the pole, and Nos. 1, 2, 3, and 4, the piece, if not already raised; the gunner tightens the prolonge, pulling on the free end, which he passes over the pintle hook, and under the limber to No. 5, who receives it at the splinter bar and makes a turn with it round the fork. The pole is then lowered, and Nos. 1 and 2 press upon the muzzle to raise the breech. The gunner, assisted by No. 5, lashes the knob of the cascable to the splinter bar, fastening the end of the prolonge by half hitches. The piece when slung should be horizontal.

At the second command, the cannoneers prepare to move the limber forward as in No. 34.

At the command MARCH, they move the limber to the front.

When the horses are hitched in, they should be taken out to enable the men to sling the piece.

A limber in addition to carrying the piece, may also carry a disabled carriage, when it is taken apart and lashed upon it, but as the weight when so distributed is too great to be carried far, the carriage should be placed upon the caisson as soon as it can be done.

When a limber is disabled, the trail of the carriage or caisson is attached to the rear of another carriage.

DISMOUNTING CARRIAGES.

47. *Carriage of the 6pdr. Gun and 12pdr. Howitzer.* The piece being dismantled and implements taken off, as already described, the instructor commands :

1. *Prepare to dismantle the carriage.*
2. DISMOUNT THE CARRIAGE.

At the first command, Nos. 3 and 4 remove the lynchpins and washers, and Nos. 1, 2, 3, and 4 step inside the wheels and take hold of the carriage.

At the second command, Nos. 1, 2, 3, and 4 lift the carriage, Nos. 5 and 7 take off the right wheel, and Nos. 6 and 8 the left, Nos. 5 and 6 taking hold in front, and 7 and 8 in rear.

If necessary each wheel may be taken off by one man.

The carriage of the 12pdr. Gun and 24pdr. Howitzer is dismantled in the same manner, with the addition of two or four men to assist in lifting the carriage.

Limbers. The limbers are dismantled in the same manner as the carriages; the different numbers taking hold in the same relative positions and performing the same duties.

MOUNTING CARRIAGES.

48. The method of mounting carriages and limbers corresponds to that of dismantling them.

RIGHTING CARRIAGES THAT HAVE BEEN OVERTURNED.

49. When a carriage has been overturned it is better, if time permit, to disengage the piece, right the carriage, and then mount the piece again in the manner already described. The piece may be easily disengaged by allowing the breech to rest upon the ground, or a block of wood, raising the muzzle by means of a handspike while the cap squares are taken off.

The carriage may be righted, however, without disengaging the piece by the following modes ;

1st. Detach the limber, secure the cap squares, and lash the knob of the cascable to the stock. Place the middle of a rope over the nave of one wheel, pass the ends of it downward between the lower spokes of that wheel, then under the carriage, through the corresponding spokes of the other wheel, and then upwards over the wheel, and across the top of the carriage, to the side where it was first attached. The ends of the rope and the wheel to be raised are then manned, and the carriage drawn over to its upright position. During this operation two men are required to steady the trail.

If necessary the ends of the rope may be fastened to the limber, and horses used to assist in righting the carriage. Great care must be taken to stop the horses in time, and to prevent them from making any more effort than is absolutely necessary. If the wheel horses are sufficient the leaders may be unhitched.

2d. Detach the limber, attach two prolonges, or the middle of a picket rope, to the trail, chock the wheels, and dig an oblong hole under the muzzle about $2\frac{1}{2}$ feet deep. Then pass one of the prolonges, or one end of the picket rope, over the carriage to the front, and, manning both, raise the trail and pass it over the axletree to the ground on the opposite side.

Light carriages may be righted by hand without attaching a rope.

EXERCISE WITH BRICOLES AND DRAG ROPES.

Bricoles or drag ropes are used when pieces are to be moved without horses, and to such distances, or over such ground, that it cannot be done conveniently by hand. Auxiliaries should be used for this purpose, whenever the men required can be obtained. For 6pdr. Guns and 12pdr. Howitzers four auxiliaries, and for 12pdr. Guns and 24pdr. Howitzers eight, are considered sufficient. When there are peculiar difficulties of ground to be overcome, a greater number may be necessary. The numbers assigned to the auxiliaries, are continued upwards from the highest cannoneers.

50. *With bricoles. The piece being limbered.* The cannoneers being at their posts, the auxiliaries are stationed upon each side of the pole, covering each other and one yard apart. All, except the gunner and Nos. 5, 6, 7, 14, and 15, have bricoles hanging over their equipments from the left shoulder to the right side.

To move forward, the instructor commands :

1. *With bricoles forward.*
2. MARCH.

At the first command, Nos. 1 and 2 hook upon the washer hooks of the hind wheels, and Nos. 3 and 4 upon the washer hooks of the fore wheels; No. 5 and the gunner place themselves at the head of the carriage, on each side of the chase; No. 6 detaches a handspike and, assisted by No. 7, fastens it horizontally by the pole chains, across the end of the pole, both placing themselves behind it. Nos. 8 and 9 hook upon the trace hooks; Nos. 10 and 11, with shortened bricoles, upon the hooks of Nos. 1 and 2, and Nos. 12 and 13 upon those of Nos. 3 and 4. Nos. 14 and 15 place themselves by the handspikes, outside of Nos. 6 and 7.

The bricole is hooked and held with the hand nearest the piece.

At the command MARCH, the men move the piece forward.

At the command **HALT**, the men stand fast, keeping their bricoles stretched. At the command **To YOUR POSTS**; all face outwards, and unhooking their bricoles with the hand nearest the piece, resume their posts, No. 6 replacing the handspike.

51. *With bricoles. The piece being unlimbered.* The auxiliaries are at their posts on opposite sides of the pole. To move forward, the instructor commands :

1. *With bricoles to the front.*
2. **MARCH.**

At the first command, Nos. 1 and 2 hook on in front of the axletree, and Nos. 3 and 4 at the wheels. The gunner and No. 5 place themselves at the handspike, the gunner on the left and No. 5 on the right, and Nos. 6 and 7 at the end of the pole. Nos. 8 and 9 double upon Nos. 1 and 2, and Nos. 10 and 11 upon Nos. 3 and 4. Nos. 12 and 13 place themselves at the breech and Nos. 14 and 15 in rear of the limber.

At the second command, the piece is moved forward, the limber following at its proper distance.

The commands, **HALT** and **To YOUR POSTS**, are executed as before.

52. To move to the rear the commands are :

1. *With bricoles to the rear.*
2. **MARCH.**

Nos. 1 and 2 hook on at the wheels, and Nos. 3 and 4 at the trail handles. The gunner and No. 5 go to the handspike, and Nos. 6 and 7 to the pole. Nos. 8 and 9 double upon Nos. 1 and 2, and Nos. 10 and 11 upon 3 and 4. Nos. 12 and 13 place themselves at the head of the carriage, and Nos. 14 and 15 in rear of the limber, which is wheeled about to the left.

At the second command, the piece is moved to the rear, keeping its proper distance from the limber which moves in advance of it.

The commands, **HALT** and **To YOUR POSTS**, are executed as before described; Nos. 6 and 7 wheeling the limber about to the left at the last command.

53. *To support in retreat.* On descending ground the command Nos. 1 and 2, (or 1, 2, 3, 4, &c.) *support in retreat* is sometimes given. The numbers designated, take off their bricoles, hook on and hold back with their hands.

54. *With drag-ropes. The piece being limbered.* The first auxiliaries, Nos. 8 and 9, carry the drag-ropes, the hook end in the hand nearest the piece, the remainder coiled in the other hand. To move forward the commands are: 1. *With drag-ropes forward*; 2. MARCH. Nos. 8 and 9 hook upon the outer trace hooks, turning themselves so as to come inside the drag-ropes. The auxiliaries take hold of the drag-ropes in the order of their numbers, all being inside of them, except the two highest who are at the ends. Nos. 6 and 7 place themselves at the pole, and the gunner and No. 5 at the head of the carriage as in moving with bricoles. The other cannoneers take hold of the drag-ropes in the order of their numbers on the outside. The even numbers man the right drag-rope, and the odd numbers the left. All act together to move the piece forward.

The commands, HALT and To YOUR POSTS, are executed as with bricoles, the drag-rope being unhooked and coiled by Nos. 8 and 9.

55. *With drag-ropes. The piece being unlimbered.* To move forward the commands are: 1. *With drag-ropes to the front*; 2. MARCH. Nos. 8 and 9 hook upon the washer hooks, and the ropes are manned as before. The gunner and No. 5 place themselves at the handspike, Nos. 6 and 7 at the pole, and Nos. 14 and 15 in rear of the limber. The commands, MARCH, HALT, and To YOUR POSTS, are executed as before described.

56. To move to the rear the commands are: 1. *With drag-ropes to the rear*; 2. MARCH. The ropes are attached to the washer hooks as before, but so as to lead to the rear, and the men have the same relative posts. The limber is wheeled to the left about, and all move to

the rear as with bricoles. The commands, **HALT** and **To YOUR POSTS**, are executed as already described, the limber wheeling about at the last command.

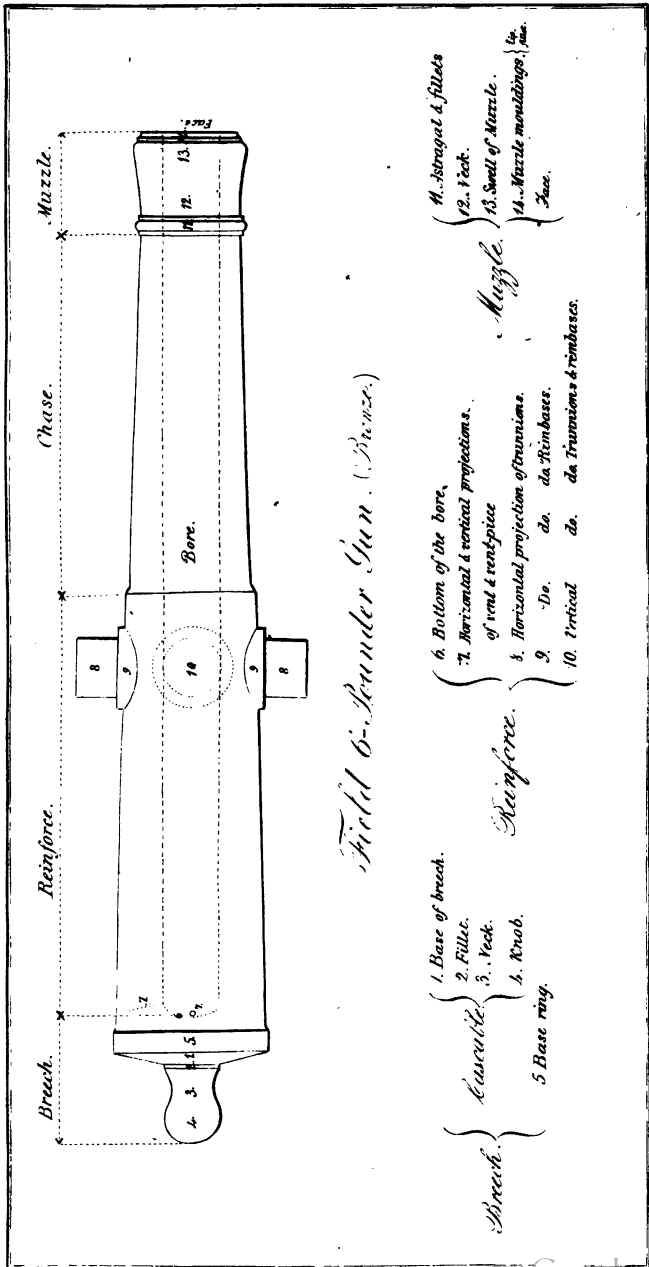

Field 24-Pounder Howitzer (Bronze)

- | | | | |
|--|--|---|---|
| 1. Knob.
2. Neck.
3. Fille ^t .
4. Base of Breech.
5. Base ring. | 6. Vent & vent piece.
7. Chamber.
8. Slope, or conical junction of the cylinder & chamber. | 9. Handles.
10. Trunnions.
11. Rimbases.
12. Chase ring. | 13. Neck.
14. Muzzle band and muzzle fill ^e t.
Note. — Chamber, sloped cylinder. |
| | | | |
| | | | |
| | | | |
| | | | |

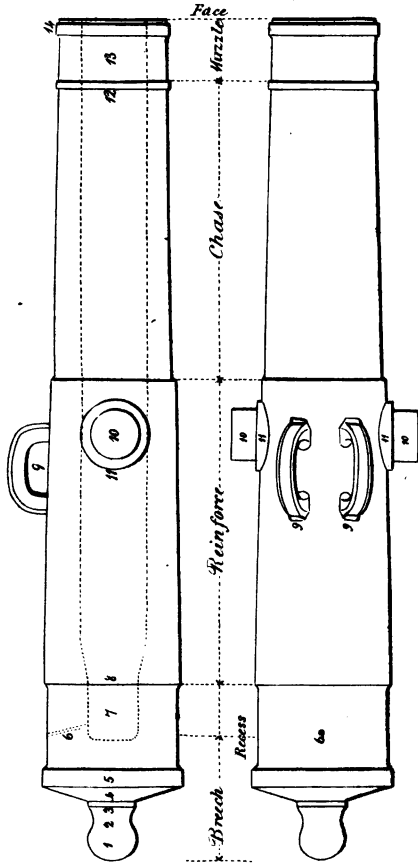

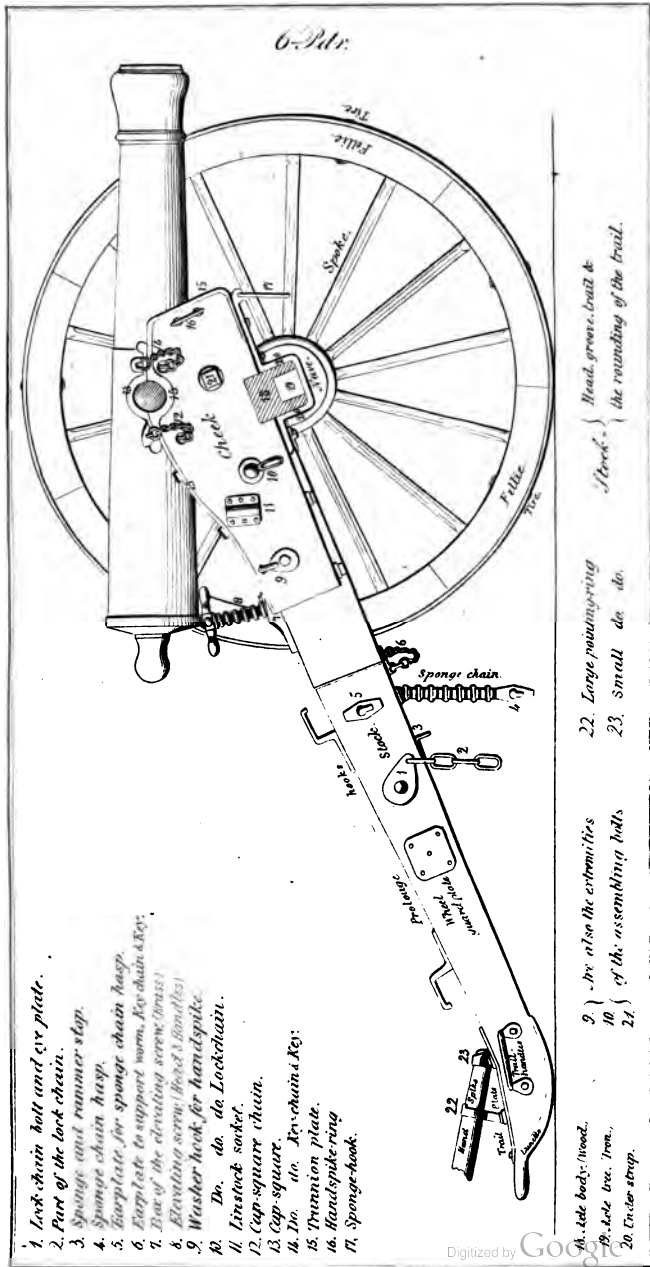

1. Lock chain bolt and eye plate.
2. Part of the lock chain.
3. Spongs and rammer stop.
4. Sponge chain hasp.
5. Trioplate for sponge chain hasp.
6. Eye plate to support worm, Key chain & Key.
7. Disc of the elevating screw (brass)
8. Blatting screw (Wood's Bands)
9. Washer hook for handspike.
10. Do. do. do. Lockchain.
11. Linstock socket.
12. Cap-square.
13. Key chain's Key.
14. Do. do. Key chain's Key.
15. Trunion plate.
16. Handspike-ring.
17. Sponge-hook.

- | | | |
|-------------------------------|-------------------------|--|
| 9. } -br also the extremities | 22. Large pointing-ring | } Head, groove, brail & Stock - the rounding of the trail. |
| 10. } of the assembling bolts | 23. Small do. do. | |
| 24. } | | |
| 18. Lute body (wood). | | |
| 19. Lute box (iron). | | |
| 20. Under strap. | | |

*Projection of 6-Pitz carriage on a plane
parallel to the under-side of the stock, (mounted.)*

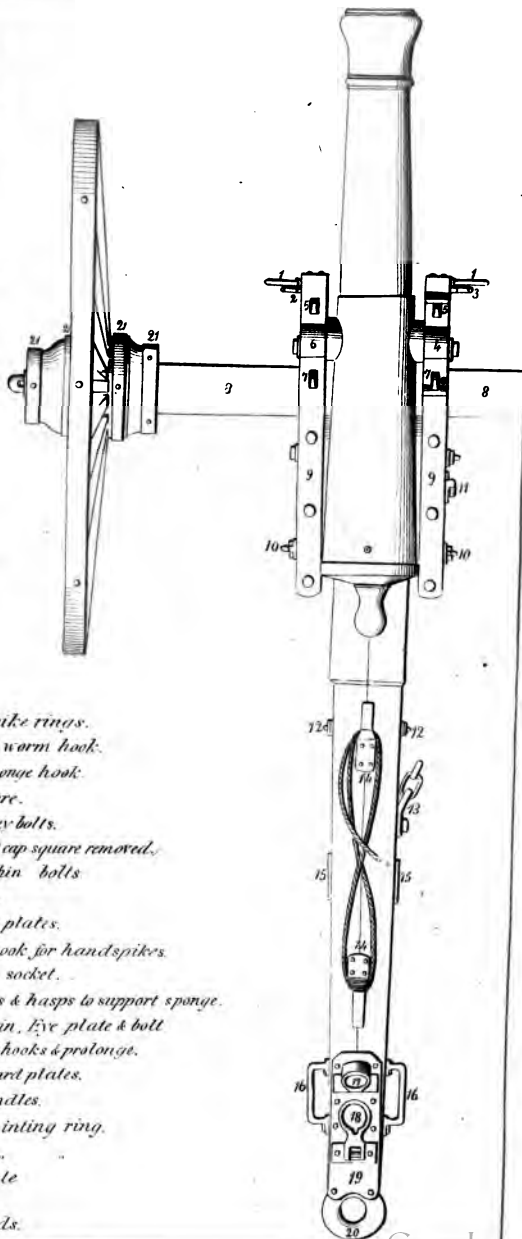

1. Hand spike rings.
2. Sponge & worm hook.
3. Right sponge hook.
4. Cap square.
5. Head of key bolts.
6. Trunnion (cap square removed).
7. Head of chin bolts.
8. Axle body.
9. Trunnion plates.
10. Washer hook for handspikes.
11. Linstock socket.
12. Eye plates & hasps to support sponge.
13. Lock chain, Eye plate & bolt.
14. Protonge hooks & protonge.
15. Wheel quart plates.
16. Trail handles.
17. Small pointing ring.
18. Large. " "
19. Trail plate.
20. Lunette.
21. Nave bands.

- | | | | | |
|----------------------|-------------------------------|-----------------------------------|------------------|-----------------------------------|
| 1. Handles. | 7. Back strap. | 13. Pole-prop chain. | 19. Axle-body: | The shoulder washers, Linch-pins, |
| 2. Ammunition Chest. | 8. Front do. | 14. Pole-prop (socket & ferrule.) | 20. Axle-tree. | Linch washers & Wheels, are the |
| 3. Cover or lid. | 9. Stay-pins, Keys, &c. | 15. Splinter-bar: | 21. Under Strap. | same as for the gun carriage. |
| 4. Corner plates. | 10. Stay for Amm. Chest. | 16. Foot boards. | 22. Pintle hook. | 25. Pole yoke. |
| 5. Turnbuckle. | 11. End bands of splinter-bar | 17. Foot board brackets. | 23. Pole. | 26. Pole chains. |
| 6. Hasp. | 12. Trace Hooks | 18. Hounds. | 24. Prolonge. | |

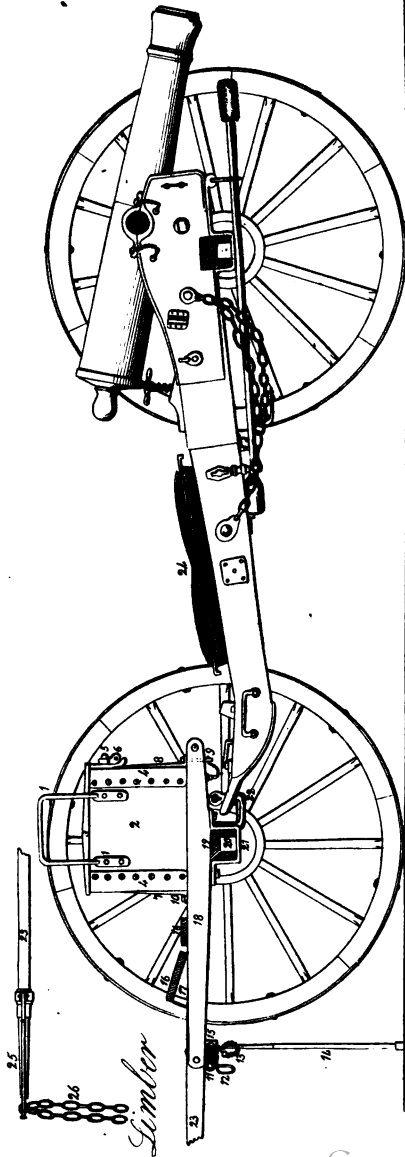

- 1. Pole,
- 2. End bands of splinter-bar and trace hooks,
- 3. Middle bands of splinter-bar and trace hooks,
- 4. Splinter bar.
- 5. Hounds,
- 6. Fork,
- 7. Fork strap,
- 8. Foot boards,
- 9. Ammunition chest,
- 10. Handles of ammⁿ chest,
- 11. Pull-hook,
- 12. Pull-hook key,
- 13. Buff and collar of Pole yoke,
- 14. Branches of do do
- 15. Stading rings,
- 16. Pole strap.

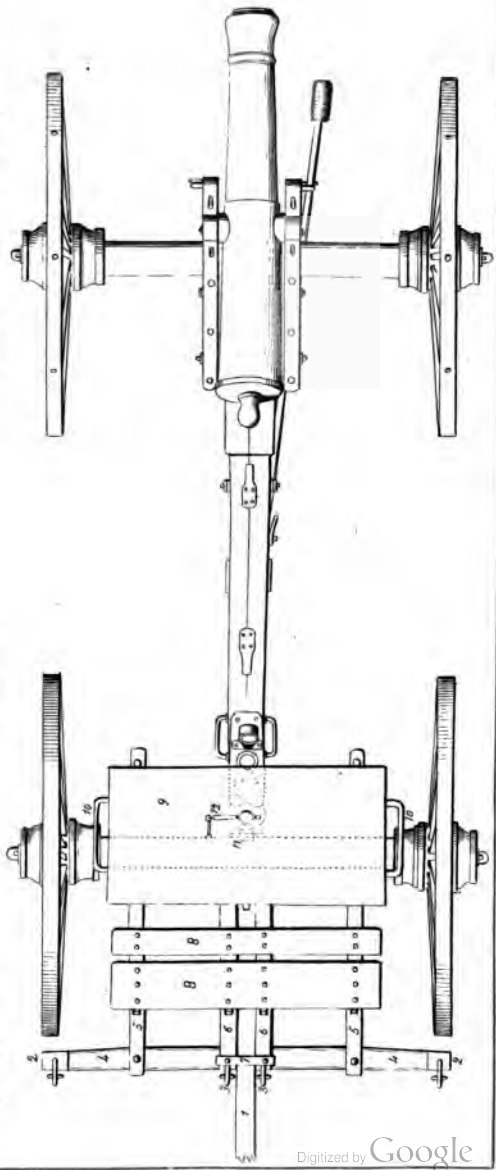
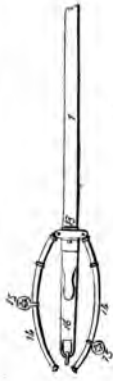

Battery Wagon.

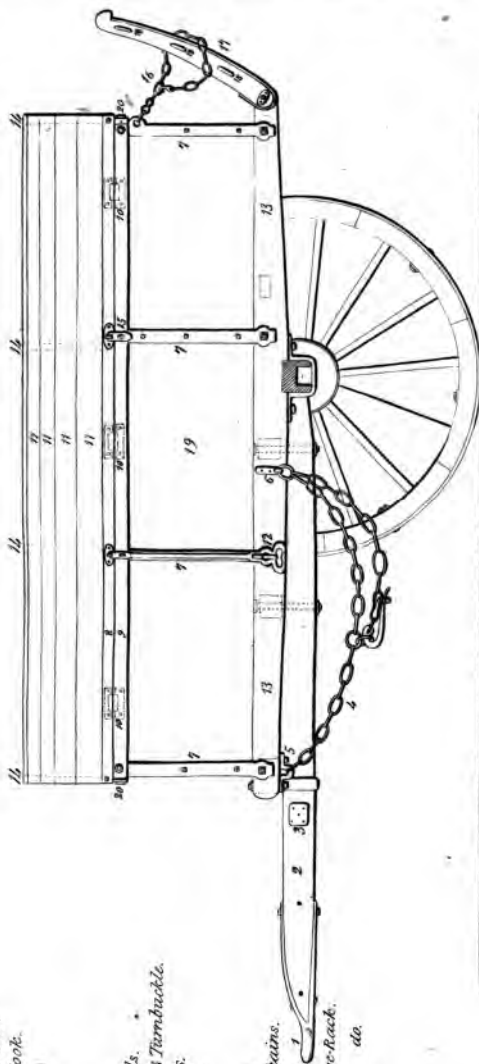

1. Lunette.
2. Stock.
3. Guard plate.
4. Lock chain.
5. do. Bridle.
6. do. Hook.
7. Studs (iron.)
8. Side rails.
9. Upper do.
10. Hinges.
11. Cover boards.
12. Cover strap & Turnbuckle.
13. Bottom rails.
14. Haws (Iron.)
15. Hasp.
- Forage Rack.
16. do. do. chains.
17. Sides of Forage Rack.
18. Bars of do. do.
19. Side Boards.
20. Side Stays.

Buttery Wagon.

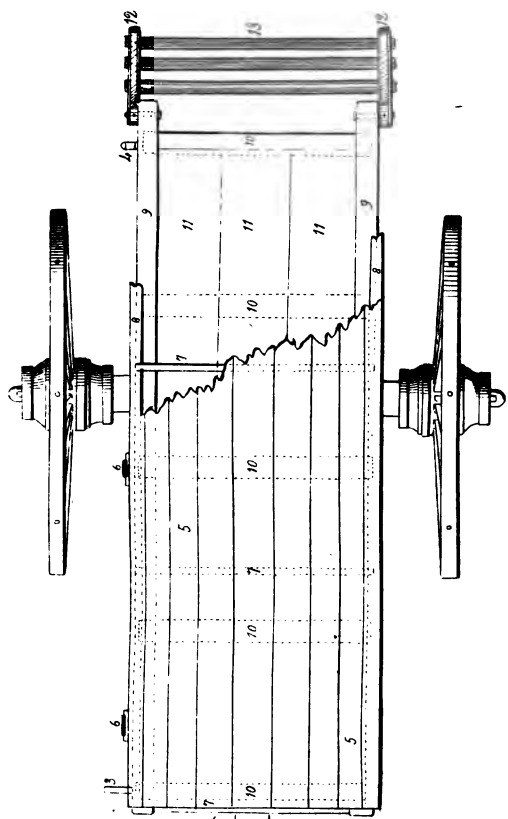

- 1. Lunette.
 - 2. Stock.
 - 3. Spare stock stirrup to carry a spare
 - 4. do. do. Hook. } iron braced stock.
 - 5. Cover boards.
 - 6. Hinges.
 - 7. Bows.
 - 8. Side rails.
 - 9. Bottom rails
 - 10. Cross bars.
 - 11. Bottom boards.
 - 12. Sides of Forage rack.
 - 13. Bars of do.
- Wheels same as those for gun carriage.*



Travelling Forge.

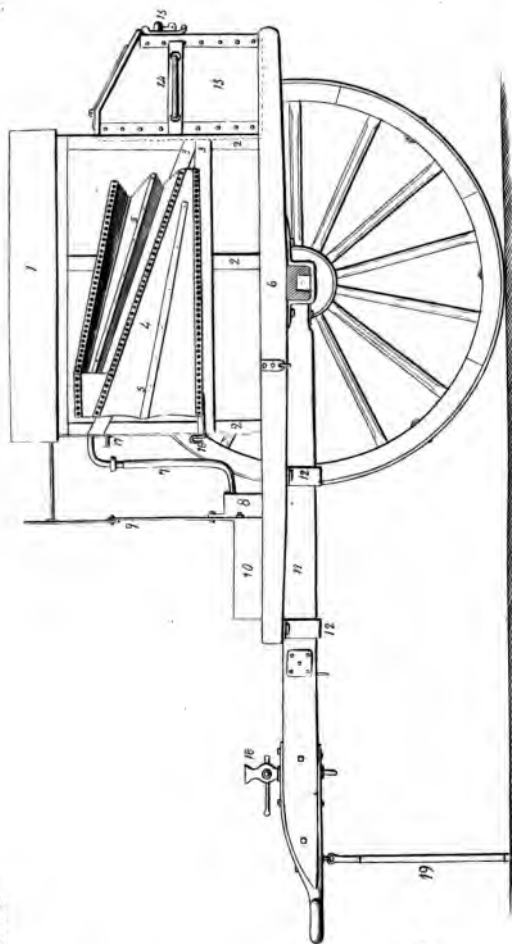

1. Roof of the bellows house.
2. Studs.
3. Cinders to support bellows.
4. Bellows.
5. Ribs of do.
6. Side rail.
7. Windpipe.
8. Air back.
9. Back of fire place.
10. Fire place.
11. Stock.
12. Stock stirrups.
13. Coal box.
14. Handles.
15. Trumbside.
& Hasp.
16. Bellows Hook.
17. Fulcrum, & support
for Bellows pole.
18. Vice.
19. Trop.

Travelling Forge.

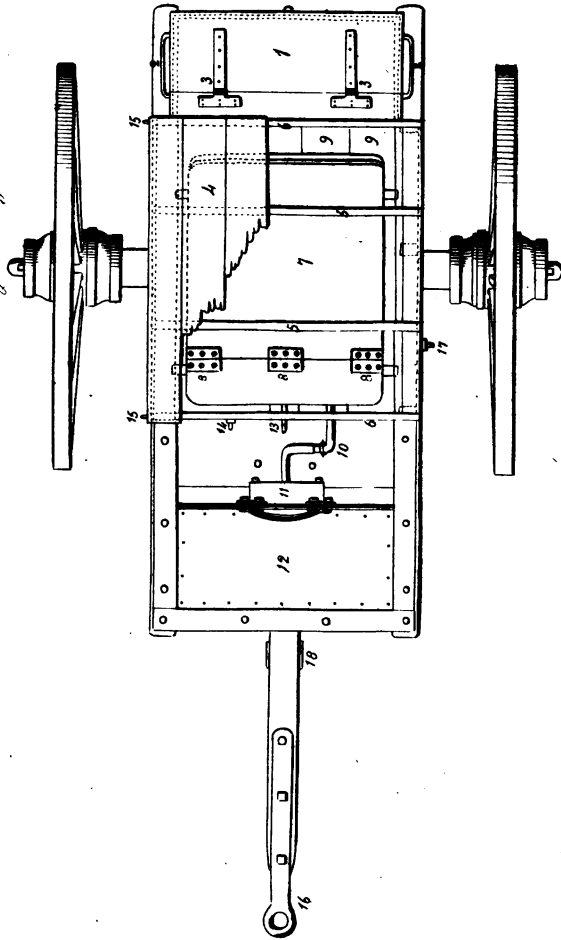

1. Lid of the coal box.
2. Handles of do.
3. Hinges of do.
4. Roof Boards.
5. Bows.
6. End boards.
7. Bellows.
8. Hinges.
9. Bottom Boards.
10. Windpipe.
11. Air duct.
12. Bellows hook.
13. Fulcrum.
14. Hook & staple for carrying bellows pole.
15. Lunette.
16. Lock chain hook.
17. Mail guard plates.
- 18.

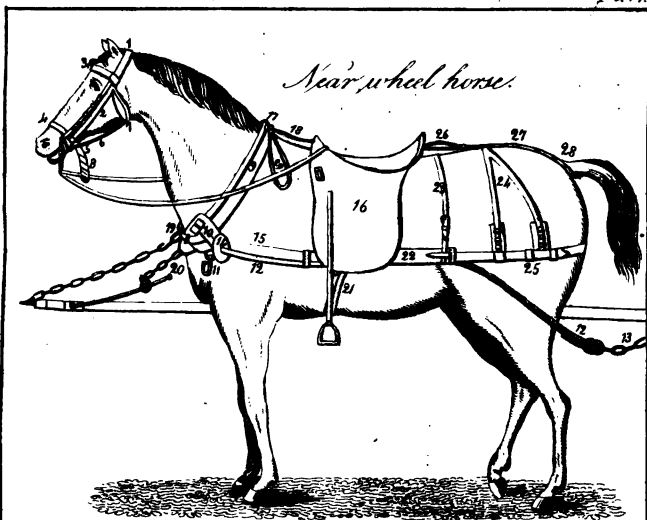

Near wheel horse.

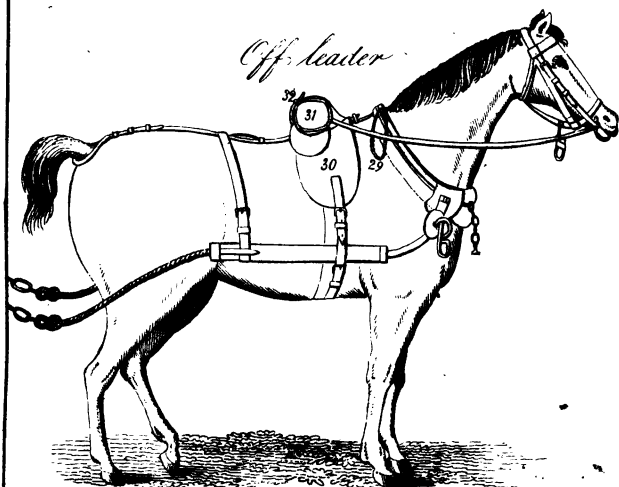

Off leader.

- | | | |
|--|---|---|
| <p><i>Halter:</i>
 1. Crown piece.
 2. Cheek strap.
 3. Brow band.
 4. Nose band.
 5. Chin strap.
 6. Throat strap.
 7. Throat lash.
 8. Hitching strap.</p> | <p><i>Bridle:</i>
 Crown piece.
 Cheek strap.
 Brow band.
 Throat lash.
 Bit.
 Reins.</p> | <p><i>Bit:</i> curb (consisting of bar with a portmouth,) cheek pieces, and curb chain).— 9. Collar & Hames, with joint loops for trace tugs. 10. Trace tugs & saddle. 11. Trace hook.— 12. Trace rope.— 13. Trace chain.— 14. Saddle. 15. Breast strap.— 16. Saddle.— 17. Hame strap. 18. Collar strap.— 19. Sliding loop & pole chain hook 20. Chain & toggle.— 21. Girth.— 22. Side pipes 23. Loin strap.— 24. Hip strap.— 25. Breech strap. 26. Back strap.— 27. The body.— 28. The dock.)
 29. Trussing strap.— 30. Valise saddle.— 31. Valise. 32. Valise straps.</p> |
|--|---|---|

SCHOOL OF THE DRIVER.

PART FIRST.

METHOD OF INSTRUCTION.

INSTRUCTION in horsemanship should be given according to the *Cavalry tactics*; reference must therefore be made to that book for the necessary information on this head.

All the cannoneers should be taught to ride, that they may be capable of acting as drivers; and in *horse artillery* they should receive the same elementary instruction in all respects as cavalry soldiers, so far as it is applicable to their arm.

Not more than eight men with their horses are united for instruction in the first part. The men have their spurs and sabres; and the horses are harnessed.

LEADING THE HORSES TO THE EXERCISE GROUND AND COUPLING.

57. The drivers, with sabres hooked, form in one rank four yards apart, each with his horses on his right. In leading the horses to the exercise ground, the driver conforms to the rules prescribed in cavalry tactics, except that in addition, he holds the coupling rein of his off horse, thrown over the neck of his near, in his right hand, and in this way leads both. On reaching the exercise ground he unhooks his sabre. The instructor then commands:

COUPLE.

58. At this command, the driver goes in front of his horses, faces towards them, passes his right hand through the reins of his near horse, and doubles the coupling rein three feet and a half from the bit; with his right hand he passes this doubled part, from below, through the ring on the right hame of the near horse, inserts the running end of the coupling rein through this loop, makes it fast by pulling with his left hand, and then resumes the position of *stand to horse*. When the off horse has a curb bridle, the rein of this bridle is held in the hand without being coupled.

TO MOUNT.

59. The instructor commands :

1. *Prepare to mount.*
2. MOUNT.

These commands are executed as prescribed in cavalry tactics. The reins being adjusted, the driver seizes the whip with his right hand and fastens it to his wrist by means of the loop, and then takes hold of the coupling rein twenty inches from the hame, closing his hand and pressing his thumb strongly against the second joint of his forefinger, the nails downward and the arm falling naturally.

USE OF THE COUPLING REIN AND WHIP.

60. The coupling rein and whip are for the off horse what the bridle reins and legs are for the near. If the off horse moves too far forward, he is gently checked by carrying the right hand with the rein nearer to his neck; if he keeps behind, make him feel the whip on his right haunch; if he throws his shoulders in or haunches out, touch him gently with the whip on his right haunch. The driver should be careful not to use the coupling rein abruptly, especially in halting and reining back;

School of the driver

Fig. 1.

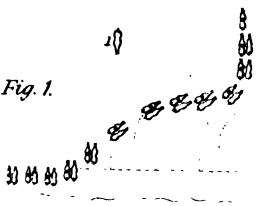

Fig. 2.

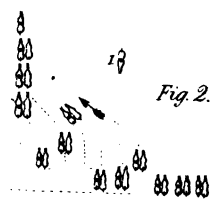

Fig. 4.

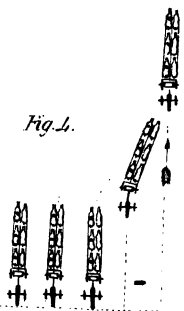

Fig. 3.

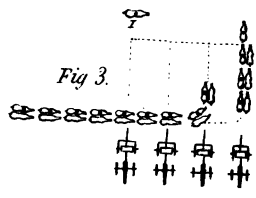

Fig. 5.

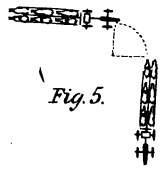

Fig. 9.

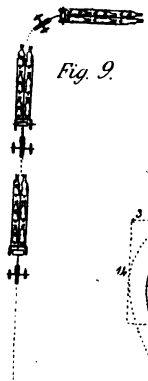

Fig. 8.

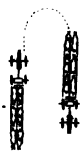

Fig. 6.

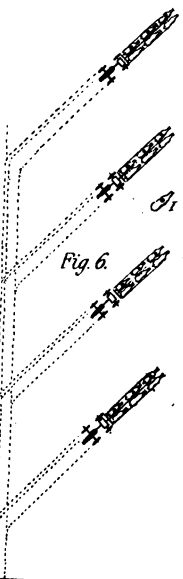
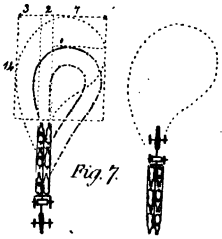

Fig. 7.



otherwise, he will throw the horse suddenly and too much upon his haunches.

61. *In gathering the horses*, the driver raises his right hand and moves it towards the neck of the off horse; at the same time executing for his near horse what is prescribed in cavalry tactics.

62. (Pl. 12, fig. 1.) *To break by pairs from the right*, the instructor commands: 1. *By pairs from the right, front into column*; 2. MARCH. This will be executed as prescribed in cavalry tactics, the driver starting his off horse by lowering his right hand and moving it forward, replacing the hand as soon as the horse obeys.

63. *To halt*, the instructor commands:

1. *Column.* 2. HALT.

The driver halts the near horse as prescribed in cavalry tactics, and the off horse by gradually raising his right hand and moving it towards the neck of the horse.

TO WHEEL TO THE LEFT FROM A HALT.

64. The instructor commands:

1. *Left into line wheel.*
2. MARCH.
3. HALT.

At the first command, gather the horses. At the second, wheel them to the left, making the near horse describe a quadrant (five yards) of a circle whose radius is 3.25, and quickening the gait of the off one.

At the third command, halt and hold the horses straight.

Wheeling to the right from a halt, is executed in the same manner and by inverse means.

THE ABOUT.

65. This is executed according to the same principles as the wheel; the inner horse describing a semi-circle of ten yards, and the outer horse one of twelve.

THE OBLIQUE.

66. This is executed according to the principles of the wheel, observing that the oblique is but the fourth of a circle.

TO REIN BACK.

67. The instructor commands :

1. *Backward.*
2. MARCH.
3. HALT.

The principles are the same as for halting, observing to lower and raise the wrist alternately as the horses obey.

At the command Halt, slacken the reins and close the legs; when the horses obey replace the hands and legs.

TO MARCH TO THE FRONT AND TO A FLANK.

68. *To the front when in line.* The instructor commands: 1. *Forward*; 2. MARCH; 3. *Guide right* (or *left*.) The drivers move their horses forward as already prescribed, and preserve their intervals of four yards.

69. *To a flank when marching in line.* The commands are: 1. *By the right* (or *left*) *flank*; 2. MARCH; 3. FORWARD. Each driver wheels his horses as already described and moves forward.

70. *To the front when in column.* The commands are: 1. *Column forward*; 2. MARCH.

71. *To a flank when in column.* The commands are: 1. *Column*; *by the right* (or *left*) *flank*; 2. MARCH; 3. FORWARD; 4. *Guide left* (or *right*.) The drivers wheel their horses, march forward, and keep their intervals as before.

72. When marching in line, the commands for halting are: 1. *Drivers*; 2. HALT. When in column they are: 1. *Column*; 2. HALT.

TO DISMOUNT.

73. The instructor commands :

1. *Prepare to dismount.*
2. DISMOUNT.

At the first command, the driver lets go the coupling rein, and fixes the whip in the ring of the left hame of the near horse ; he executes the remainder as in cavalry tactics, except that he hooks up his sabre as soon as he dismounts.

TO FILE OFF.

74. The instructor commands :

1. *By the right (or left) file off.*
2. MARCH.

These commands are executed as in cavalry tactics, except that the driver uncouples, holds the coupling rein, and leads his off horse as in marching to the exercise ground.

SCHOOL OF THE DRIVER.

PART SECOND.

METHOD OF INSTRUCTION.

IN giving instruction in the second part not more than twelve drivers should at first be united ; but as soon as they are sufficiently instructed, the number may be increased to twenty-four.

The instructor is mounted and aided by two assistants, who are also mounted.

ARRANGEMENT OF THE TEAMS.

75. The drivers, dismounted, are in one rank, each preserving an interval of two feet between his off horse and the near horse of the man on his right. The leading horses are on the right, and the wheel horses on the left in each team; this rule is invariable.

When the pieces are parked in more than one line, the teams of the second line are placed, each on the left of the corresponding team in the first; the teams of the third line are placed in like manner on the left of the teams of the second, and so on; the teams of the same file of carriages being always drawn up in the same line, from the right to the left.

The teams may be drawn up in two or more lines if the nature of the ground requires it.

The drivers couple their horses without command, and the instructor, after aligning them, causes them to mount as prescribed and commands:

1. *Right-Dress.*
2. *FRONT.*

The drivers align themselves, each preserving an interval of two feet between his off horse and the near horse of the driver on his right.

TO BREAK INTO COLUMN.

76. The instructor commands:

1. *By team from the right—front into column.*
2. *MARCH.*

(Pl. 12, fig. 1.) At the command *MARCH*, the leading driver and all the others, successively, execute the movement explained in No. 62, each driver regulating the obliquity of his march according to his distance from the right.

TO ENTER THE PARK.

77. The instructor directs the column towards the

left of the park ; and when the head of the column is near the left carriage, he commands :

1. *Teams to your posts.*
2. MARCH.

(Pl. 12, fig. 3.) At the command MARCH, the column takes such a direction as will lead it in front of, and near the poles of the carriages, and parallel to the line of the park ; each team when within three yards of its carriage, changes its direction to the left and halts.

If there are several lines of carriages, the teams of the second break off from those of the first at the command MARCH, and form a column, which executes with reference to the second line a similar movement to that just described ; the teams of the third line execute for that line what has been prescribed for the second, &c.

78. When the instructor is compelled to enter the park by its right, the teams are broken from the left by the commands, 1. *By team from the left—front into column* ; 2. MARCH. At the command MARCH, (pl. 12, fig. 2.) the leading driver of the left team moves to the front and is followed by the other drivers of this team, who break successively as has been prescribed ; the leading driver of the second team from the left commences his movement in time to get his proper distance in the column, and is followed in succession by the other drivers of this team ; and so on to the right, the drivers regulating the obliquity of their march by their distance from the left flank.

To enter the park, the column is directed towards its right, and the movement is executed according to the principles explained for entering by the left, and by inverse means.

HITCHING IN.

79. The instructor having caused the drivers to dismount, as prescribed, commands :

HITCH.

At this command, each driver goes in front of his horses, faces towards them, and seizes with his right hand the reins of his near horse, and with his left the coupling rein of his off horse near the left ring of the bridle. The wheel driver backs his horses so that they may be easily hitched; opens the branches of the pole yoke; fixes the toggles to the sliding rings, commencing with his off horse; and fastens the pole chains to the sliding loops of the breast straps, commencing with his near horse. He then goes in rear of his off horse, passing by the right, detaches his traces and hitches them to the splinter bar, commencing with the inner one; passes in a run around the carriage, raises and fastens the pole prop; detaches the traces of his near horse and hitches them, terminating with the outer trace, and then resumes his position of *stand to horse*.

The middle driver as soon as the pole chains are hooked, backs his horses, moves behind his off horse, passing by the right, detaches the traces, and, when the off wheel horse is hitched, fastens them, commencing with the outer trace, being careful to put the inner trace above the pole chains. He finishes by hitching the outer trace of the near horse, and resumes the position of *stand to horse*. The leading driver regulates himself by the middle driver, conforming to what has been prescribed for that driver.

The instructor carefully examines whether the traces are equal, and well stretched, and of the proper length; whether the leathers are on the flat side and the breeching well placed, &c; and finally, passing from one part to another, causes whatever is wrong to be corrected.

TO UNPARK.

80. After the teams are hitched, the instructor causes the drivers to mount and and commands:

1. *By piece from the right—front into column.*
2. MARCH.

(Pl. 12, fig. 4.) At the first command, the drivers gather their horses.

At the second command, the carriages of the right file move straight to the front, and are followed by those of the file next on the left, the leading one of which, commencing to move when the hind wheels of the rear carriage of the right file are opposite its leaders, obliques to the right and takes its place in column in rear of that file; it is followed by the other carriages of its file, which march directly in its track.

This movement is executed successively by the other files, the leading carriage of each increasing the obliquity of its march in proportion to its distance from the right flank. The carriages preserve in column the distance of two yards from each other.

When the pieces are parked in one line, the movement is executed in the same way, each carriage moving when the hind wheels of the one on its right are opposite its leaders.

Unparking from the left is executed according to the same principles and by inverse means.

Before a carriage moves the traces should be equally stretched, so that at the command MARCH, the horses may pull steadily and together. This precaution prevents those jerks which fatigue the horses and frequently break the harness.

TO HALT.

81. When the carriages are accurately placed in column, the instructor commands:

1. *Column.*
2. HALT.

At the first command, the drivers gather their horses without slackening the gait. At the second, they halt according to the principles of No. 63. The wheel drivers must exert more strength in halting than the other drivers, as their horses have to act against the im-

pulsive force of the carriage. When the carriages are halted, the traces must be stretched by carefully moving the horses a step or two forward.

EXERCISE AT A HALT.

82. The instructor commands :

1. *Left into line wheel.*
2. MARCH. 3. HALT.

(Pl. 12, fig. 5.) At the first command, the drivers gather their horses. At the second, the leading drivers execute a left wheel according to the principles of No. 64; the other drivers wheel successively on the same ground and in the same manner.

The command HALT is given the moment the carriages are fully in the new direction.

In the wheelings, and in the movements which depend on them, the leading driver enters the new direction without making his horses pull, the middle driver does the same, and it is not until the wheel driver is in the new direction that the traces are stretched. This principle is not rigorously applicable on difficult ground.

83. *Wheeling to the right* is executed according to the same principles and by inverse means.

84. (Pl. 12, fig. 6.) *Obliquing to the left or right* is executed at the commands, 1. *Left (or right) oblique*; 2. MARCH; 3. HALT; according to the principles prescribed for wheeling, observing that the leading horses only describe the eighth of a circle, and then move direct to the front.

THE ABOUT.

85. To establish the carriages in the opposite direction and on the same ground, the instructor commands :

1. *Pieces left about.*
2. MARCH. 3. HALT.

(Pl. 12, fig. 7.) At the command **MARCH**, the drivers oblique the horses to the right; and the leading driver, after moving seven yards in that direction, reins his horses to the left in such a manner that the extreme part of the curve they describe shall be fourteen yards from their point of departure, and that, after passing three yards to the left of the original line of direction, they shall return to the ground on which the carriage first stood. The other drivers direct their horses so that the limber wheels shall describe a loop, which, extending seven yards to the right and eleven to the front of the position occupied by the leaders before starting, shall pass a little to the left of the line of direction, and return in such a manner that the hind wheels, without crossing that direction, shall be brought to the position from which the leaders started.

The command **HALT** is given, as soon as the leading horses reach the ground, on which the hind wheels stood at the commencement of the movement.

In order that the preceding movement may be better understood, the instructor causes the carriages to execute it in succession. In each instance he precedes on foot the leading horses, and passes over the curve which they are to describe.

TO REVERSE.

86. (Pl. 12, fig. 8.) To establish the carriages in the opposite direction, but not on the same ground, the instructor commands:

1. *Pieces right (or left) reverse.*
2. **MARCH.** 3. **HALT.**

At the command **MARCH**, the drivers wheel the horses at once to the right (or left) and rear, so as to bring the carriage about by causing it to describe the shortest curve its construction will permit.

The command **HALT** is given when the carriage is straight in the opposite direction.

TO REIN BACK.

87. The instructor commands:

1. *Pieces backward.*
2. MARCH. 3. HALT.

These commands will be executed according to the principles of No. 67. The wheel driver must exert more strength in reining back than the other drivers. If the carriage does not back straight, incline the pole from that side towards which the carriage is gaining ground. At the command HALT, the drivers cease to back and stretch the traces.

TO REIN BACK TO THE RIGHT.

88. The instructor commands :

1. *Pieces to the right and backward.*
2. MARCH. 3. HALT.

At the first command, the drivers direct the poles to the right without advancing or backing the carriage. At the second, they rein the horses back as prescribed in No. 67, taking care to keep them to the right.

At the command HALT, they place the team and carriage in line and halt, stretching the traces.

Backing to the left is effected according to the same principles and by inverse means.

The instructor directs the drivers to make the off wheel horses back a little sooner than the others.

Whenever carriages have to execute an about in a narrow space, as a street for instance, this mode of backing is necessary. In this case the drivers, after obliquing to the right (or left) until within four yards of the wall, back to the right (or left) until the hind part of the carriage touches the wall, and then execute a *reverse*.

TO MARCH AND TO HALT.

89. To put a column in motion the instructor commands :

1. *Column, forward* ; 2. MARCH, and to halt it, he commands : 1. *Column* ; 2. HALT.

TO CHANGE DIRECTION ON A MARCH.

90. To change the direction of the column to the right, the instructor commands :

Head of column to the right.

(Pl. 12, fig. 9.) At this command, the assistant instructor commands: 1. *Right wheel*; 2. MARCH; 3. FORWARD.

The drivers of the leading carriage execute the wheel as before prescribed and, at the command FORWARD, march direct to the front. The drivers of the other carriages wheel them successively to the right on the same ground, precisely, as that on which the first carriage wheeled.

91. To wheel all the carriages at the same time to the right in order to march in line, or to form line, the instructor commands: 1. *Column by the right flank*; 2. MARCH; 3. FORWARD; 4. *Guide left*. The drivers of each piece wheel to the right at the second command, and at the third, move direct to the front.

TO EXECUTE THE ABOUT WHEN MARCHING IN COLUMN.

92. The instructor commands: 1. *Pieces left about*; 2. *March*; 3. FORWARD. The drivers of each piece execute the about as prescribed in No. 85, and without halting move forward at the third command.

The drivers of the last carriage which is to become the head of the column, must be careful to execute the about without slackening the gait, in order not to delay the other carriages.

This movement is performed at a walk, and the instructor, without requiring all the carriages to come about at the same time, must carefully observe and correct, if necessary, the means employed by the drivers for executing it.

TO REST.

93. The instructor wheels the pieces into line, halts them, dismounts the drivers, and commands: REST. The drivers remain near their horses.

94. To resume the exercise, the instructor wheels the pieces into column by commanding, 1. *By the right (or left) flank*; 2. MARCH; 3. FORWARD.

During the rest, the instructor sees that the drivers arrange every part of their harness which may have been displaced during the drill. He should occasionally question the drivers, to ascertain whether they understand the principles they have been applying.

In executing the various movements when in march, the instructor will see that the drivers apply the principles prescribed for the same movements at a halt.

TO PASS FROM THE WALK TO A TROT AND THE REVERSE.

95. The instructor's commands are: *Trot*—MARCH, and *Walk*—MARCH; which are executed as prescribed in cavalry tactics, observing for the off horse the principles of Nos. 62 and 63.

TO PASS SUCCESSIVELY FROM THE REAR TO THE HEAD OF THE COLUMN.

96. To prepare the drivers for the passage of carriages in the school of the battery, the instructor frequently causes the rear carriages to pass to the head of the column. To execute this movement he commands:

1. — *Carriage pass to the head of column.*
2. MARCH.

At the command MARCH, the designated carriage obliques to the right until entirely without the column, and then moves forward in the original direction, marching parallel to and near the column, until opposite the leading carriage, when it takes its place at the head of the column by first inclining to the left, and then moving to the front.

When the column is at a halt, the piece executes the passage at a walk, and when it is marching at a walk, the passage is executed at a trot; as soon as the piece arrives at its position, it halts or walks according as the column is at a halt or in march.

The instructor also causes other carriages, besides the rear one, to pass to the front. He may either close the vacant spaces or leave them open. To close them, he

directs the rear carriages to quicken the gait, but not to change it.

FROM A HALT TO MARCH AT A TROT, AND THE REVERSE.

97. The instructor commands :

1. *Column, forward.* 2. TROT. 3. MARCH.

At the second command, the drivers gather their horses, and at the third, start them off together.

98. *Marching at a trot to halt*, the instructor commands : 1. *Column* ; 2. HALT. The drivers halt their horses quickly but not suddenly ; a carriage moving at a trot cannot be halted instantaneously, but must advance five or six yards after the command HALT.

TO PASS FROM THE TROT TO THE TROT OUT.

99. The instructor commands : TROT OUT. To resume the ordinary trot he commands : SLOW TROT. These commands are executed as prescribed in cavalry tactics.

TO DISMOUNT WHILST MARCHING.

100. The horses marching quietly, and the distance being well observed, the instructor commands : (*such*) *driver*—DISMOUNT.

The driver designated lets the reins slip on his horse's neck, and dismounts without abandoning his whip, observing to plant his right foot as far as possible in advance of the horse's shoulder ; he quickly disengages his left foot from the stirrup, and moving opposite the near horse's head, seizes the left rein with his right hand.

TO MOUNT WHILST MARCHING.

101. The instructor commands : (*such*) *driver*—MOUNT. The driver designated lets go the rein, faces to the right about, places his left hand on the head of the collar, seizes the stirrup with his right hand, and quickly inserts his left foot ; he then rests his right hand on the cantle, raises his right leg and, passing it over the croup, places himself lightly in the saddle.

To avoid accident, the instructor first practices the men in executing these movements at a halt, not exacting that all shall dismount or mount at the same time.

TO PARK.

The instructor directs the column towards the park and gives, according to the position of the ground on which the pieces are to be parked, one of the following commands :

1. *At—yards interval.* { *Forward into park—right (or left) oblique.*
 { *To the right (or left) into park.*
 { *On the right (or left) into park.*
2. MARCH.

102. *To form forward into park.* The column approaches the park from the rear, the leading piece being in rear of the ground on which it is to rest.

At the command MARCH, the leading piece marches direct to the front and halts, on the caution of the assistant instructor, at its proper place; all the other carriages oblique to the right (or left) until near their places in park; when they change direction to the front so as to come up square on the line. They halt a little in rear of the line and dress forward on the carriage already established.

103. *To form to the right into park.* The instructor, approaching the park by its right, directs the column parallel to the front and forty yards behind it. At the command MARCH, which is given when the leading piece is three yards from the point opposite the position which it is to occupy, the assistant instructor wheels it to the right, moves it forward, and halts it at its position. The other carriages move straight forward; each one wheels to the right when three yards from the point opposite to the position it is to occupy in park, marches forward, and places itself on the right of and in line with those already established.

To form to the left into park is executed according to the same principles and by inverse means.

104. *To form on the right into park.* The instructor, approaching the park by its right, directs the column parallel to the front and forty yards in rear.

The leading piece is wheeled to the right and established in its position as before ; the next, passing in rear of it, places itself in line on its left in like manner, and so with the others.

When the park consists of two or more lines, the same principles are observed ; each carriage of the rear ranks follows its file leader in its movements.

The park should be formed on the left according to the same principles and by inverse means.

TO UNHITCH.

105. The park being formed, the instructor causes the drivers to dismount as prescribed and commands :

UNHITCH.

The leading driver goes in front of his horses, faces towards them and backs them in order to unhitch them more easily ; then, passing by the left of his near horse, unhitches his traces, commencing with the outer one, bends them, and fastens them by means of the trussing straps. He unhitches the off horse in the same manner, commencing however with the inner trace ; and having finished, he passes by the rear of his horses and resumes the position of *stand to horse*.

The middle driver unhitches, conforming to what has been prescribed for the leading driver.

The wheel driver goes to the splinter bar, lets down the pole prop, unhitches, bends, and fastens the traces of the near horse ; passes at a run around the carriage, unhitches and fastens the traces of the off horses ; then goes in front of his horses, and, commencing with the near horse, unhooks the pole chains ; detaches the toggles from the sliding rings, commencing with the off horse ; unites the branches of the pole yoke and resumes the position of *stand to horse*.

The instructor mounts the drivers as has been prescribed.

TO LEAVE THE PARK.

106. The instructor commands :

1. *By team, from the right, front into column.*
2. MARCH.

At the second command, the right team marches to the front until it is disengaged from the pole, and then changes head of column to the right or left as the instructor may direct; it will be followed by the other teams, which execute their movements so as to have their proper distances in the column.

The instructor marches the troop to the parade ground and forms it into line, the drivers preserving the prescribed interval (No. 75.) He then causes the men to dismount and to *file off*.

When the instructor is obliged to leave the park from the left, the movement is executed according to the same principles and by inverse means.

SCHOOL OF THE BATTERY.

GENERAL REMARKS.

THE manœuvres of infantry, cavalry, and artillery are regulated by the same general principles; but as the infantry constitutes the main body of an army, its movements necessarily control those of the other arms. In this work the infantry forms of command have been adopted for the artillery as far as the difference between the two services would permit.

A battery executes nearly the same manœuvres as a battalion of infantry, but with less precision. For its elements cannot be moved with the same accuracy as platoons of well instructed infantry. In some respects the exercises prescribed for field batteries, exceed those required for the purposes of war. But they should be regarded as a study which it is advantageous to extend beyond its ordinary applications; so that the most difficult circumstances may not present any thing that is unknown, or that may lead to the commission of serious errors.

No rules are laid down for the application of field battery manœuvres to the evolutions of troops of different arms. Although all arms are governed by the same general principles, each has an appropriate code for its own manœuvres, which is not extended to the general movements of other troops. The best, and perhaps the only way, for an artillery officer to manage his battery properly, when manœuvring with other troops, is to understand the infantry and cavalry manœuvres; so that he may at once comprehend the command of the general officer and determine the position which the artillery should take. No rules can be laid down for conducting batteries to the positions they are to occupy; for the

order, gait, and direction of each battery, are modified by the configuration of the ground to be passed over, as well as by the march of the infantry and cavalry. The artillery, without being obliged to follow step by step all the manœuvres of the infantry and cavalry, proceeds to the execution of its orders in the easiest and most expeditious manner. The proper employment of this arm, according to the situation of the ground and the circumstances of the case, must ever be kept in view in all orders issued to it.

No other division is made in the battery of manœuvre but that of sections; each being composed of two pieces and two caissons. The column of sections is not only found to be sufficient for the purposes of manœuvre, but much more convenient than the column of pieces or half batteries. The column of pieces requires too great an extension of the battery and too much time for its evolutions. In the column of half batteries one chief of section is deprived of his command; and, when formed at full distance, the depth of the column is essentially the same as in that of sections. Moreover, when this column is used for manœuvre, the pieces of the same section cannot be kept long together in any part of the battery.

Each piece and its caisson are kept in a fixed relation to each other, and may be said to constitute a unit. They are separated only in the formations in battery. This principle simplifies the manœuvres greatly, and renders it generally unnecessary to give separate commands to the caissons.

No notice is taken of inversions in any of the orders, either in column, in line, or in battery. The most simple and rapid formations are always adopted.

The passage of carriages is used as an elementary principle in the manœuvres. In the formations in battery it is indispensable for changing the front of a line. And when executed seasonably, as a preparatory movement, it greatly facilitates all the formations. It may be executed with the same, or an increased gait.

But one wheel is admitted. The pivot carriage preserves its gait, while the others regulate theirs according

to their distances from it; the guide being always on the pivot flank.

No general or special guides are used. The chiefs of pieces, and in horse artillery the chiefs of caissons also, are the guides of the carriages to which they are attached. And each becomes the guide of the line or column whenever his carriage occupies the position to which the movements are referred.

The cautionary command *ATTENTION* is not embraced among those required for the manoeuvres, but may be used at the discretion of the captain. The commands of the chiefs of sections are more numerous, and those of the captain are more frequently repeated, than in other arms of service, on account of the noise of carriages and extent of command.

As a general rule the cannoneers should mount the ammunition chests only for rapid movements; and when within range of the enemy's guns they should dismount, unless important considerations require a continuation of the rapid gait. The explosion of a caisson when the cannoneers are mounted might destroy many men.

The three orders, in column, in line, and in battery, are so established as to occupy the least possible space, and to require the least ground for their formations. In both kinds of artillery, whether in column or in line, the distance between two carriages, or between a carriage and detachment, is two yards. The interval is so calculated that the column may be readily formed into line. The intervals thus resulting are different in the two kinds of artillery; but when they manoeuvre together, the carriages of foot artillery take the intervals and distances belonging to those of horse artillery.

In the order in battery the distances are the same for both kinds of artillery. This order presents an arrangement which the exigencies of war habitually vary. But the rule requiring the limbers and caissons to face towards the enemy, should be departed from only while firing in retreat.

In that formation in battery which requires the caisson and detachment of horse cannoneers to pass the piece, the detachment does not pass until after the caisson; and

the cannoneers do not dismount until the detachment has reached its place in battery. The first part of this arrangement arises from the fact, that the passage of the caissons is a preparatory step, which should be completed before the command **IN BATTERY** is given. The second part is intended to avoid the difficulty, which would be experienced by the horse holders in leading their horses, and the inconvenience and danger of halting near the piece, and thus grouping all the horses together at the moment of coming into battery.

Two methods have been adopted for the formations in battery to the front; one requiring the pieces to be thrown forward; the other requiring the caissons to be thrown to the rear. The first method is equally adapted to light and heavy batteries. By this method the pieces and caissons are rapidly separated; and the commands may be given while the battery is moving, so as to leave the caissons at their proper distance in rear of the line on which the pieces are to form. The second method is not adapted to heavy batteries, on account of the difficulty of turning the pieces about by hand. But with light pieces it is advantageous when the battery is already formed upon the line of battle; or when the head of a column which is to be formed into battery is very near that line. In horse artillery the first method of coming into action is considered the best. For, while the cannoneers are dismounting, the pieces are moved forward and wheeled about by the horses; so that nothing remains for the cannoneers but to unlimber and commence firing. Moreover, when the command for this formation is given, the detachments halt at once on the ground which their horses are to occupy in battery.

Explanation of the signs in the plates.

	Original Position.	Intermediate Position.	Final Position.
<i>Piece drawn by six horses.</i>			
<i>Caisson drawn by six horses.</i>			
<i>Limber drawn by six horses.</i>			
<i>Piece in battery with its hand spike.</i>			
<i>Platoon of horses in charge of the horse holders.</i>			
<i>Platoon of cannoners</i>	<i>Horse Artillery:</i>		
	<i>Foot Artillery:</i>		
<i>Captain comman^d the battery:</i>			
<i>Lieut comman^d a section.</i>			
<i>Chief of the line of caissons.</i>			
<i>Chief of piece, horse artillery.</i>			
<i>Chief of piece, foot artillery.</i>			
<i>Chief of caisson horse artillery.</i>			
<i>Chief of caisson foot artillery.</i>			
<i>Horse not mounted</i>	<i>Chief of piece.</i>		
	<i>Chief of caisson.</i>		
<i>Cannoner at his post.</i>			
<i>Bugler or trumpeter.</i>			
<i>Chief of piece dismounted and at his post.</i>	<i>horse or foot</i>		
	<i>artillery:</i>		

----- Indicates the front of a line of carriages or of a detachment in an original, intermediate, or final position, or in a change of direction.

..... Indicates an intermediate position.

The direction in which the plates should be seen

Scale of yards.

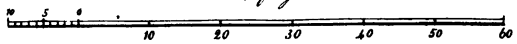

MANŒUVRES OF A FIELD BATTERY.

THE manœuvres of a field battery are intended to furnish the instruction required for conducting its movements and formations, in all situations in which it can be employed. These manœuvres are taught to the non-commissioned officers theoretically and practically. The theoretical instruction should embrace every thing under the head of general remarks. The practical instruction should commence with the most simple movements, executed at a walk, and as the instruction advances the gait should be increased. Each movement should be repeated until it is fully understood, and executed without hesitation, by all who co-operate in its performance.

The text applies especially to batteries whose cannoneers are not mounted; but it becomes equally applicable to horse artillery, by inserting the proper intervals and distances with the detachments of mounted cannoneers. (See the orders in column, in line, and in battery.)

When the detachments of mounted cannoneers are required to make any particular movements, directions will be given for them. But in general, as they have only to follow two yards in rear of the muzzles of their pieces, they will not be mentioned.

The movements are described for one flank only. They may be executed by the other flank, according to the same principles and by inverse means.

**COMPOSITION OF THE BATTERY OF
MANŒUVRE.**

107. The battery of manœuvre is composed of six field guns, or four guns and two howitzers, six caissons, and the officers and men required for their service.

Each carriage is drawn by four or six horses; and the officers and men are as follows:

One captain who commands the battery.

Four lieutenants; the first in rank commanding the right section, the second the left, the third the centre, and the fourth the line of caissons. When half batteries are formed the first commands the right, and the second the left.

Six mounted non-commissioned officers; each charged with guiding and superintending a piece.

Six detachments of cannoneers; each containing nine men in foot and eleven in horse artillery, including the chief of the caisson, and the gunner who has charge of the detachment. In each detachment of horse artillery two of the cannoneers are horse holders.

One trumpeter or bugler.

108. The battery is divided into three sections, denominated the right, left, and centre sections; each containing two pieces and two caissons. In each section the pieces are denominated right piece and left piece.

The battery is also divided into half batteries, denominated right and left half batteries.

109. The word *piece* applies to the gun or howitzer, either with or without its limber; and sometimes to the piece and caisson together.

110. The *front of a battery*, in the order in battery, is the front of the line of pieces. In all other formations it is the front of the first line of drivers.

111. The *right or left* of a battery is always that of the actual front, whether the pieces or caissons lead.

112. The *interval* is a space measured parallel to the front.

113. The *distance* is a space measured in depth, or perpendicular to the front.

114. The *measures of intervals and distances* are given in yards, and express the vacant spaces between the component parts of the battery.

115. (Pl. 14.) The object of a *right or left wheel* is to give the carriage a direction perpendicular to the one it had before. In executing it the leading horse on the pivot flank, describes a quadrant (5 yards) of a circle

Passage of Carriage.

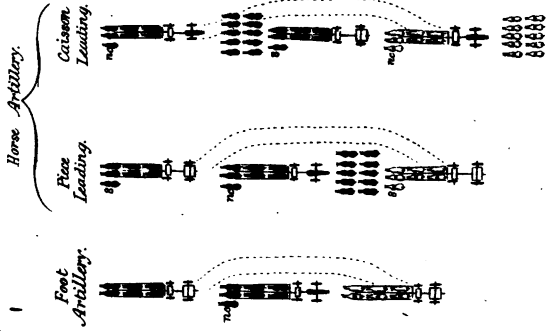

Wheel of a section.

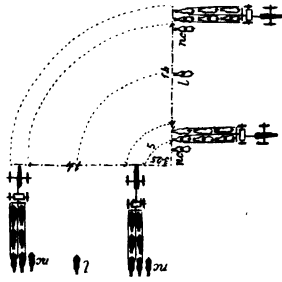

Left wheel.

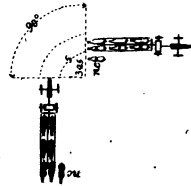

Left oblique.

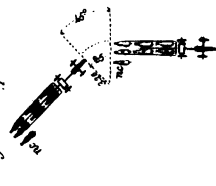

Countermarch.

Left about.

Foot Artillery.

Horse Artillery.

Foot Artillery.

Horse Artillery.

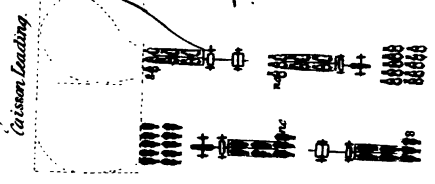
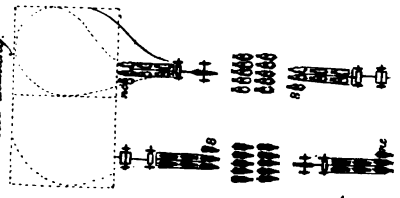
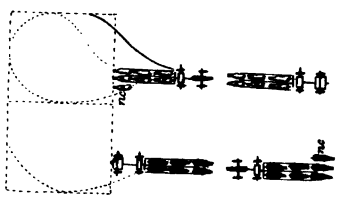
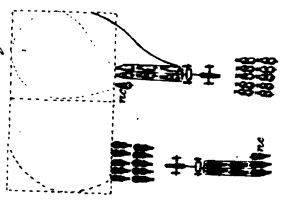
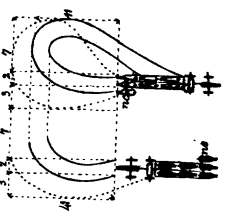

Note. The tracks of the timber wheels are indicated by full lines, the track of the off leader by broken lines.

whose radius is three yards and a quarter, and then resumes the direct march. The horse coupled to him increases his gait and conforms to his movement, resuming the direct march at the same time. The centre and wheel horses follow in the tracks of their leaders.

116. (Pl. 14.) The object of a *right* or *left oblique* is to give the carriage a direction inclined 45° to the right or left of the one it had before. In executing it the leading horse on the pivot flank describes the eighth of a circle whose radius is 3.25 yards, and then resumes the direct march. The horse coupled to him increases his gait, conforms to his movement, and resumes the direct march at the same time. The other horses follow in the tracks of their leaders. The oblique of a carriage is in fact one half of a right or left wheel.

117. (Pl. 14.) The *passage* applies to two carriages in file; and its object is to pass the rear carriage to the front. To execute it the rear carriage inclines to the right, passes the one in front, and takes its proper distance in front by inclining to the left. The reciprocal gaits of the carriages are regulated by commands.

118. (Pl. 15.) The object of an *about* is to establish the carriage on the same ground, but in the opposite direction; having the heads of the leading horses where the hinder part of the carriage was before. For the easy execution of this movement at all gaits, and with a carriage of four wheels, all the horses incline at once to the right as they advance, and so move, according to their distances from the pole, as not to interfere with the wheel horses which really govern the carriage. (See No. 85.)

In *horse artillery* the detachment of connoneers follows the piece, which advances seven yards after finishing the about, in order that the heads of the leading horses may reach the position occupied by the rear of the detachment.

119. (Pl. 15.) The *countermarch* applies to two carriages of different kinds in file. Its object is to make them both perform the about and to establish them on

the ground they occupied before, but in the opposite direction and with the same carriage in front. In performing it the carriage of the front rank executes an about at once, and moves to the place which was occupied by the other carriage. The latter follows the track of the former, executes the about on the same ground, and takes its place.

120. There is but one kind of wheel, which is that with a moving pivot. The carriage on the pivot flank wheels in such a manner as to unmask the ground where the movement commenced. When the wheel is made with a section front, the pivot carriage describes a quadrant (5 yards) of a circle whose radius is 3.25. With a battery front, the pivot carriage describes a quadrant (22 yards) of a circle whose radius is 14. If the wheel be ordered from a halt, the pivot carriage moves at a walk; if on the march it preserves its gait. In all cases the marching wing regulates its gait in such a manner as to remain the shortest possible time in rear of the line, without urging the horses unnecessarily. In all wheels the guide is on the pivot flank, and the intervals are preserved from that flank.

In *foot artillery* the chiefs of pieces act as guides, marching for that purpose with the leading carriages.

In *horse artillery* they are also guides, except when the caissons lead and their chiefs are mounted; these chiefs becoming the guides in that case. The guide of the battery is that of the carriage to which the movements are referred.

121. The *alignment* is made on the drivers of the wheel horses, except in battery, when it is made on the hind wheels.

122. In giving commands the strength of voice should be proportioned to the length of the line. When a chief of section does not hear the commands, he regulates his movement by what he sees executed by an adjoining chief. The command ATTENTION is given by the captain at the commencement and at each renewal of the exercise; but afterwards it is given only when he thinks it necessary to fix attention.

Order in Column:

Foot Artillery.

Horse Artillery.



123. Trumpet or bugle calls are used instead of commands whenever they can be advantageously introduced. The calls in use will be found in a table in their appropriate place.

POSTS OF THE CANNONEERS DURING THE MANŒUVRES.

124. During the manœuvres the cannoneers in foot artillery are either in files on both sides of their pieces, or mounted on the ammunition chests. In horse artillery they are in detachments of two ranks, and habitually in rear of their pieces. The detachments in horse artillery may be ordered to the right or left for greater convenience in making a rapid movement; or for coming into battery to the rear, when the caissons are in front. But as their positions on the flanks are inconvenient for manœuvre, they should be ordered to the rear as soon as the special object has been accomplished. Their proper places in rear should be always kept open for that purpose.

FORMATIONS OF THE BATTERY.

The three following orders constitute the different formations of the battery of manœuvre.

1. ORDER IN COLUMN.
2. ORDER IN LINE.
3. ORDER IN BATTERY.

125. (Pl. 16.) The *order in column* is that in which the battery is formed by sections; the carriages being in two files, and each piece being followed or preceded by its caisson.

The captain is generally 14 yards from the column and opposite to its centre. But during the manœuvres he moves wherever his presence may be most necessary, and where his commands may be best heard.

Each chief of section is in line with his leading drivers, and midway between his leading carriages.

The chief of the line of caissons is in line with the captain, on the same side of the column, and 4 yards

from it. But he does not change his position to conform to that of the captain.

Each chief of piece is on the left and near the leading driver of his leading carriage. In horse artillery, when the chiefs of caissons are mounted, each chief of carriage is near its leading driver on the left.

The trumpeter is near the captain.

In foot artillery.

The interval between the carriages is 14 yards. The distance between the carriages is 2 yards. The cannoners are in file on each side of their pieces, or mounted on the chests.

In horse artillery.

The interval between the carriages is 17 yards. The distance between the carriages, and between the carriages and detachments, is 2 yards.

The detachments, formed in two ranks, are two yards in rear of their pieces.

In both kinds of artillery, these arrangements for the column are the same whether the pieces or caissons lead.

ORDER IN LINE.

126. (Pl. 17.) *The order in line* is that in which the carriages are formed in two lines; the horses all facing in the same direction, the pieces limbered, and each followed or preceded by its caisson.

The captain is generally 4 yards in front of the centre. But, during the manœuvres, he goes wherever his presence may be most necessary, and where his commands may be best heard.

Each chief of section is in line with his leading drivers, and midway between the leading carriages of his section.

The chief of the line of caissons is opposite the centre, 4 yards behind the rear line of carriages.

Order in Line.

Foot Artillery.

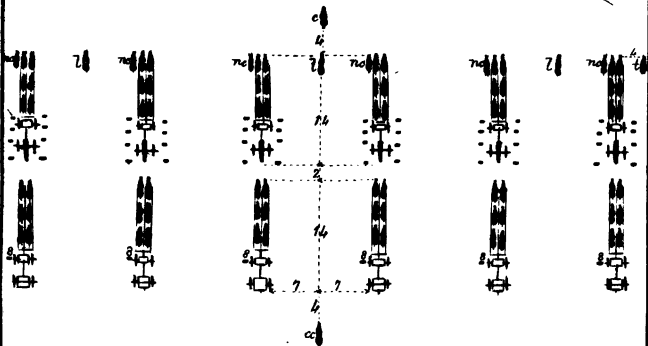

Order in Line.

Horse Artillery.

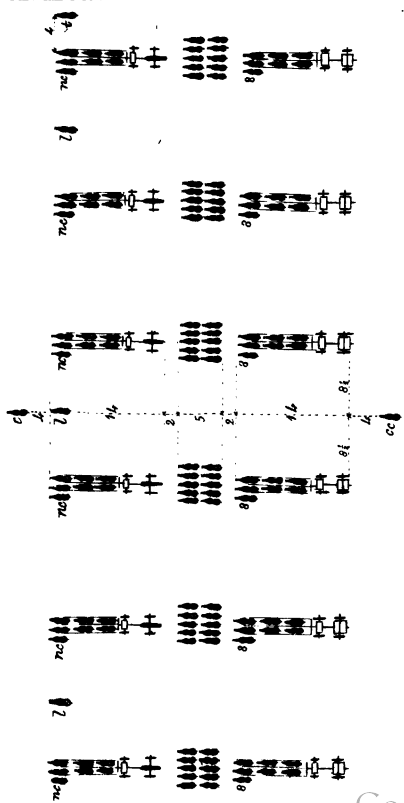

Foot Artillery:

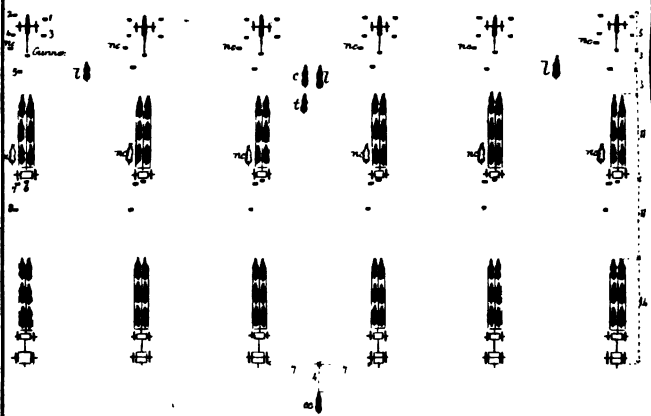

Order in Battery

Horse Artillery:

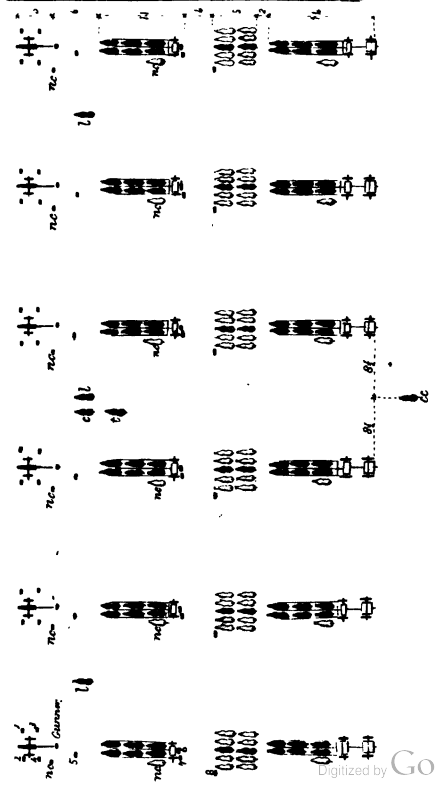

Each chief of piece and caisson is in the same position as in column.

The trumpeter, when he does not accompany the captain, is in line with the leading drivers, and 4 yards from the right flank.

In foot artillery.

The interval between the carriages is 14 yards.

The distance between the two lines is 2 yards.

The cannonéers are at their posts as in column.

In horse artillery.

The interval between the carriages is 17 yards.

The distance between the lines of pieces, detachments, and caissons, is 2 yards.

The detachments are two yards in rear of their pieces.

In both kinds of artillery, these arrangements for the line are the same whether the pieces or caissons lead.

ORDER IN BATTERY.

127. (Pl. 18.) *The order in battery* is that in which the pieces are prepared for firing; the pieces, limbers, and caissons being turned towards the enemy, and formed in three parallel lines.

The captain is generally on the left of the chief of the centre section; but he may go wherever his presence is required.

Each chief of section is habitually in the centre of his section, half way between the lines of pieces and limbers.

The chief of the line of caissons is opposite the centre, four yards in rear of the line of caissons.

Each chief of piece is outside the file on the left of his piece; but near it, and opposite the middle of the trail handspike. During the real execution of the firings, he habitually dismounts and gives the reins of his horse to the driver of the wheel horses of the limber.

Each chief of caisson is on the left, and 4 yards in rear of the limber of the piece. In horse artillery he

gives the reins of his horse to the driver of the wheel horses of the caisson.

The trumpeter is near the captain.

In foot artillery.

The interval between the pieces is 14 yards.

The distance between the lines of pieces and limbers is 6 yards, measuring from the end of the handspike to the heads of the leading horses.

The distance between the lines of limbers and caissons is 11 yards, measuring from the rear of the limbers to the heads of the leading horses of the caissons.

The cannoneers are at their posts.

In horse artillery.

The interval between the pieces is 17 yards.

The distance between the lines of pieces and limbers is 6 yards; measured as before.

The distance between the lines of limbers and caissons is 11 yards; measured as before.

The cannoneers are at their posts.

The detachments of horses are four yards in rear of the limbers.

The regular formation in battery should be always preserved in the manœuvres. But on the field of battle the front would be commonly more extended; the pieces being posted so as to obtain the greatest advantage from the nature of the ground, and the caissons sheltered as much as possible.

When the battery retires firing, the horses and drivers in both kinds of artillery remain faced to the rear, after the first retrograde movement, that they may be ready to continue it.

REMARKS ON THE FORMATIONS OF THE BATTERY.

128. During the manœuvres the captain is followed by a trumpeter, who must not leave him. On receiving an order from the captain for that purpose he takes the place assigned him in the order in line.

129. The *double column* is a particular case of formation in column with a front of two pieces. It is formed on the centre section as head of the column; each of the other sections being in column of pieces in rear. When the battery contains but four pieces the double column is formed upon the two central pieces as before.

130. When the caissons are detached, which is frequently the case with horse artillery, and sometimes with foot, the intervals and distances between the pieces for manœuvring, will be the same as though the caissons were present; so that the necessary ground for wheeling into line, &c. may be preserved. Batteries should be practised in this kind of manœuvring accordingly.

131. When all the carriages are drawn by 4 horses, in manœuvring, the distances will remain as usual; but the intervals will be diminished 3 yards. Should a portion of the carriages be reduced a pair of horses or more, allowance must be made for the deficient horses, and the distances of these carriages increased accordingly, estimating the length of a horse in harness at 6 yards.

MEASURES OF THE ELEMENTS COMPOSING A BATTERY, AND OF ITS FORMATIONS.

132. The measures given in the three orders of the battery, and those which will be given hereafter, result from the dimensions of the different elements embraced. Those dimensions are given in the following table.

The numbers adopted, having been chosen to avoid fractions, will be found to differ slightly from the exact measures. But as it is extremely difficult, and not very important, to secure precision in the manœuvres, the difference is of little consequence.

	Depth.	Front.
Piece drawn by 6 horses - - - - -	14yds.	2yds.
Caisson drawn by 6 horses - - - - -	14 "	2 "
Limber drawn by 6 horses - - - - -	11 "	2 "
Piece in battery with handspike - - - - -	5 "	2 "
Detachment of horse cannoners - - - - -	5 "	5 "

	Foot artillery.		Horse artillery	
	Depth.	Front.	Depth.	Front.
Column of sections - -	94yds.	18yds.	115yds	21yds.
Line of battle - - -	30 "	82 "	37 "	97 "
Line in battery - - -	47 "	82 "	47 "	97 "
Section in line - - -	30 "	18 "	37 "	21 "
Section in battery - -	47 "	18 "	47 "	21 "

MANNING THE BATTERY.

133. The battery is taken at the park.

The company is formed by detachments; each containing the cannoneers of one piece, arranged from right to left in the following order.

FRONT RANK.

Gunner.
No. 2.
No. 4.
No. 6.
No. 8.

REAR RANK.

No. 1.
No. 3.
No. 5.
No. 7.

In *horse artillery* the two horse holders are placed in the centre of the detachment; one in each rank.

The company and teams, having been properly told off, are marched to the battery with the teams in front.

The chiefs of pieces and caissons, when mounted, march with the teams. The whole are conducted to the battery, the teams hitched, and detachments posted, as prescribed in the schools of the driver and piece.

In *horse artillery* each detachment may march, when more convenient, in rear of the team belonging to its piece.

When the nature of the ground requires, the detachments are halted outside the park, and marched to their posts successively as the pieces file out.

134. As soon as the teams are hitched and cannoneers posted, a minute inspection is made by the chiefs of

pieces, who report to the chiefs of sections; and a similar inspection is made by the chiefs of sections, who report to the captain.

The chiefs of sections are at all times responsible for the good appearance and serviceable condition of every thing belonging to their sections.

135. When the cannoneers are at their posts in time they may be required to hitch instead of the drivers. When this is to be done the drivers are not dismounted. At the command *Cannoneers*—*HITCH*, Nos. 1, 2, 3, and 4 hitch the horses of the caissons; the gunner and Nos. 5, 6, and 7 those of the piece. Each hitches on his own side; Nos. 1, 2, 5, and the gunner attending to the wheel horses.

The command *Cannoneers*—*UNHITCH* is executed in a corresponding manner.

TO UNPARK.

136. Every thing being prepared for manœuvring, if the captain wishes to unpark by the right he commands:

1. *By piece—from the right—front into column.*
2. *MARCH.*

At the command *MARCH*, the right piece, followed by its caisson, marches direct to the front, and the captain indicates the direction it should take. The other pieces and caissons follow the movement of the right piece, each so regulating its march by that which precedes it, as to march in the same direction and two yards behind. Each chief of section directs the march of his carriages, which are so conducted by their chiefs as to enter the column by the most simple movement. The column of pieces is thus formed with a distance of two yards between the carriages; and in horse artillery with the same distance between the carriages and detachments.

The captain goes wherever his duty may require, but generally remains on the left flank, opposite the centre of the column.

The chief of the leading section places himself near

the chief of the leading piece, and on his left; the other chiefs of sections four yards from the left flank, abreast the centres of their respective sections.

The chief of the line of caissons is in rear of the chief of the centre section.

Each chief of piece and caisson, when mounted, is near his leading driver, on the left.

The trumpeter is near the captain.

When the battery is parked with the caissons in front, the captain causes it to unpark by the right by the same commands; the movements being executed in the same manner.

The battery may be unparked by the left according to the same principles and by inverse means. The commands are :

1. *By piece—from the left—front into column.*

2. MARCH.

137. The column of pieces is not to be considered a column of manœuvre. It will be changed into a column of sections as soon as the nature of the ground will permit. But the exigencies of service sometimes require that formations into line and battery should be made directly from the column of pieces. In such cases, the principles and commands laid down for similar formations from the column of sections, will govern. In the formations to the right or left, the pieces must close up, and wheel successively when opposite their proper places.

TO HALT.

138. To halt the battery, when marching in column of pieces, the captain commands :

1. *Column.*

2. HALT.

At the second command, repeated by the chiefs of sections, all the carriages are immediately halted. (No. 81.)

CHANGE OF GAIT.

139. The changes of gait, in column of pieces, are executed by the following commands from the captain :

To form Sections.

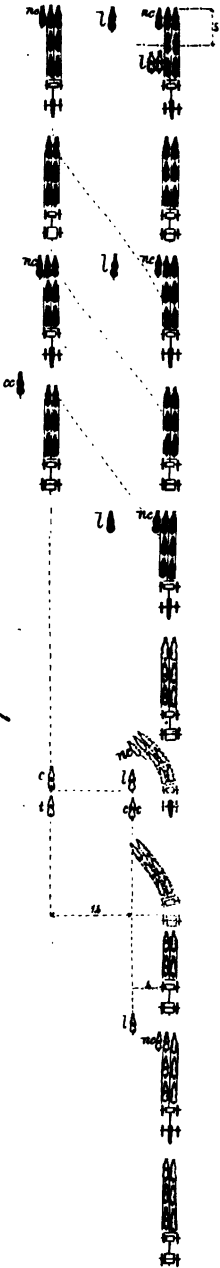

To break Sections.

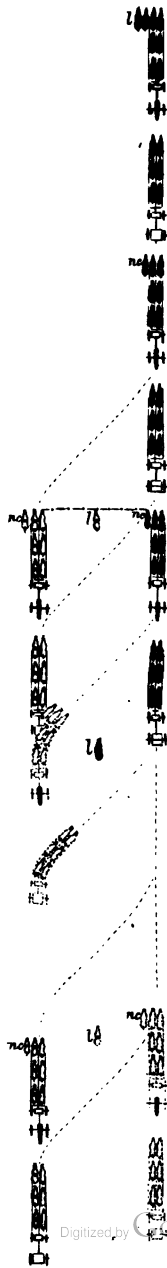

To pass from the walk to a trot.

1. *Trot.*
2. MARCH.

To pass from the trot to a walk.

1. *Walk.*
2. MARCH.

At the first command, repeated by the chiefs of sections, all the drivers and others on horseback prepare to change the gait; and at the second, repeated in like manner, they pass at once to the gait indicated by the first command.

TO FORM SECTIONS.

140. When the battery is marching at a walk in column of pieces, to form sections at the same gait by gaining ground to the left, the captain commands:

1. *Form sections—left oblique.*
2. MARCH.
3. *Guide right.*

(Pl. 19.) The chief of the leading section repeats the commands, *Form section—left oblique—MARCH—Guide right*, in succession after the captain. At the command MARCH, the two first carriages, piece and caisson, continue to march, and halt when they have advanced five yards. The two following gain their interval of 14 yards by obliquing to the left, and place themselves abreast and parallel with the other two.

The other sections continue to march in column of pieces, and are formed successively by their chiefs; each commanding, *Form section—left oblique*, in time to command MARCH, when the leading carriage of his section has arrived within five yards of its distance. The chief of section then commands: *Guide right.*

When the column of pieces is marching at a trot, the formation is executed according to the same principles and by the same commands. But the leading carriages, instead of advancing five yards and halting as before, pass to a walk as soon as the command MARCH is re-

peated by the chief of section. The other sections continue to march at a trot, and execute the movement at that gait; the two leading carriages of each section passing to a walk at the command MARCH, which must be given when they have closed to their proper distance.

When the column of pieces is at a halt, the formation is executed as prescribed for the column at a walk. In this case the carriages all move at the command MARCH, and the leading ones halt after advancing five yards.

When the column of pieces is marching at a walk, to form sections at a trot gaining ground to the left, the captain commands :

1. *Form sections—left oblique—trot.*
2. MARCH.
3. *Guide right.*

The chief of the leading section repeats the commands, *Form section—left oblique—trot—MARCH—Guide right*, in succession, after the captain. At the command MARCH, the two leading carriages continue to march in the original direction at a walk. The two following oblique to the left, gain their interval at a trot, and resume the walk when opposite the leading carriages.

At the first command, the chiefs of the other sections command: *Trot*; and at the second, which they repeat, their sections commence the trot.

The chiefs of the second and third sections command, *Form section—left oblique*, in time to command MARCH, when the leading carriage of each section has nearly gained its distance. The leading carriage then resumes the walk, and the chief of section commands: *Guide right*.

The chiefs of sections superintend their carriages, and take the posts assigned them in the order in column as soon as their sections are formed, (No. 125.)

Sections are formed by gaining ground to the right according to the same principles and by inverse means. The commands are: *Form sections—right oblique—MARCH—Guide left*; or *Form sections—right oblique—trot—MARCH—Guide left*.

THE BATTERY BEING IN COLUMN OF PIECES TO FORM THE CAISSONS ON THE FLANK.

141. When the battery is in column of pieces with the caissons in rear, to form the pieces and caissons into separate columns, as in the flank march of a battery in line, the captain commands :

1. *Caissons left*, (or *Caissons left—trot.*)
2. MARCH.
3. *Guide right.*

These commands are repeated by the chiefs of sections, the caissons oblique at once to the left, gain the interval of 14 yards, and place themselves opposite their pieces ; the pieces closing upon each other at the same time to the usual distance. The gait is regulated as in the formation of sections ; and when the movement is performed at a walk, the leading carriage halts after advancing its own length.

The chiefs of sections take their places as in column of sections.

The caissons are formed on the right according to the same principles and by inverse means.

When the pieces are in rear, they are formed on the right or left of their caissons in the same manner and by corresponding commands.

TO MARCH IN COLUMN.

142. The battery being in column at a halt, to advance, the captain commands :

1. *Column—forward.*
2. MARCH.
3. *Guide left* (or *right.*)

The commands, *Forward—MARCH—Guide left* (or *right,*) are repeated by the chiefs of sections. At the command MARCH, all the carriages advance, the guide maintains the direction, and the carriages, as well as the detachments of horse cannoneers, preserve their intervals and distances.

TO HALT THE COLUMN.

143. The column is halted as in No. 81.

TO CHANGE THE GAIT.

144. The gaits are changed as in No. 139.

TO MARCH BY A FLANK.

145. The battery being in column, in march or at a halt, to gain ground to the left, the captain commands:

1. *Column—by the left flank.*
2. MARCH.

(Pl. 20.) The commands, *By the left flank—MARCH*, are repeated by the chiefs of sections. At the command MARCH, each carriage wheels at once to the left, (No. 82.)

When the wheel is nearly completed the captain commands:

1. FORWARD.
2. *Guide right.*

These commands are repeated by the chiefs of sections. At the command FORWARD, all the carriages march direct to the front.

The line is regularly established, and the carriages aligned in each rank, with their distances of two, and intervals of fourteen yards. The chiefs of sections take their places between the leading carriages as in line.

To cause the battery to resume its original direction, the captain commands:

1. *Battery—by the right flank.*
2. MARCH.
3. FORWARD.
4. *Guide left.*

The commands, *By the right flank—MARCH—FORWARD—Guide left*, are repeated and executed according to the principles before described.

After the flank march, to march the battery in a direction opposite to the original one, the captain commands:

To march to the left flank.

Foot Artillery.

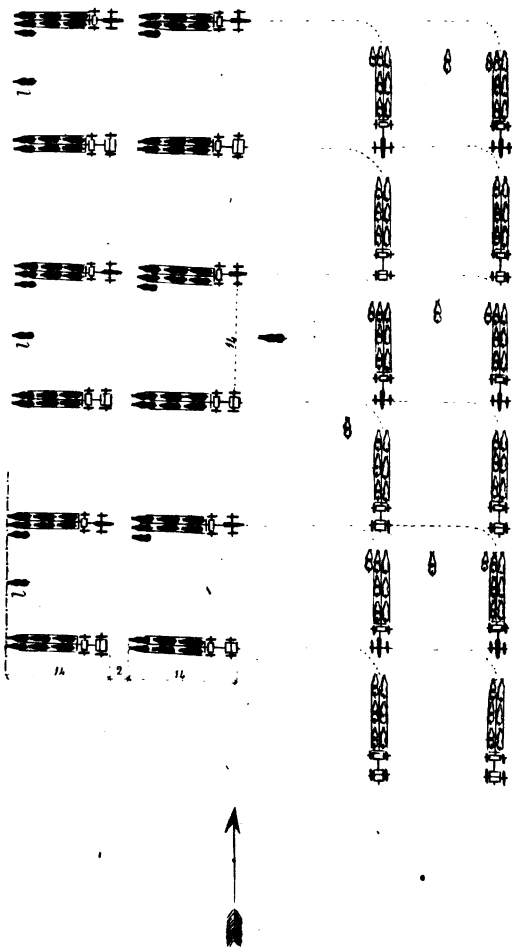

To march to the left flank.
Horse Artillery:

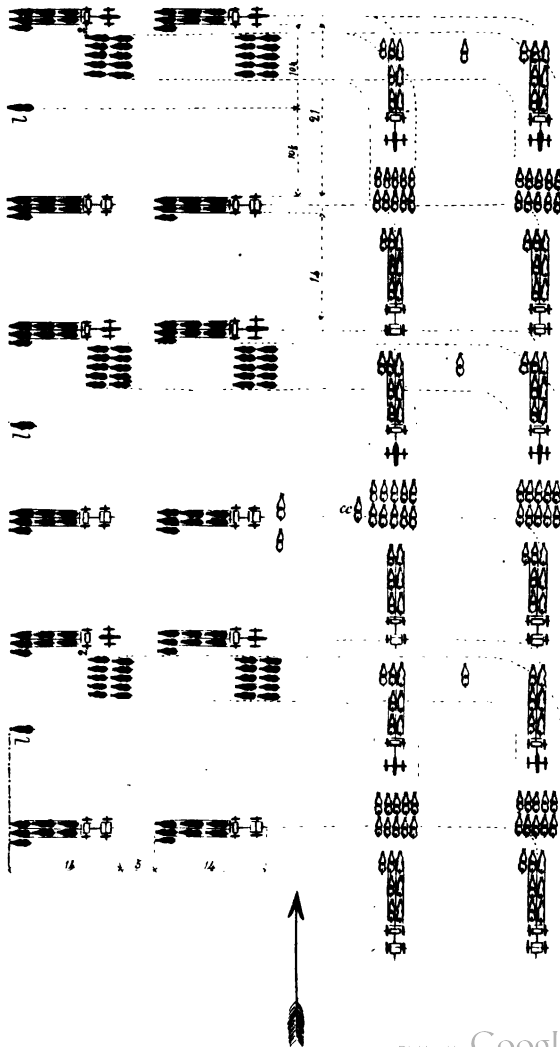

1. *Battery—by the left flank.*
2. MARCH.
3. FORWARD.
4. *Guide right.*

(Pl. 21.) *In horse artillery* the flank march is executed according to the same principles, and by the same commands. The line formed by the flank movement is established, and the carriages aligned in each rank, with distances of five and intervals of fourteen or twenty-one yards, according to the relative position of the pieces and caissons. The detachments wheel in the same direction as their pieces; and, after following them during a part of the movement, place themselves by their sides, two yards from the wheels, with the heads of their leading horses on a line with the axle-trees of the limbers. In marching by the left flank they are on the left of their pieces, and the reverse when marching by the right. When sufficient ground has been gained to the flank, and the battery resumes its formation in column by marching in the original direction, the detachments wheel in the same direction as their pieces and place themselves in their rear. But when the march in column is in the opposite direction, they resume their places by allowing their pieces to pass them and then falling in their rear.

The flank march, to gain ground to the right, is executed according to the same principles and by inverse means.

In each case the captain and the chief of the line of caissons change their direction to the left or right, and conform to the movements of the battery.

OBLIQUE MARCH.

146. The battery being in column, in march or at a halt, to cause it to march obliquely to gain ground to the front and left, the captain commands:

1. *Column—left oblique.*
2. MARCH.
3. *Guide right*

(Pl. 22.) The chiefs of sections repeat the commands, *Left oblique—MARCH—Guide right.* At the command **MARCH**, all the carriages oblique at once to the left (No. 116) and march direct to the front in the new direction; moving in parallel lines, dressing by the right, and preserving their intervals from that flank.

In obliquing, the heads of the horses in each rank are on a line parallel to the original front of the column. The interval between the carriages is fourteen yards, measured parallel to the front; and only ten if measured perpendicularly to the oblique direction. Each carriage of the right file marches in the prolongation of the left carriage of the rank which precedes its own, and at a distance of nine yards.

The officers conform to the movement and preserve their relative positions.

To resume the original direction the captain commands :

FORWARD.

This command is repeated by the chiefs of sections, and the carriages resume the original direction by obliquing to the right.

If the captain wishes to halt the column for the purpose of rectifying its alignments, intervals, or obliquity, he commands :

1. *Column.*
2. **HALT.**

And to resume the march in the oblique direction :

1. *Column.*
2. **MARCH.**
3. *Guide right.*

The commands, **HALT—MARCH—Guide right**, are repeated by the chiefs of sections.

(Pl. 23.) In *horse artillery* the carriages oblique to the left according to the principles prescribed for foot artillery. They also form ranks whose fronts are parallel to the original front of the column.

The oblique march.
Foot Artillery.

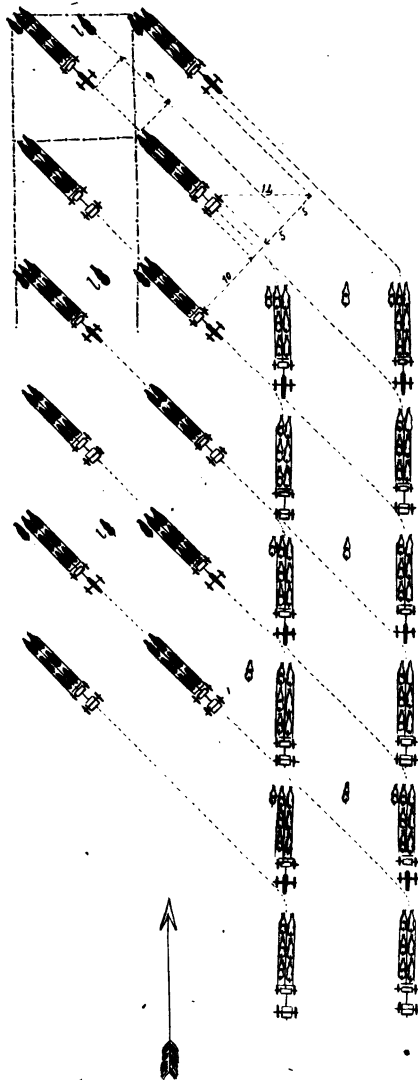

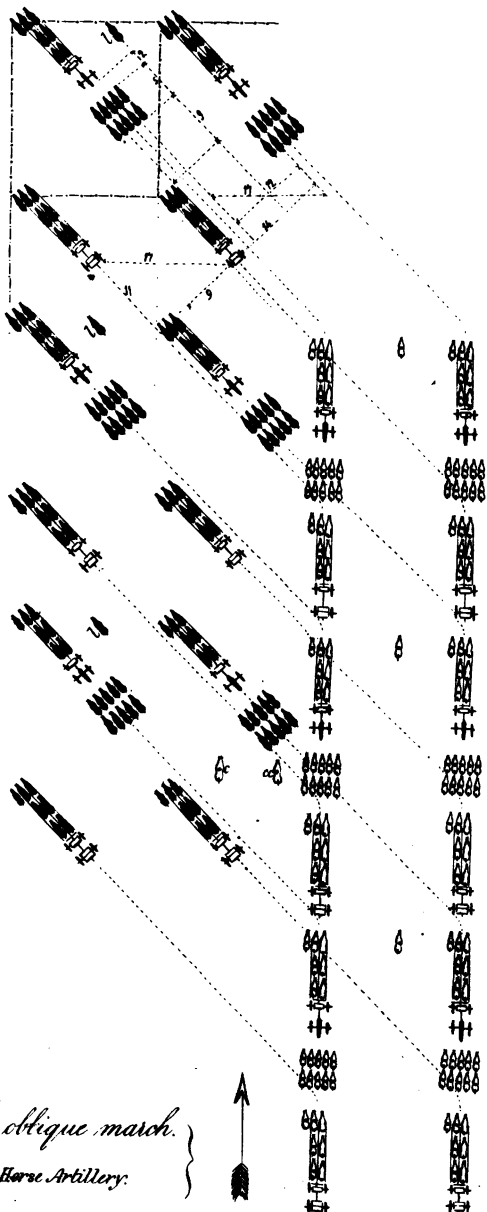

The oblique march.
Horse Artillery.



The right oblique is executed according to the same principles and by inverse means.

In each case the captain and the chief of the line of caissons change their direction to the left or right, and conform to the movements of the battery.

PASSAGE OF CARRIAGES IN COLUMN.

147. When the battery is marching in column at a walk, to change the relative positions of the front and rear ranks, without altering the gait, the captain commands :

1. *Pieces pass your caissons, (or caissons pass your pieces.)*
2. MARCH.

These commands are repeated by the chiefs of sections ; and at the command MARCH, the leading carriages of each section halt. Those of the rear rank execute the passage (No. 117) without changing the gait, and halt as soon as they have reached their positions in front.

To continue the march without halting the carriages of the rear rank, the captain commands : FORWARD, when the passage is nearly completed, and the command is repeated by the chiefs of sections.

When the column is marching at a trot, the passage is executed according to the same principles and by the same commands, except that the carriages of the front rank move at a walk instead of halting at the command MARCH. The carriages of the rear rank execute the passage at a trot, and then change the gait to a walk.

When the column is at a halt, the passage is executed according to the same principles and by the same commands. If the captain wishes to put the column in march immediately after the movement, he commands : FORWARD, when the passage is about being completed, and then, *Guide left (or right.)* These commands are repeated by the chiefs of sections.

When the column is marching at a walk, to execute the passage at a trot, the captain commands :

1. *Pieces pass your caissons—trot, (or caissons pass your pieces—trot.)*
2. MARCH.

These commands are repeated by the chiefs of sections. At the command MARCH, the carriages of the front rank in each section continue to march at a walk. Those of the rear rank execute the passage at a trot, and resume the walk as soon as the passage is completed.

ABOUT IN COLUMN.

148. The battery being in column, in march or at a halt, to face it to the rear, the captain commands :

1. *Pieces and caissons—left about.*
2. MARCH.

These commands are repeated by the chiefs of sections; and at the second all the carriages execute the about, (No. 118.) When the movement is about being completed, the captain commands: *Column—HALT*; or *FORWARD—Guide right (or left;)* the commands, *HALT*, or *FORWARD—Guide right (or left,)* are repeated by the chiefs of sections.

COUNTERMARCH IN COLUMN.

149. The battery being in column, in march or at a halt, to execute the countermarch in each section, the captain commands :

1. *Countermarch.*
2. MARCH.

These commands are repeated by the chiefs of sections, and at the second each piece and its caisson execute the countermarch, (No. 119.) When the movement is about being completed the captain commands: *Column—HALT*; or *FORWARD—Guide right (or left.)*

These commands are repeated as in the preceding paragraph.

Change of direction to the left.

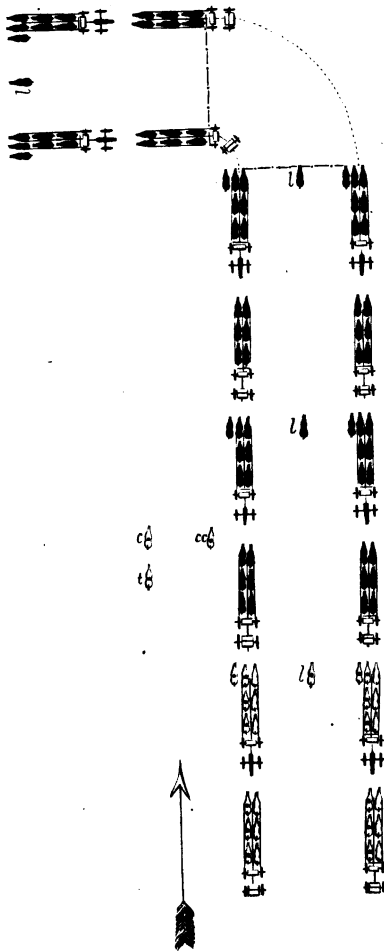

TO CHANGE DIRECTION IN COLUMN.

150. The battery being in column, in march or at a halt, to cause it to change direction to the left, the captain commands :

Head of column to the left.

(Pl. 24.) The chief of the leading section commands: *Left wheel*—MARCH; and afterwards: FORWARD. At the command MARCH, the pivot carriage executes the wheel without changing the gait. The carriage on the wheeling flank, wheels in such a manner as to conform to its movement; increasing the gait, and preserving the intervals, (No. 120.) At the command FORWARD, the pivot carriage moves direct to the front and the other resumes its original gait after completing the wheel and arriving upon the same line. The carriages of the rear rank preserve their distance and follow those of the front rank.

Each of the other sections, on arriving at the point where the first wheeled, executes the same movement, and by the same commands from its chief.

Each chief of section must give the command *Left wheel* in time to command MARCH, when the heads of his leaders are three yards from the wheeling point. And the command FORWARD must be given, as soon as the leading pivot carriage has entered the new direction.

The change of direction to the right is executed according to the same principles and by inverse means.

An oblique change of direction is executed according to the same principles, by the command :

Head of column—left (or right) half wheel.

The chiefs of sections command, successively: *Left (or right) half wheel*—MARCH—FORWARD; the command FORWARD being given, in this case, when the leading pivot carriage of each section is about finishing the left or right oblique.

TO DIMINISH THE FRONT OF A COLUMN ON THE MARCH.

151. The battery marching at a walk in column of sec-

tions, to form column of pieces from the right, at that gait, the captain commands :

1. *By the right—break sections.*
2. MARCH.

(Pl. 19.) The chief of the leading section commands, successively, after the captain: *By the right—break section—MARCH.* At the command MARCH, the two right carriages of the leading section continue to march at a walk, and all the other carriages halt. The left carriages of the leading section remain halted, until the leaders of the leading carriage are passed by the wheel horses of the rear carriage on the right. They then oblique to the right, take their places in column, and follow the two leading carriages. The other sections are broken in succession by the same commands from their chiefs; the command MARCH being given when the wheel horses of the left carriages of the next preceding section enter the right oblique.

When the column is marching at a trot, the column of pieces is formed according to the same principles and by the same commands. But in this case the carriages which halted before slacken the gait to a walk, and resume the trot to oblique and enter the column.

When the column is at a halt, the movement is executed as prescribed for a column marching at a walk; the two right carriages of the leading section moving forward at a walk at the command MARCH.

The battery marching at a walk in column of sections, to form column of pieces from the right at a trot, the captain commands :

1. *By the right—break sections—trot.*
2. MARCH.

The chief of the leading section commands successively, after the captain: *By the right—break section—trot—MARCH;* and the right carriages of the leading section move forward at a moderate trot. The left carriages of the same section commence the trot on obliquing to enter the column.

The other sections are broken successively by the same commands from their chiefs; and the carriages are regulated by each other, as in breaking sections at a walk.

This formation is executed from the left, according to the same principles and by inverse means.

IN COLUMN WITH THE CAISSONS ON THE FLANK, TO REPLACE THEM IN FRONT OR REAR.

152. The battery being in column with the caissons on the flank, to re-establish them in rear of their pieces, the captain commands:

1. *Caissons rear, (or caissons rear—trot.)*
2. MARCH.

Each chief of section repeats the commands in time to command MARCH, when the leading piece of his section is to commence the movement. The piece at the head of the column moves forward with the required gait, and its caisson places itself in rear by an oblique. The other pieces move forward in succession and are followed by their caissons in like manner.

All the carriages preserve the usual distance in column.

This movement is performed with the different gaits, and according to the principles prescribed for breaking sections, (No. 151.)

The formation for placing the caissons in front is executed by the commands, *Caissons front (or caissons front—trot)*—MARCH, the caissons obliquing successively in front of their pieces.

TO FORM THE PARK.

153. The battery being in column of pieces, and near the ground on which it is to be parked, will be formed by the commands, and according to the principles prescribed in Nos. 102, 103, or 104. Each chief of section directs the march of his carriages, and each carriage is conducted to its place in park by its particular

chief. When the nature of the ground requires, the detachments are ordered to leave their pieces successively when they are about entering the park. In this case they leave by the flanks of the column, and are formed in line on the ground designated for the purpose. The detachments and teams are marched from the park according to the principles prescribed in Nos. 106 and 133.

TO PASS FROM THE ORDER IN COLUMN TO THE ORDER IN LINE, AND THE REVERSE.

In all the formations in line or column, the movements are the same whether the pieces or caissons lead.

FORWARD INTO LINE.

154. The battery being in column at a halt, to form it into line on the head of the column, gaining ground to the left, the captain commands :

1. *Forward into line—left oblique.*
2. MARCH.
3. *Guide right.*
4. FRONT.

(Pl. 25.) At the first command, the chief of the leading section commands: *Section—forward*, and those of the other sections, *Section—left oblique*. At the command MARCH, repeated by the chiefs of sections, the leading section moves to the front, and its chief repeats the command for the guide. After advancing 15 yards, or for horse artillery 22, he commands: *Section—HALT—Right—DRESS.*

Each of the other chiefs of sections, repeats the command for the guide, and conducts his section by a left oblique, until by the direct march it may gain its proper interval from the section immediately on its right. He then commands: FORWARD, and when within four yards of the line, *Section—HALT—Right—DRESS.*

When the battery is aligned the captain commands: FRONT.

The movement is executed on the opposite flank according to the same principles and by inverse means.

Forward into line.

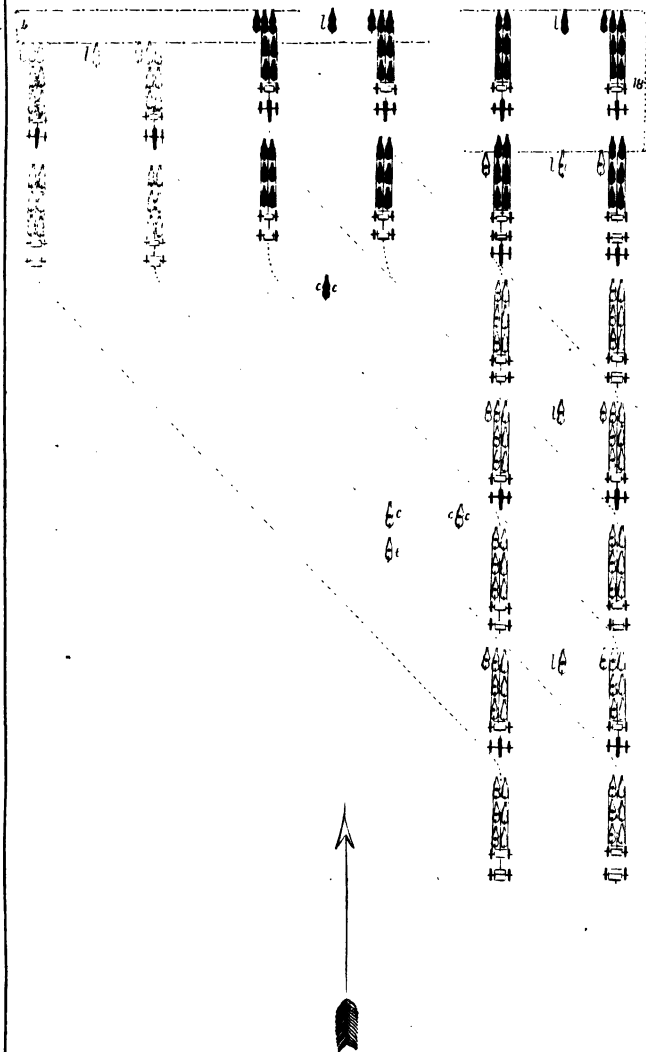

Into line faced to the rear.

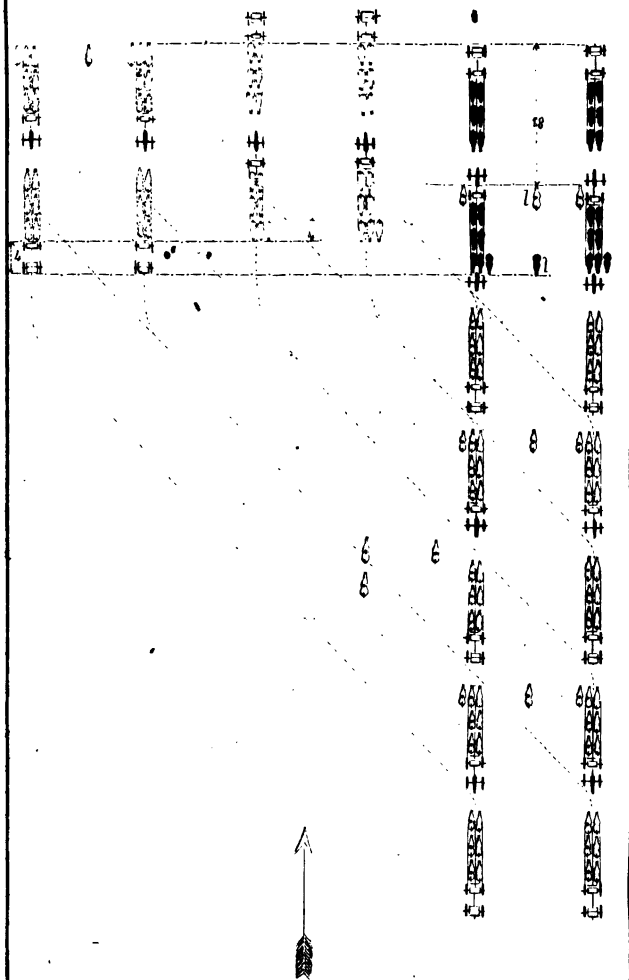

In this case the commands are: *Forward into line—right oblique—MARCH—Guide left—FRONT.*

The formation forward into line by a right or left oblique, is executed in a similar manner when the column is in march. In this case the chief of the leading section gives no command except for the guide, until he has advanced the distance before prescribed. He then halts his section as before.

TO FORM LINE FACED TO THE REAR.

155. The battery being in column at a halt, to form it into line faced to the rear, on the head of the column, gaining ground to the left, the captain commands :

1. *Into line faced to the rear—left oblique.*
2. MARCH.
3. *Guide right.*
4. FRONT.

(Pl. 26.) At the first command, the chief of the leading section commands: *Section—forward*; and those of the other sections: *Section—left oblique.* At the command MARCH, repeated by the chiefs of sections, the movement is executed as in No. 154, with the exception of the alignment. When the leading section has advanced 18 yards, or for horse artillery 22, it is halted by its chief until the centre section arrives upon the same line. He then commands: *Countermarch—MARCH*; and when the countermarch is nearly completed, *Section—HALT—left—DRESS.*

The centre section is halted upon the line in like manner until the left section comes up, and is then countermarched and aligned by the same commands.

When the left section arrives upon the line, it is countermarched before halting, and then aligned like the rest.

When the centre and left sections are countermarched, the commands, *HALT—Left—DRESS*, should be given, if possible, when they are four yards in rear of the line on which the leading section is established.

When the battery is aligned the captain commands :
FRONT.

The movement is executed on the opposite flank according to the same principles and by inverse means. In this case the commands are: *Into line faced to the rear—right oblique—MARCH—Guide left—FRONT.*

The formation into line faced to the rear by a right or left oblique, is executed in a similar manner when the column is in march. In this case, as the leading section is already in motion, its chief only repeats the command for the guide as in No. 154.

TO FORM LINE TO THE RIGHT OR LEFT.

156. The battery being in column, in march or at a halt, to form it into line to the left, the captain commands :

1. *Left into line wheel.*
2. MARCH.
3. *Battery—HALT.*
4. *Left—DRESS.*
5. FRONT.

(Pl. 27.) At the first command, the chiefs of sections command: *Section—left wheel*; and at the second, which they repeat, all the sections wheel to the left. Each chief of section commands: *Forward—Guide left*, as soon as his leading pivot carriage has taken the new direction.

When the rear carriages have completed the wheel, and the sections are in line, the captain commands: *Battery—HALT—Left—DRESS.*

The commands, *HALT—Left—DRESS*, are repeated by the chiefs of sections, and when the alignment is completed the captain commands: FRONT.

The battery is formed into line to the right according to the same principles and by inverse means.

TO FORM LINE ON THE RIGHT OR LEFT.

157. The battery marching in column to form it into line on the right, the captain commands :

To the left into line.

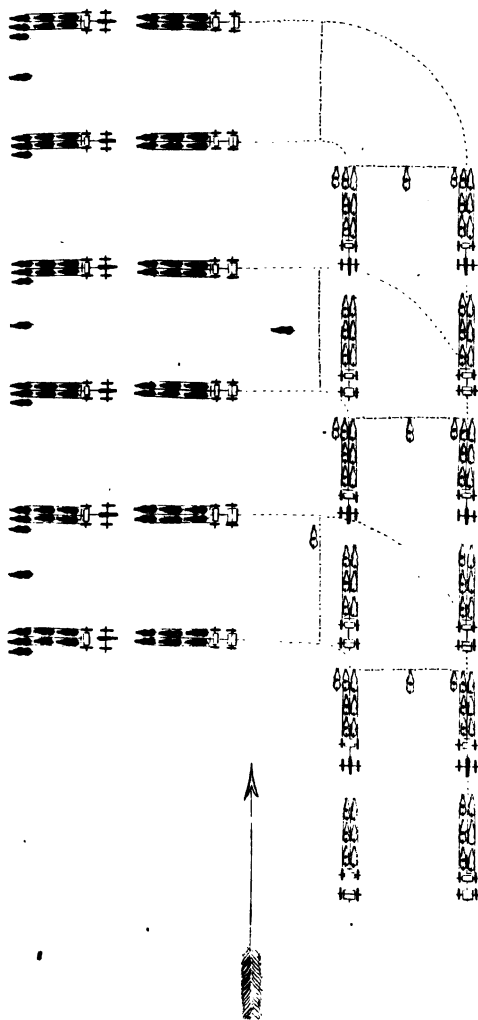

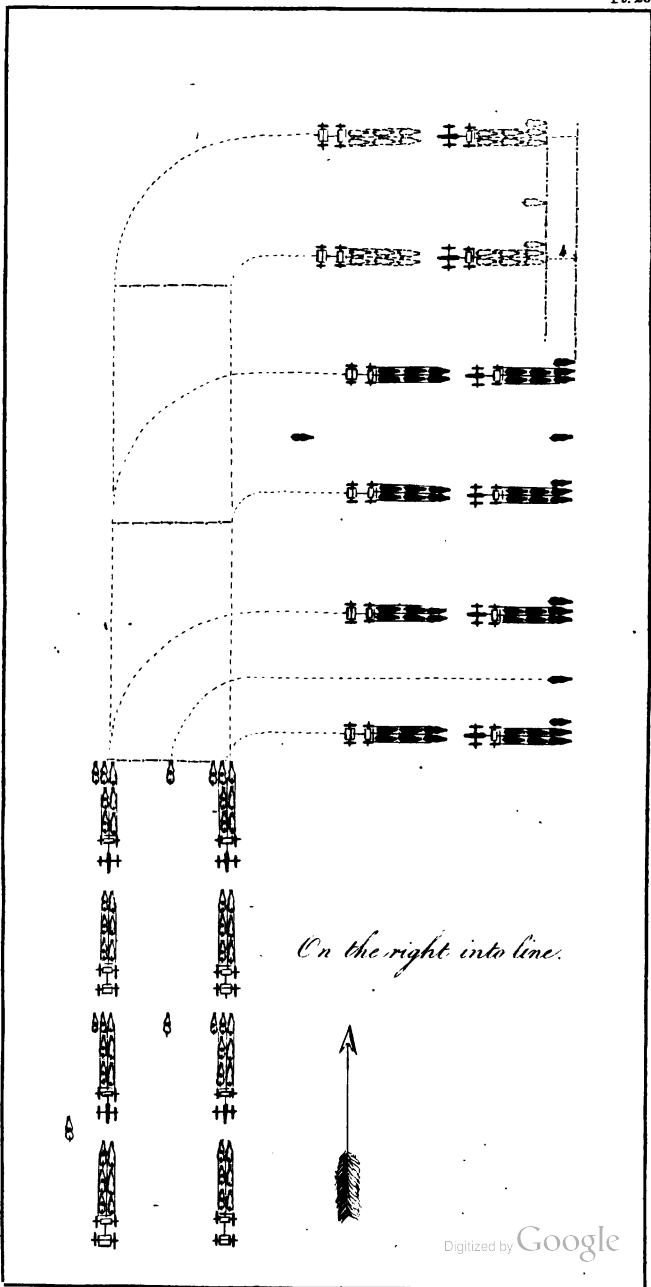

On the right into line.



1. *On the right into line.*
2. MARCH.
3. *Guide right.*
4. FRONT.

(Pl. 28.) At the first command, the chief of the leading section commands: *Section—right wheel*; and at the second, which he repeats, the section wheels to the right. As soon as the leading pivot carriage enters the new direction he commands: *FORWARD—Guide right*; and as the section completes the wheel, and un.masks the column, he commands: *Section—HALT—Right—DRESS.*

The chiefs of the other sections repeat the command for the guide, and their sections continue to move forward. As each section passes the one preceding it in the formation, its chief establishes it on the line, with the proper interval, by the same commands. The commands, *Section—HALT—Right—DRESS*, are given when the section is four yards in rear of the line.

When the battery is aligned the captain commands: **FRONT.**

The line is formed on the left according to the same principles and by inverse means. The commands are: *On the left into line—MARCH—Guide left—FRONT.*

When the column is at a halt, the line is formed on the right or left in the same manner. In this case, the chiefs of the two rear sections command: *Section—forward*, and afterwards repeat the commands, *MARCH—Guide right (or left.)*

TO BREAK INTO COLUMN TO THE FRONT.

158. The battery being in line at a halt, to break into column to the front from the right, the captain commands:

1. *By section from the right—front into column.*
2. MARCH.
3. *Guide left.*

(Pl. 29.) At the first command, the chief of the right section commands: *Section—forward*; and those of the other sections: *Section—right oblique.* At the command

MARCH, repeated by the chief of the right section, that section moves forward, and its chief repeats the command for the guide.

Each of the other chiefs of sections repeats the commands, **MARCH—Guide left**, after the section on his right has commenced the movement, and when the leaders of its rear carriages are in line with him. After obliquing sufficiently to gain the rear of the preceding section he commands: **FORWARD**.

The movement is executed from the left according to the same principles and by inverse means.

TO BREAK INTO COLUMN TO THE REAR.

159. The battery being in line, in march or at a halt, to break into column to the rear from one of the flanks, the captain executes an about or a countermarch, according to the kind of carriage he may wish in front, then halts the battery, and breaks it into column to the front by the preceding manœuvre.

TO BREAK INTO COLUMN TO THE RIGHT OR LEFT.

160. The battery being in line, in march or at a halt, to break it into column to the left, the captain commands:

1. *By section—left wheel.*
2. **MARCH.**
3. **FORWARD.**
4. *Guide left.*

At the first command, the chiefs of sections command: *Section—left wheel*; and at the second, repeated by those chiefs, all the sections wheel to the left. When the wheels are nearly completed the captain commands: **FORWARD—Guide left**; and the chiefs of sections repeat the commands.

When the column is not to advance, the command, *Column—HALT* is substituted for **FORWARD—Guide left**.

(Pl. 30.) The battery is broken into column to the right according to the same principles and by inverse means.

To break into column to the front.

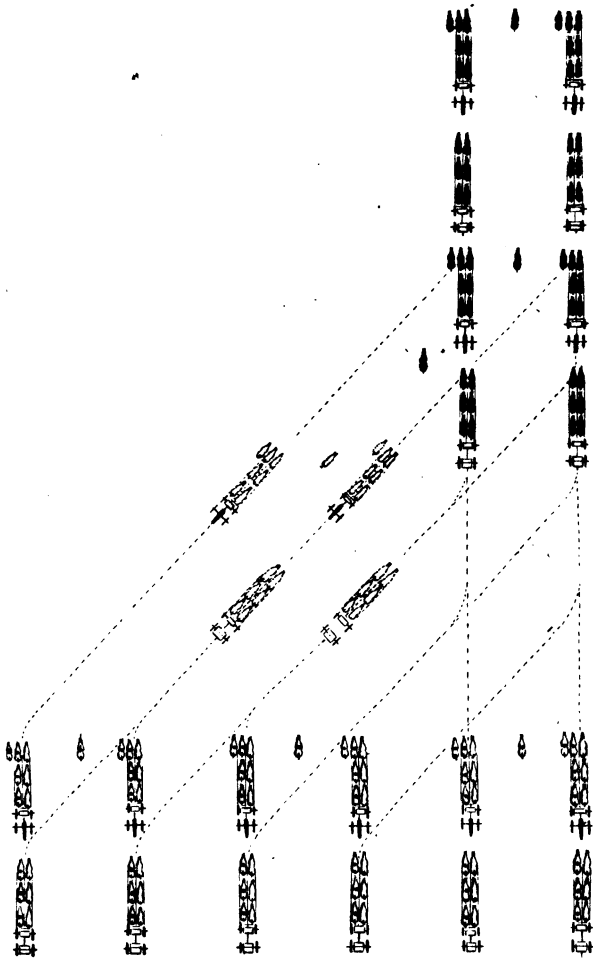

To break into column to the left.

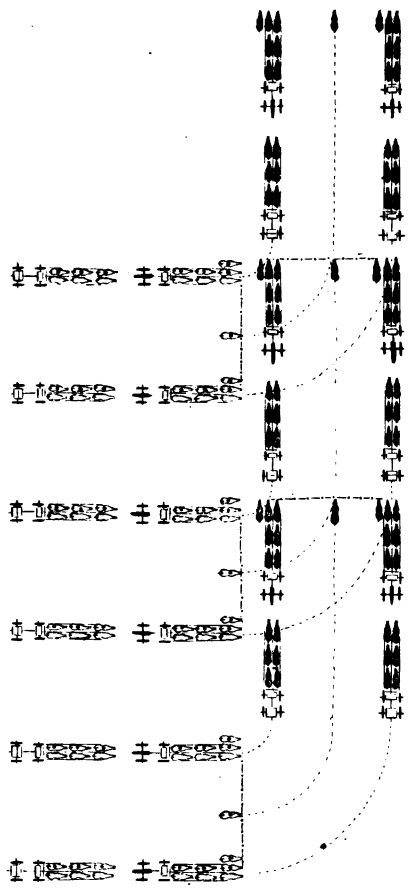

To break from the right to march to the left.

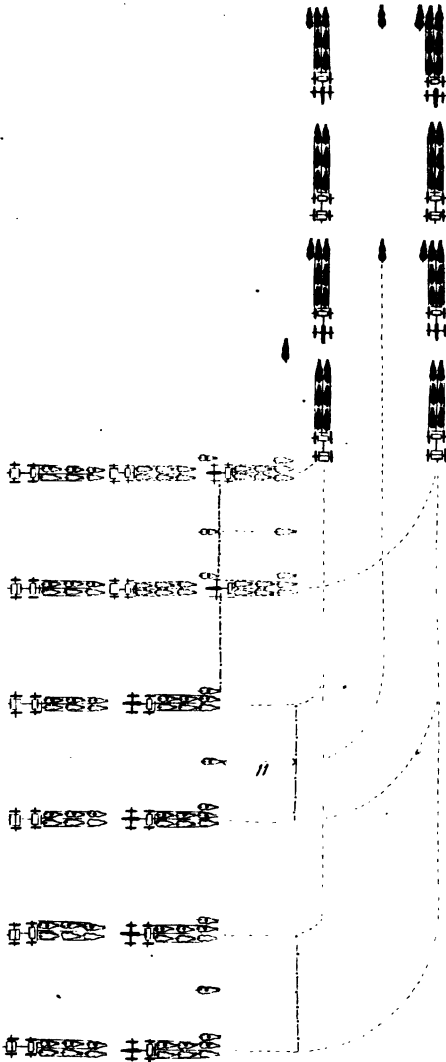

TO BREAK INTO COLUMN TO THE FRONT FROM ONE FLANK, TO MARCH TOWARDS THE OTHER.

161. The battery being in line at a halt, to break from the right to march to the left, the captain commands :

1. *By section—break from the right—to march to the left.*
2. MARCH.
3. *Guide left.*

(Pl. 31.) At the first command, the chief of the right section commands : *Section—forward*; and at the second, which he repeats, the section moves forward, and he commands : *Guide left*. After advancing eleven yards he changes the direction to the left by the commands, *Section—left wheel—MARCH—FORWARD*.

Each of the other chiefs of sections commands : *Section—forward*, in time to command MARCH when the limber wheels of the rear carriages in the section preceding his own arrive in front of him. He then conducts the section to the front, changes its direction to the left, and places it in rear of the preceding section by the commands already prescribed for the section on the right.

The battery is broken from the left to march to the right, according to the same principles and by inverse means.

TO BREAK INTO COLUMN TO THE REAR FROM ONE FLANK, TO MARCH TOWARDS THE OTHER.

162. The battery being in line at a halt, to break to the rear from one flank to march towards the other, the captain first executes an about or countermarch, according to the kind of carriage he may wish in front. He then halts the battery and executes the preceding manoeuvre.

TO BREAK INTO COLUMN TO THE FRONT, WHEN THE BATTERY IS MARCHING IN LINE.

163. The battery marching in line at a walk, to break into column to the front from the right, and at the same gait, the captain commands :

1. *By the right—break into sections.*
2. MARCH.
3. *Guide left.*

The chief of the right section repeats the command for the guide, and his section continues to move at the same gait. At the command MARCH, the other sections are halted by the command, *Section—HALT*, from their chiefs.

The halted sections are put in motion successively by their chiefs; each commanding, *Section—right oblique*, in time to command MARCH, when the leaders of the rear carriages in the section on his right arrive opposite to him. The sections oblique and enter the column as described in No. 158.

When the battery is marching at a trot, the movement is executed according to the same principles. But the sections which halted in the preceding case slacken the gait to a walk at the commands, *Walk—MARCH*, from their chiefs. They again trot and enter the column by the commands, *Section—right oblique—trot—MARCH—FORWARD*.

When the battery is marching in line at a walk, to break into column from the right at a trot, the captain commands :

1. *By the right—break into sections—trot.*
2. MARCH.
3. *Guide left.*

At the first command, the chief of the right section commands: *Trot*; and at the second, which he repeats, the section changes its gait to a trot. He afterwards repeats the command, *Guide left*.

Each of the other sections continues to march at a walk until required to enter the column, when its chief conducts it, as already described, by the commands, *Section—right oblique—trot—MARCH—FORWARD*.

The battery is broken into column from the left, according to the same principles and by inverse means.

To form double column.

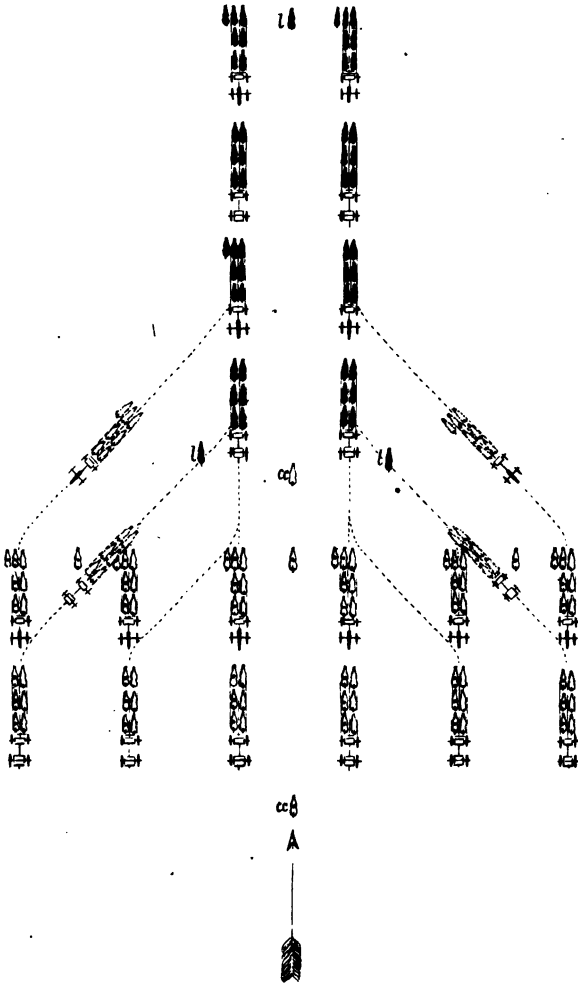

TO FORM LINE ADVANCING.

164. When the battery is marching in column at a walk, to form it into line at a trot gaining ground to the left, and continue the march, the captain commands :

1. *Form line advancing—left oblique—trot.*
2. MARCH.
3. *Guide right.*

The chief of the leading section repeats the command for the guide, and his section continues to move at a walk.

At the first command, the chiefs of the other sections command: *Section—left oblique—trot.* The command MARCH is repeated by the same chiefs; and when the oblique movement is commenced, they repeat the command, *Guide right.* Each chief commands: FORWARD, as soon as his section has obliqued sufficiently to the left, and, *Walk,* in time to command MARCH, as it arrives on the line.

When the battery is marching in column at a trot, the movement is executed according to the same principles. In this case the captain does not command *Trot*; and the chief of the leading section commands: *Walk—MARCH,* successively after the first and second commands of the captain. The chiefs of the other sections give the same commands as their sections arrive on the line.

The movement is executed so as to gain ground to the right, according to the same principles and by inverse means.

TO FORM DOUBLE COLUMN ON THE CENTRE SECTION.

165. The battery being in line at a halt, to form double column on the centre section, the captain commands :

1. *Double column on the centre.*
2. MARCH.
3. *Guide right (or left.)*

(Pl. 32.) At the first command, the chief of the centre section commands: *Section—forward*; the chief of the

right section: *Section—left oblique*; and the chief of the left section: *Section—right oblique*. At the command MARCH, repeated by the chief of the centre section, that section marches to the front, and its chief repeats the command for the guide.

When the wheel horses in the rear rank of the centre section have passed the leaders in the front rank of the other sections, the chiefs of those sections repeat the command MARCH, and the sections commence the oblique.

When the piece nearest the column is about entering it, in each of these sections, the chief of the right section commands: *By the left—break section—MARCH*; and the chief of the left: *By the right—break section—MARCH*. The right and left sections, without change of gait, then form into columns of pieces in rear of the right and left carriages of the centre section.

The chiefs of the flank sections are careful to make their pieces enter the column at the proper time. And when the column is formed they place themselves outside of it, four yards from the centres of their respective sections.

The chief of the line of caissons follows the movement, sees that his carriages do not enter the column too soon, and, when the column is formed, places himself four yards in rear of its centre.

When the battery is marching at a walk, to form the double column at the same gait, the captain commands:

1. *Double column on the centre.*
2. MARCH.
3. *Guide right (or left.)*

The chief of the centre section repeats the command for the guide and the section continues to advance.

At the command MARCH, the other sections are halted by the command, *Section—HALT*, from their chiefs. They are afterwards formed into column by the commands and means prescribed for forming double column from a halt.

When the battery is marching at a trot, the double column is formed according to the same principles. In

this case the flank sections pass to a walk, instead of halting as before, and resume the trot to oblique and enter the column. The commands from their chiefs are: *Walk—MARCH—Section—left (or right) oblique—trot—MARCH*, and, *By the left (or right)—break section—MARCH*.

When the battery is marching at a walk, to form the double column at a trot, the captain commands :

1. *Double column on the centre—trot.*
2. **MARCH.**
3. *Guide right (or left.)*

At the first command, the chief of the centre section commands: *Trot*. At the second, which he repeats, the section moves forward at a moderate trot, and he repeats the command for the guide.

The flank sections continue to walk until the centre has advanced sufficiently to allow them to oblique, and are then formed into column as already prescribed ; their chiefs commanding, *Section—left (or right) oblique—trot—MARCH*, and, *By the left (or right)—break section—MARCH*.

To form the double column with a battery of four pieces, the captain gives the same commands as with a battery of six. The right section is broken into column of pieces by the left, and the left section by the right, according to the principles prescribed in No. 151. The chiefs of sections place themselves on the outer flanks of the column, abreast the leading drivers of the leading carriages. The senior chief repeats the command for the guide, and gives such other commands as are required for the head of the column ; the leading carriages moving as a section for the time being.

TO DEPLOY THE DOUBLE COLUMN INTO LINE TO
THE FRONT.

166. The battery being in double column at a halt, to form it into line to the front, the captain commands :

1. *Forward into line.*
2. **MARCH.**
3. **FRONT.**

(Pl. 33.) At the first command, the chief of the centre section commands: *Section—forward*; the chief of the right section: *Section into line—right oblique*; and the chief of the left section: *Section into line—left oblique*. At the command MARCH, repeated by these chiefs, the centre section advances five yards and its chief commands: *Section—HALT—Right (or left)—DRESS*.

The flank sections oblique to the right and left; and as their pieces arrive in rear of their proper places on the line, they move forward, halt, and dress towards the centre without command.

As soon as the battery is aligned the captain commands: FRONT.

When the column is marching, the movement is executed in the same manner. In this case the chief of the centre section does not command, *Section—forward—MARCH*; but halts and aligns his section after advancing five yards.

167. When the column is marching at a trot, to deploy it into line to the front at the same gait, without discontinuing the march, the captain commands:

1. *Form line advancing.*
2. MARCH.
3. *Guide right (or left.)*

At the first command, the chief of the centre section commands: *Walk*; the chief of the right section: *Section into line—right oblique*; and the chief of the left section: *Section into line—left oblique*. At the command MARCH, repeated by these chiefs, the centre section slackens its gait to a walk, and the flank sections deploy. As each piece arrives upon the line, its gait is changed to a walk without command. The movement is executed as in the preceding cases; but when the line is formed it continues to advance; the captain commanding, *Guide right (or left,)* which command is repeated by the chiefs of sections.

When the column is marching at a walk, to deploy it into line to the front at a trot, without discontinuing the march, the captain commands:

To deploy the double column into line to the front.

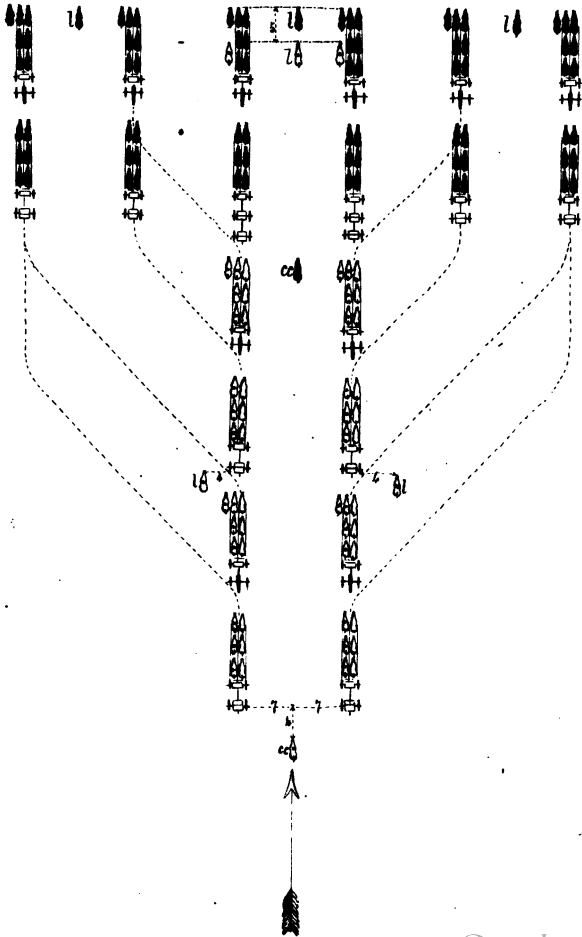

1. *Form line advancing—trot.*
2. MARCH.
3. *Guide right (or left.)*

At the first command, the chief of the right section commands: *Section into line—right oblique—trot*; and the chief of the left section: *Section into line—left oblique—trot*. At the command MARCH, repeated by these chiefs, the flank sections deploy at a trot; the centre section continues to march at a walk; and, the line having been formed as in the preceding case, the captain gives the command for the guide.

When the battery consists of four pieces, the double column is deployed into line to the front by the same commands from the captain as when it consists of six. The chiefs of sections give the same commands as in the other case, and then their sections are formed as in No. 140. When the line is to be halted, as in forming *forward into line*, the senior chief commands: HALT—*Right (or left)—DRESS*, as soon as the leading carriages have advanced five yards; and the alignment is made upon the central carriages.

TO FORM THE DOUBLE COLUMN INTO LINE TO THE RIGHT OR LEFT.

168. The battery being in double column at a halt, to form it into line to the right, the captain commands:

1. *To and on the right into line.*
2. MARCH.
3. FRONT.

At the first command, the chief of the leading section commands: *Section—right wheel*; and the other chiefs of sections: *Forward*. At the second, repeated by those chiefs, the leading section wheels to the right and is established on the line as in No. 157. The other pieces advance under the direction of their chiefs and of the chiefs of sections, wheel to the right in succession as they arrive opposite their places, establish themselves on the line, and dress upon the pieces already aligned. When the alignment is completed the captain commands: FRONT.

When the column is marching, the line is formed to the right in the same manner, except that the chiefs of the flank sections omit the commands, *Forward—MARCH*.

The line is formed to the left according to the same principles and by inverse means.

When the battery consists of four pieces, the double column is deployed into line to the right or left by the same commands from the captain, as when it consists of six. In this case the leading pieces are wheeled to the right or left, as a section, and established on the line as in No. 157. For this purpose the senior chief of section commands: *Right (or left) wheel—MARCH—FORWARD—Guide right—(or left)—HALT—Right (or left)—DRESS*. The other pieces move forward, wheel in succession as they arrive opposite their places, and form on the line as already described.

TO ADVANCE IN LINE.

169. The battery being in line at a halt, to cause it to advance, the captain indicates to the guide the points on which he is to march, and commands:

1. *Battery—forward.*
2. **MARCH.**
3. *Guide right (or left.)*

The commands, *Forward—MARCH—Guide right (or left,)* are repeated by the chiefs of sections. At the command **MARCH**, all the carriages move forward at a walk, and the chiefs of sections preserve the alignment towards that chief of carriage who serves as *guide of the line*. The guide marches steadily in the given direction, and the chiefs of carriages regulate their intervals and alignment by him.

The carriages of the rear rank follow those in front at their appropriate distance of two yards. The chief of the line of caissons superintends the march of the rear rank of carriages, and moves wherever his presence may be necessary for that purpose.

In horse artillery the detachments preserve their alignments, and follow their pieces at the proper distance. They are sometimes upon the flanks as pointed out in No. 124.

TO HALT THE BATTERY AND ALIGN IT.

170. When the battery is marching in line, to halt and align it, the captain commands :

1. *Battery*—HALT.
2. *Right (or left)*—DRESS.
3. FRONT.

The commands, HALT—*Right (or left)*—DRESS, are repeated by the chiefs of sections. At the first command, the carriages and detachments halt, and at the second align themselves by the right (or left) in their respective ranks; the carriages dressing by the drivers of their wheel horses. The carriages are placed as squarely on the line as possible without opening or closing the intervals. The captain superintends the alignment of the front rank of carriages, and the chief of the line of caissons that of the rear; each placing himself for that purpose on the flank of the guide. When the Battery is aligned the captain commands: FRONT.

When the battery is halted, if it cannot be aligned by slight movements, the captain causes one or two carriages from one of the flanks or centre to advance four yards, or to a greater distance if necessary, and then causes the alignment to be made by the right, left, or centre, by the command, *Right, Left, or, On the centre*—DRESS. At this command, the carriages and detachments move forward and align themselves according to the principles just explained; the drivers halting a little in rear of the line, and dressing forward so as to place the carriages as squarely upon it as possible.

CHANGES OF GAIT.

171. When the battery is marching in line, the changes of gait are effected by the commands and means prescribed in No. 139.

TO MARCH BY A FLANK.

172. (Pls. 34. & 35.) The battery being in line, in march or at a halt, to cause it to move in the direction of one of its flanks, the captain commands :

1. *Battery—by the right (or left) flank.*
2. MARCH.

And the movement is executed as prescribed in No. 145.

OBLIQUE MARCH.

173. (Pls. 36 & 37.) The battery being in line, in march or at a halt, to gain ground to the front and towards one of the flanks, and afterwards resume the direct march, the captain commands: *Battery—right (or left) oblique, &c.* as in No. 146. The movement is executed as described in that number.

PASSAGE OF CARRIAGES IN LINE.

174. When the battery is in line, the passage of carriages is executed by the commands and means prescribed in No. 147.

ABOUT IN LINE.

175. When the battery is in line, the about is executed by the commands and means prescribed in No. 148; substituting the word *battery* for *column*.

COUNTERMARCH IN LINE.

176. The countermarch of a battery in line is executed by the commands and means prescribed in No. 149; substituting the word *battery* for *column*.

TO CHANGE DIRECTION IN LINE.

177. The battery being in line at a halt, to wheel it to the right, the captain commands :

Flank march.
Foot Artillery.

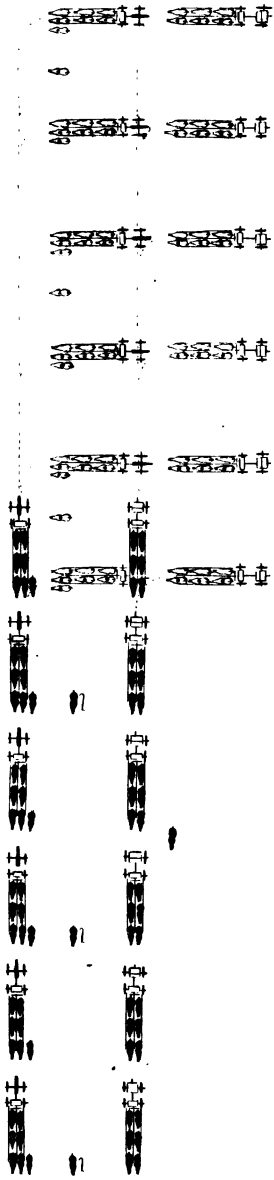

a

Flank march.
Horse Artillery.

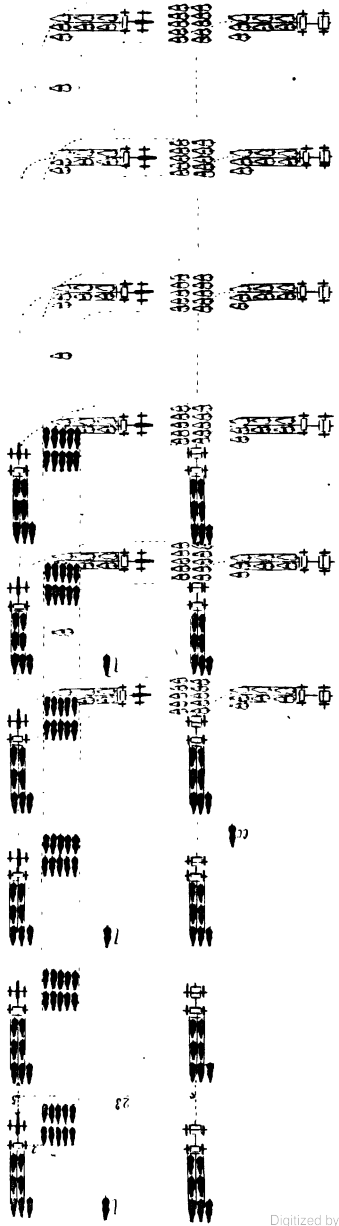

The oblique march:

Foot & Artillery:

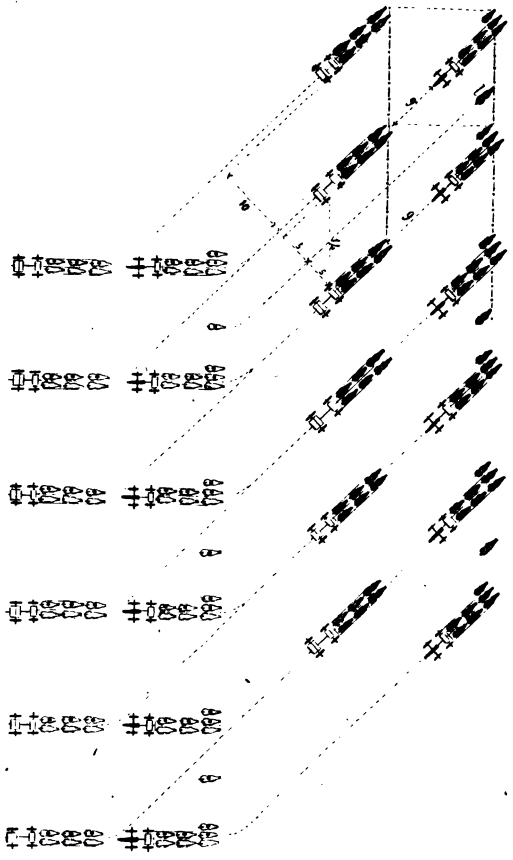

The oblique march.
Horse Artillery

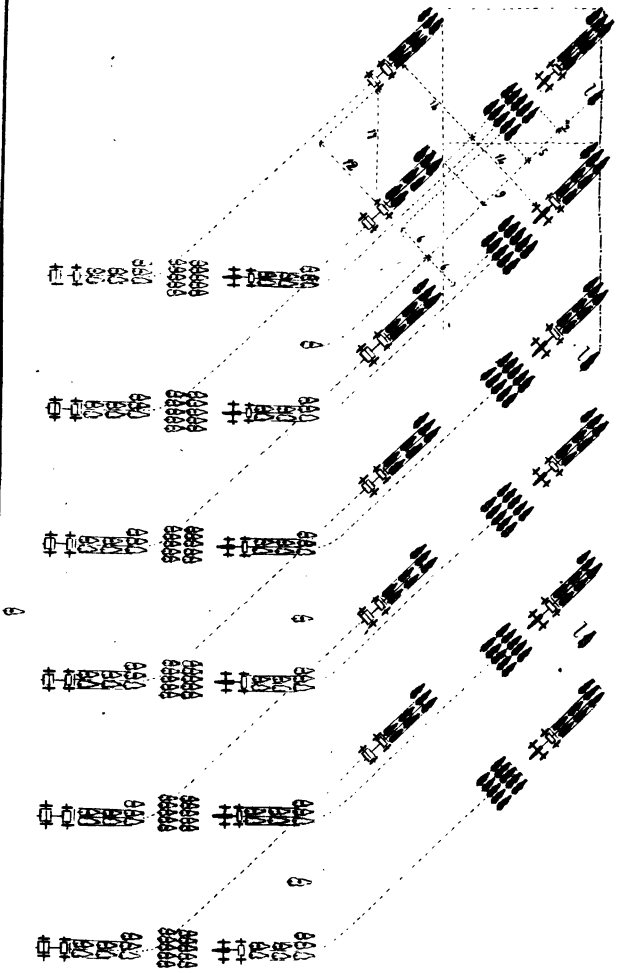

Change of direction in line.

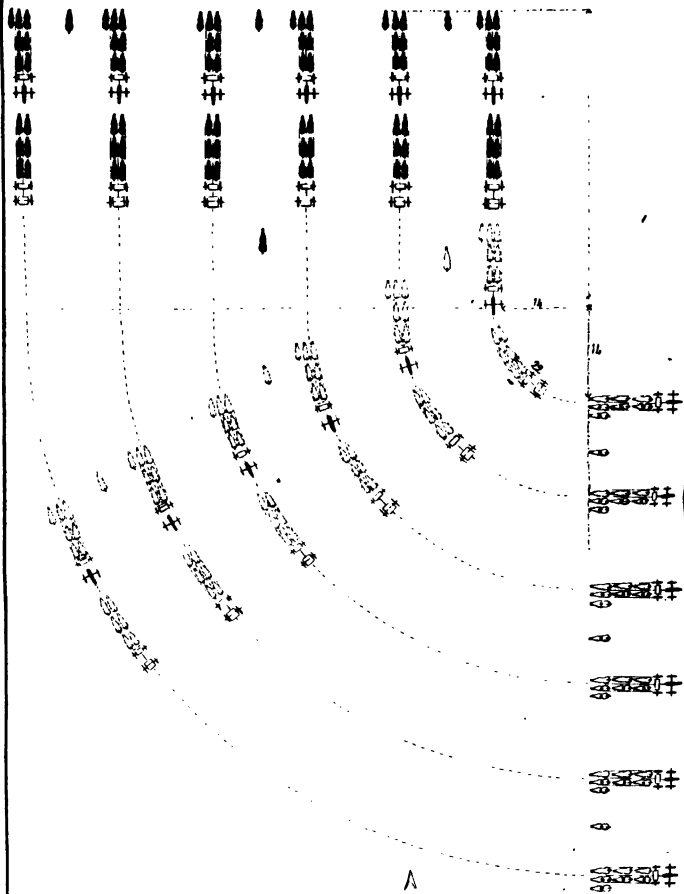

1. *Battery—right wheel.*
2. MARCH.
3. FORWARD.
4. *Battery—HALT.*
5. *Right—DRESS.*
6. FRONT.

The commands, *Right wheel—MARCH—FORWARD—HALT—Right—DRESS*, are repeated by the chiefs of sections.

(Pl. 38.) At the command MARCH, the pivot carriage moves at a walk, and describes a quadrant (22 yards) of a circle, whose radius is 14 yards. The other carriages move at a trot and preserve their intervals from the pivot. They regulate their gaits according to their distances from the pivot, so as to remain as short a time as possible in rear of the line, without urging their horses injuriously, and so as to arrive upon it in succession. The carriages of the rear rank follow at the proper distance in the tracks of those in front.

At the command FORWARD, which is given when the leading pivot carriage has described its arc of 22 yards, that carriage moves direct to the front; and when the rear pivot carriage is in the new direction, the captain commands: *Battery—HALT—Right—DRESS*. The commands, *FORWARD—HALT—Right—DRESS*, are repeated by the chief of the right section immediately after the captain; and by the other chiefs in time to be applicable to their sections; the pivot carriages halting at the command HALT, and the others halting and dressing towards the pivot as they arrive in succession on the line.

When the battery is aligned, the captain commands: FRONT.

The battery is wheeled to the left according to the same principles and by inverse means.

178. When the battery is at a halt or marching in line, to wheel it to the right and continue the march, the captain commands:

1. *Battery—right wheel.*
2. MARCH.
3. FORWARD.

The movement is executed as already described, except that the pivot carriage, after wheeling, continues to march in the new direction, and the others conform to its gait and direction as they arrive on the line.

The direction is changed to the left according to the same principles and by inverse means.

TO CLOSE INTERVALS IN LINE.

179. When the battery is marching in line at a walk or trot, to diminish its intervals, the captain commands :

1. *On right (or left) piece, of ——— section, to ——— yards—close intervals.*

2. MARCH.

(Pl. 39.) The chief of the section designated repeats the command, *On right (or left) piece, to ——— yards—close intervals*; and the other chiefs of sections command: *Right (or left) to ——— yards—close intervals*. At the command MARCH, repeated by the same chiefs, the piece designated as the one of direction moves forward at a walk, and the others oblique towards it at a trot. Each obliquing carriage regulates its march by the one next towards the carriage of direction, and, after closing to the prescribed interval, moves forward on the alignment of the directing carriage and slackens the gait to a walk.

As soon as the intervals are closed, the command for the guide is renewed by the captain, and repeated by the chiefs of sections.

When the intervals are to be closed towards one of the flanks, the captain commands :

1. *On right (or left) piece, to ——— yards—close intervals.*

2. MARCH.

ABOUT OR COUNTERMARCH WITH DIMINISHED INTERVALS.

180. The battery being in line with diminished intervals, in march or at a halt, to execute an about or countermarch, the captain commands :

Trochus interius

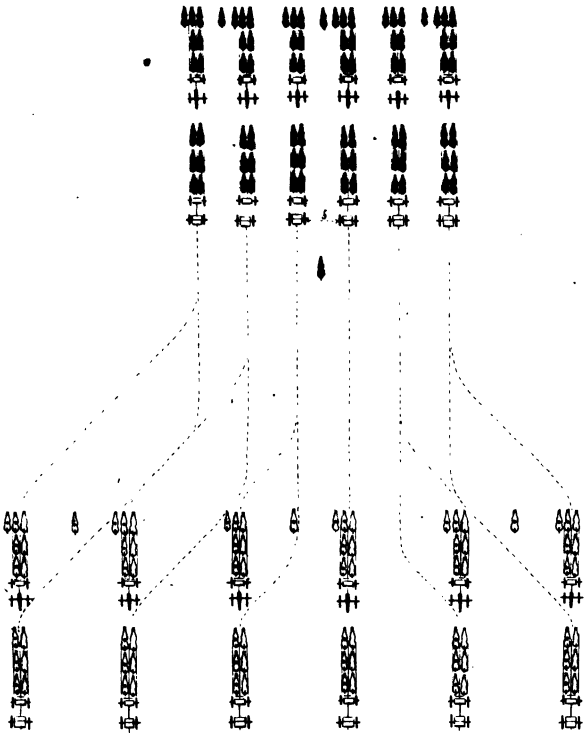

To resume intervals.

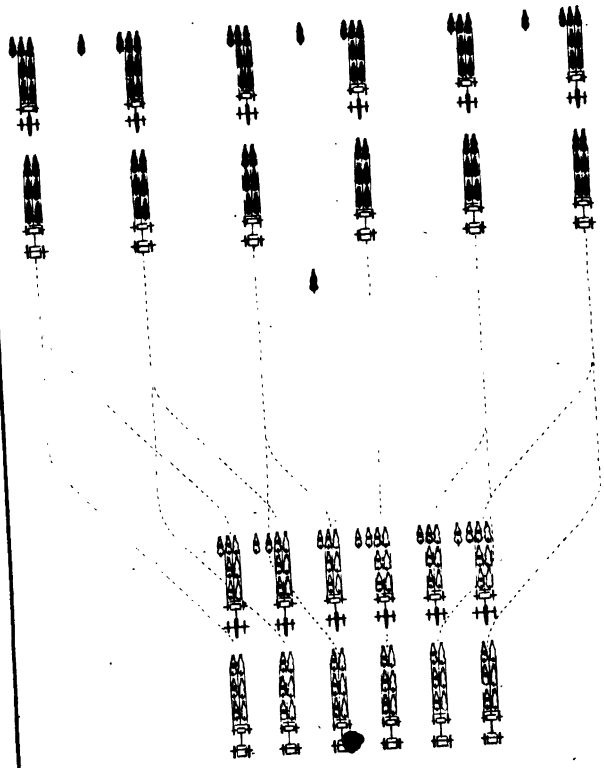

1. *Pieces and caissons—left about, (or countermarch.)*
2. *Right pieces forward, (or right pieces forward—trot.)*
3. MARCH.

The chiefs of sections repeat these commands. At the second, the right carriages of each section move forward, and as soon as they are disengaged from the line, the captain commands: MARCH. All the carriages execute the required movement at this command, with the gait corresponding to that of the carriages in front.

In regard to the change of gait, these movements are executed according to the principles of No. 147, in order that the right carriages may move out of the line and return to it again at the completion of the movement.

TO RESUME INTERVALS.

181. When the battery is marching in line with diminished intervals, to cause the regular intervals to be resumed, the captain commands:

1. *On right (or left) piece of ——— section—full intervals.*
2. MARCH.

(Pl. 40.) The chief of the section designated repeats the command: *On right (or left) piece—full interval*; and the other chiefs of sections command: *From the right (or left)—full intervals.*

At the command MARCH, repeated by the chiefs of sections, the carriage of direction in each rank continues to march to the front, and the others oblique from it at an increased gait to regain their intervals. Each carriage regulates its march by the one adjoining towards the carriage of direction, and, when the interval is regained, moves forward on the alignment and resumes its gait.

As soon as the movement is completed, the command for the guide is renewed by the captain, and repeated by the chiefs of sections.

When the intervals are to be resumed from one of the flanks, the captain commands :

1. *On right (or left) piece—full intervals.*
2. MARCH.

PASSAGE OF OBSTACLES.

182. When the battery is marching in line, to pass an obstacle which presents itself in front of one of the sections, the captain commands :

1. ——— *Section.*
2. OBSTACLE.

At the command **OBSTACLE**, the chief of the section designated observes the obstacle, and gives the necessary commands for closing on one of the adjoining sections, removing from it, breaking his section, or halting it and forming in column in rear of one of the adjoining sections. The section generally resumes the regular march by means the inverse of those used for passing the obstacle. It resumes its place at an increased gait, and by the commands, *Section into line—MARCH*, from its chief.

The passage of defiles is nothing more than the passage of obstacles, which requires the line to be broken into column of sections, by one of the manœuvres prescribed for passing from the order in line to the order in column. When it becomes necessary to break the sections, they should be formed again in succession by their chiefs as soon as the ground will permit.

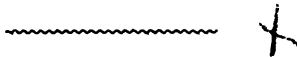

FORMATIONS IN BATTERY.

IN LINE WITH PIECES IN FRONT TO FORM IN BATTERY TO THE FRONT.

183. When the battery is in line at a halt, with the pieces in front, to form in battery to the front, the captain commands :

In line, with caissons in front, to form in battery to the front.

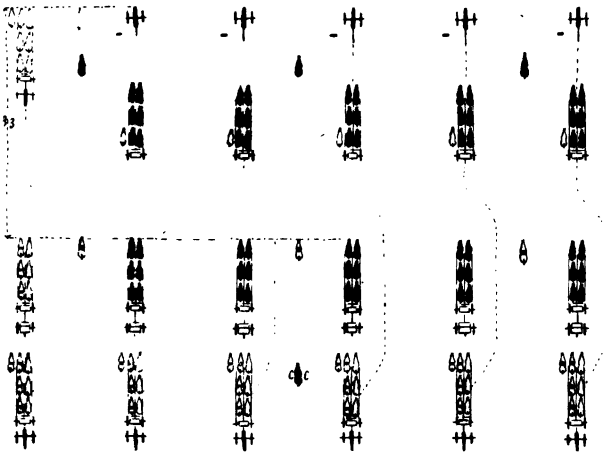

In line, with pieces in front, to form in battery to the front.

Foot Artillery:

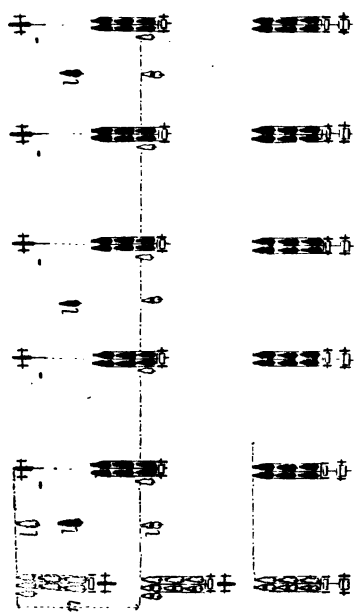

1. IN BATTERY.
2. *Guide left.*
3. MARCH.

(Pl. 41.) These commands are repeated by the chiefs of sections. At the command IN BATTERY, the caissons stand fast, and the pieces advance. The intervals and alignment are preserved, and the chiefs of pieces and sections march at their places in line. At the command MARCH, which is given as soon as they have advanced 17 yards, the chiefs of pieces and sections halt, and the pieces execute an about. As soon as the about is completed, the pieces are halted, unlimbered, and prepared for firing; the limbers being taken to their places in battery by an about, (No. 127.)

When the cannoneers are marching by the sides of their pieces, they halt at the command MARCH, allow their pieces to pass them, change sides, and move forward to the posts they are to occupy, when their pieces have completed the about. They are not required to observe any particular order during this movement.

When the cannoneers are mounted on the ammunition chests, those on the caissons dismount and run to their posts at the command IN BATTERY. Those on the pieces dismount after the about.

The chiefs of pieces and sections, take their posts in battery, as soon as the formation is completed, (No. 127.)

In horse artillery, the movement is executed in the same manner, and by the same commands. But the pieces advance only ten yards before executing the about. The horses of the detachments do not advance. But at the command IN BATTERY, the cannoneers dismount and run to their posts, (No. 10.)

After the formation the captain rectifies the alignment if necessary.

When the battery is marching in line with the pieces in front, it is formed in battery to the front, according to the same principles, and by the commands, IN BATTERY—MARCH. The caissons halt at the command IN BAT-

TERY; and in horse artillery the detachments do the same; the cannoneers dismounting and running to their posts.

TO FORM IN BATTERY TO THE FRONT BY THROWING THE CAISSONS TO THE REAR.

184. When the battery is in line at a halt, with the pieces in front, to form in battery to the front by throwing the caissons to the rear, the captain commands :

ACTION FRONT.

At this command, repeated by the chiefs of sections, the pieces are unlimbered and wheeled about by hand; the limbers reversing to the left at the same time, and taking their places in battery, as described in the school of the piece, (No. 31.) The caissons reverse to the left, move to the rear, reverse again to the left, and take their places in battery, (No. 127.)

When the cannoneers are mounted on the ammunition chests, they dismount and run to their posts at the command **ACTION FRONT.**

In *horse artillery*, when this mode of coming into action is resorted to, the detachments move to the posts, belonging to their horses in battery, before dismounting, except when the number of horses is so small, that they may be led to the rear by the horse holders. In this case the captain commands: **DISMOUNT**; immediately after **ACTION FRONT.** When the detachments conduct their horses to the rear, they dismount without command from the captain.

The battery is generally in line at a halt when this mode of coming into action is resorted to. It may also be used in successive formations by giving the command **ACTION FRONT**, when a part of the battery has been halted on the line. But with bad ground or heavy pieces this mode of coming into action should not be used.

IN LINE WITH CAISSONS IN FRONT, TO FORM IN BATTERY TO THE FRONT.

185. When the battery is in line at a halt, with the caissons in front, to form in battery to the front, the captain commands :

In line, with various in part, to form in battery to the rear.

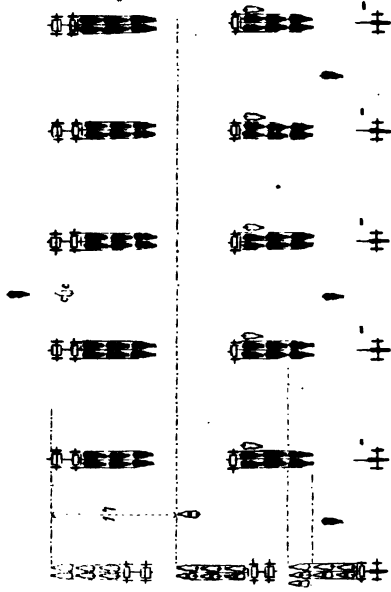

In line, with pieces in front, to form in battery to the rear.

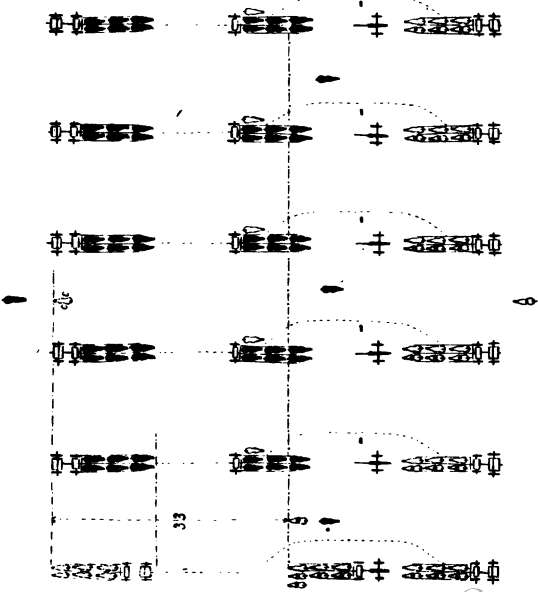

1. *Pieces pass your caissons.*
2. MARCH.
3. IN BATTERY.
4. *Guide left.*
5. MARCH.

(Pl. 41.) These commands are repeated by the chiefs of sections; the pieces pass their caissons as prescribed in Nos. 117 and 147; and at the command IN BATTERY, given as soon as the pieces have passed their caissons, the formation is executed as prescribed in No. 183.

In horse artillery, the command IN BATTERY is given when the detachments have passed the caissons.

When the battery is marching in line, with the caissons in front, it is formed in battery to the front according to the same principles, and by the commands, *Pieces pass your caissons* (or *pieces pass your caissons—trot*)—MARCH—IN BATTERY—*Guide left*—MARCH.

IN LINE WITH PIECES IN FRONT, TO FORM IN BATTERY TO THE REAR.

186. When the battery is in line at a halt, with the pieces in front, to form in battery to the rear the captain commands:

1. *Fire to the rear.*
2. *Caissons pass your pieces—trot.*
3. MARCH.
4. IN BATTERY.

(Pl. 42.) The three last commands are repeated by the chiefs of sections. At the third, the caissons pass their pieces at a brisk trot. And at the fourth, which is given as soon as the caissons have passed, the cannoneers unlimber and prepare for firing.

The caissons advance 17 yards beyond their pieces, execute an about together, and take their places in battery, (No. 127.)

When the cannoneers are mounted on the ammunition chests, the caissons advance 17 yards beyond their pieces, and then halt to allow the cannoneers to dismount before executing the about. As soon as the caissons halt, the

cannoneers dismount and run to their posts. When the battery is at a halt, as in the present case, it is considered better to dismount the cannoneers before commencing the movement. The chief of the line of caissons precedes the movement of his carriages, and places himself on the line to be occupied by their leaders, when the about is commenced. He takes his place in battery as soon as the about is completed, and the carriages are on the line.

The chiefs of pieces and sections take their places in battery, as soon as the formation is completed.

In horse artillery, at the command **IN BATTERY**, the detachments incline to the right, pass their pieces at a brisk trot, and take their places in battery by a left about. The cannoneers then dismount, run to their posts, unlimber, and prepare for firing.

When the battery is marching in line, with the pieces in front, the formation in battery to the rear is executed according to the same principles and by the same commands. At the command **IN BATTERY**, which is given as soon as the caissons have passed their pieces, the latter halt, the detachments in horse artillery pass them, and the movement is completed as already described.

IN LINE WITH CAISSONS IN FRONT, TO FORM IN BATTERY TO THE REAR.

187. When the battery is in line at a halt, with the caissons in front, to form in battery to the rear, the captain commands:

1. *Fire to the rear.*
2. **IN BATTERY.**

(Pl. 42.) At the command **IN BATTERY**, which is repeated by the chiefs of sections, the cannoneers unlimber and prepare for firing.

The chiefs of pieces and sections take their places in battery.

The caissons move at a brisk trot and take their places in battery, under the superintendence of their chief, as prescribed in No. 186.

In battery to form forward into line with caissons in front by limbering to the rear.



In battery to form forward into line, with pieces in front, by limbering to the rear.

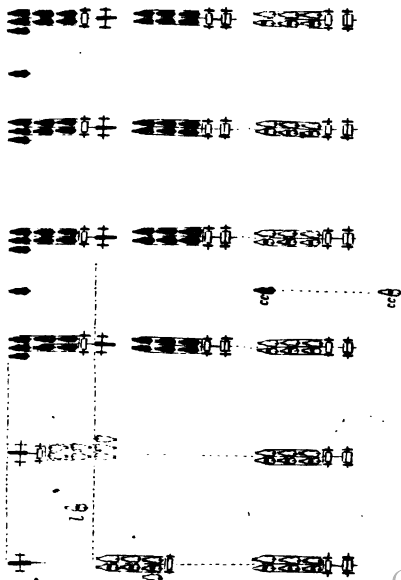

In horse artillery, at the command **IN BATTERY**, the detachments pass their pieces at a trot, move to their places in battery, dismount, and run to their posts, as prescribed in No. 186.

When the battery is marching in line, with the caissons in front, the formation in battery to the rear, is executed according to the same principles and by the same commands.

IN BATTERY, TO FORM IN LINE TO THE FRONT.

188. Being in battery, to form in line to the front with the caissons in rear, the captain commands :

LIMBER TO THE FRONT.

This command is repeated by the chiefs of sections and the pieces are limbered as described in No. 28; the caissons closing at the same time to the proper distance without further command.

When the captain wishes to place the caissons in front, he commands: **LIMBER TO THE FRONT**; and while the pieces are limbering, *Caissons pass your pieces—trot—MARCH.* The caissons pass and halt in front of their pieces; or, if the captain wishes the battery to advance, he commands: **FORWARD—Guide right (or left,)** as the caissons are completing the passage, and the battery moves forward at a walk, as prescribed in No. 174.

In horse artillery, when the pieces are limbered to the front, the horse holders advance within two yards of their pieces; and there the cannoneers mount.

When the pieces cannot be wheeled about by hand, the captain commands: **LIMBER TO THE REAR**; and when this is executed, if he wishes to retain the pieces in front, he commands :

1. *Pieces left about—caissons forward.*
2. **MARCH.**
3. *Battery—HALT.*

(Pl. 43.) The command **LIMBER TO THE REAR** is repeated by the chiefs of sections, and the pieces are limbered as prescribed in No. 30. The first and second

commands are also repeated by the chiefs of sections, and the pieces execute the about; the caissons closing at the same time to two yards. The third command is given as soon as the about is completed, and the word **HALT** being repeated by the chiefs of sections, the pieces halt and place themselves squarely on the line.

The captain rectifies the alignment, if necessary, and commands: **FRONT**.

When the battery is to advance immediately, the captain commands: **FORWARD**—*Guide right (or left,)* instead of *Battery*—**HALT**; and the caissons close on the march.

(Pl. 43.) When the captain wishes to place the caissons in front, he may cause the pieces to be limbered to the rear as before, and command:

1. *Caissons pass your pieces—trot—pieces left about.*
2. **MARCH.**
3. *Battery*—**HALT**, or **FORWARD**—*Guide right (or left.)*

These commands are repeated and executed as already prescribed; the pieces executing the about as soon as the ground has been unmasked by the caissons, and the battery halting or advancing, as soon as the passage is completed.

In horse artillery, when the pieces are limbered to the rear, the cannoneers run to their horses, mount, and re-join their pieces.

IN BATTERY TO FORM IN LINE TO THE REAR.

189. When in battery, to form in line to the rear, the captain causes the pieces to be limbered to the rear; and then, if he wishes to place the caissons in front, commands:

1. *Caissons left about—pieces forward.*
2. **MARCH.**
3. *Battery*—**HALT**, or **FORWARD**—*Guide right (or left.)*

(Pl. 44.) The two first commands are repeated by the chiefs of sections; the caissons execute the about; and the pieces close to their proper distance. The third command, which is given at the moment the about is

In battery, to form in line to the rear, with pieces in front.

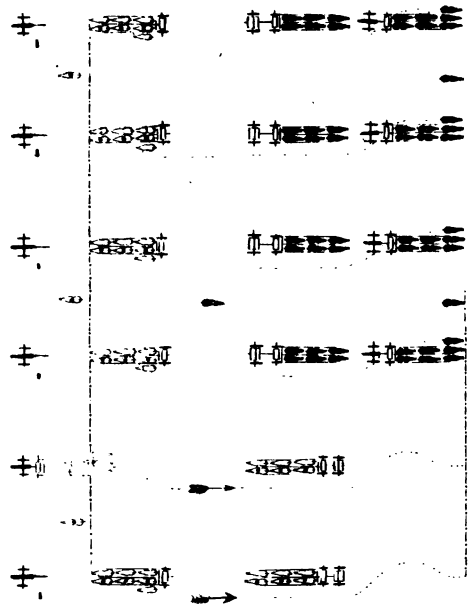

In battery, to form in line to the rear, with caissons in front.

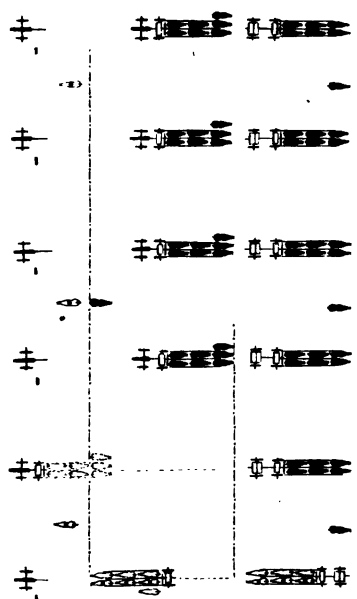

is finished, is repeated and executed as prescribed.

The captain rectifies the alignment if necessary, and commands: **FRONT.**

In horse artillery, the detachments oblique to the left to facilitate the movement of the caissons. And then if the battery halts, they place themselves at once in rear of their pieces; or if it advances, they wait and do the same by wheeling to the right as they pass.

If the formation in line to the rear is to be executed by placing the pieces in front, the captain, after causing the pieces to be limbered to the rear, commands:

1. *Pieces pass your caissons—caissons left about.*
2. **MARCH.**
3. *Battery—HALT, or FORWARD—Guide right (or left.)*

(Pl. 44.) The two first commands are repeated by the chiefs of sections; the pieces pass their caissons; and the caissons execute the about as soon as the ground is unmasked. The third command is repeated and executed according to the principles prescribed in No. 138.

The captain rectifies the alignment if necessary, and commands: **FRONT.**

In horse artillery, the detachments place themselves behind their pieces as soon as they are passed by them.

In forming line to the rear, either with pieces or caissons in front, the caissons may be placed at once in front of their pieces for greater convenience in mounting the cannoneers. For this purpose, as soon as the captain has commanded: **LIMBER TO THE REAR**, he commands:

1. *Caissons in front of your pieces (or caissons in front of your pieces—trot.)*
2. **MARCH.**

These commands are repeated by the chiefs of sections; and while the pieces are limbering, the caissons oblique to the right, move forward near the middle of the interval between the leaders of the pieces, place themselves in front of them by two successive wheels to the left, and halt.

In horse artillery, when the caissons are ordered to the front of their pieces, the horse holders oblique to the

left at the command MARCH, and halt between the leading drivers of the pieces. As soon as the cannoneers are mounted the detachments take their posts in rear of their pieces.

IN COLUMN WITH PIECES IN FRONT, TO FORM IN BATTERY TO THE FRONT.

190. When the battery is in column at a halt, with the pieces in front, to form in battery to the front by gaining ground to the left, the captain commands :

1. *Forward into battery—left oblique.*
2. MARCH.
3. *Guide right.*

(Pl. 45.) At the first command, the chief of the leading section commands : *Section—forward* ; and these of the other sections : *Section—left oblique*. The chief of the line of caissons moves quickly to the right of the leading section, to cause the caissons to halt at the proper time and to superintend their alignment. At the command MARCH, repeated by the chiefs of sections, the movement is executed as prescribed in No. 154, for forming line to the front. But as each section arrives on the line, instead of halting, its chief forms it in battery to the front by the commands, IN BATTERY—MARCH, which are executed as prescribed in No. 183.

The formation in battery to the front, by gaining ground to the right, is executed according to the same principles and by inverse means. The commands are : *Forward into battery—right oblique—MARCH—Guide left.*

When the battery is marching in column, it is formed in battery to the front by applying the principles of Nos. 154 and 183.

IN COLUMN WITH CAISSONS IN FRONT, TO FORM IN BATTERY TO THE FRONT.

191. When the battery is in column at a halt, with the caissons in front, to form in battery to the front by gaining ground to the left, the captain commands :

In column, with pieces in front, to form in battery to the front.

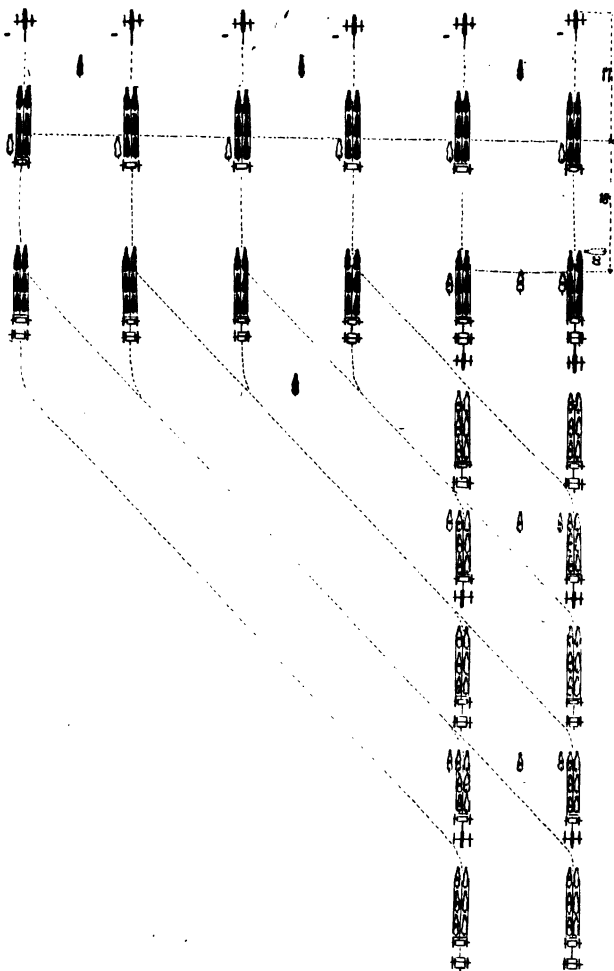

In column, with caissons in front, to form in battery to the front.

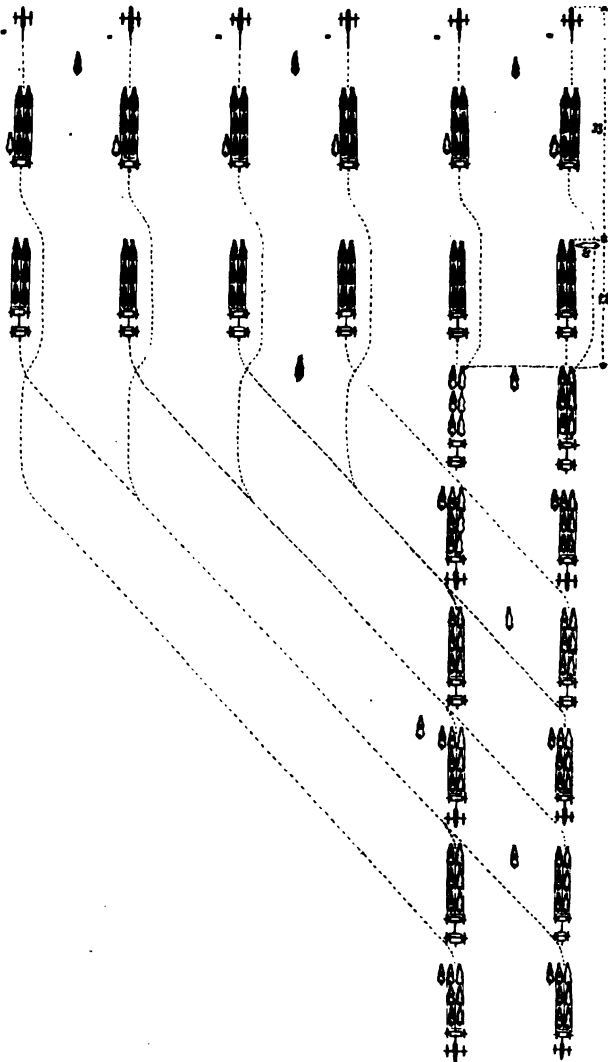

In column, with pieces in front, to form in battery to the rear.

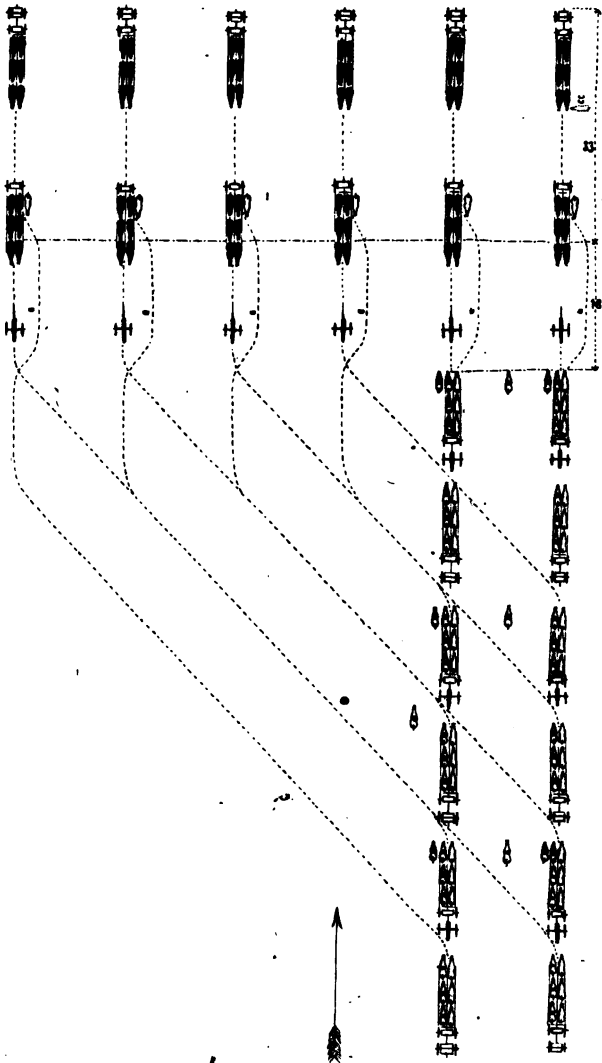

1. *Forward into battery—left oblique.*
2. MARCH.
3. *Guide right.*

(Pl. 46.) At the first command, the chief of the leading section commands: *Section—forward*; and those of the other sections: *Section—left oblique*. The chief of the line of caissons moves quickly to the right of the leading section, to halt the caissons at the proper time and to superintend their alignment. At the command MARCH, repeated by the chiefs of sections, the movement is executed as prescribed in No. 154, for forming line to the front. But as each section arrives on the line, instead of halting, its chief forms it in battery to the front by the commands, *Pieces pass your caissons—MARCH—IN BATTERY—MARCH*, which will be executed as prescribed in No. 185.

The formation in battery to the front, 'by gaining ground to the right, is executed according to the same principles and by inverse means.

When the battery is marching in column, it is formed in battery to the front by applying the principles of Nos. 154 and 185.

IN COLUMN WITH PIECES IN FRONT, TO FORM IN BATTERY TO THE REAR.

192. When the battery is in column at a halt, with the pieces in front, to form in battery to the rear by gaining ground to the left, the captain commands:

1. *Into battery faced to the rear—left oblique.*
2. MARCH.
3. *Guide right.*

(Pl. 47.) At the first command, the chief of the leading section commands: *Section—forward*; and those of the other sections: *Section—left oblique*. The chief of the line of caissons goes to the right of the leading section, to direct the about of the caissons, as prescribed in No. 186, and to superintend their alignment. At the command MARCH, repeated by the chiefs of sections, the

movement is executed as prescribed in No. 154, for forming line to the front. But as each section arrives on the line, instead of halting, its chief forms it in battery to the rear by the commands, *Caissons pass your pieces—trot—MARCH—IN BATTERY*, which are executed as prescribed in No. 186.

The formation in battery to the rear, by gaining ground to the right, is executed according to the same principles and by inverse means.

When the battery is marching in column, it is formed into battery to the rear by applying the principles of Nos. 154 and 186.

IN COLUMN WITH CAISSONS IN FRONT, TO FORM IN BATTERY TO THE REAR.

193. The battery being in column at a halt, with the caissons in front, to form in battery to the rear by gaining ground to the left, the captain commands :

1. *Into battery faced to the rear—left oblique.*
2. **MARCH.**
3. *Guide right.*

(Pl. 48.) At the first command, the chief of the leading section commands: *Section—forward*; and those of the other sections: *Section—left oblique*. The chief of the line of caissons goes to the right of the leading section, to direct the about of the caissons, as prescribed in No. 186, and to superintend their alignment. At the command **MARCH**, repeated by the chiefs of sections, the movement is executed as prescribed in No. 154, for forming line to the front. But as each section arrives on the line, instead of halting, its chief forms it into battery to the rear by the command **IN BATTERY**, which is executed as prescribed in No. 187.

The formation in battery to the rear, by gaining ground to the right, is executed according to the same principles and by inverse means.

When the battery is marching in column, it is formed into battery to the rear by applying the principles of Nos. 154 and 187.

In column, with caissons in front, to form in battery to the rear.

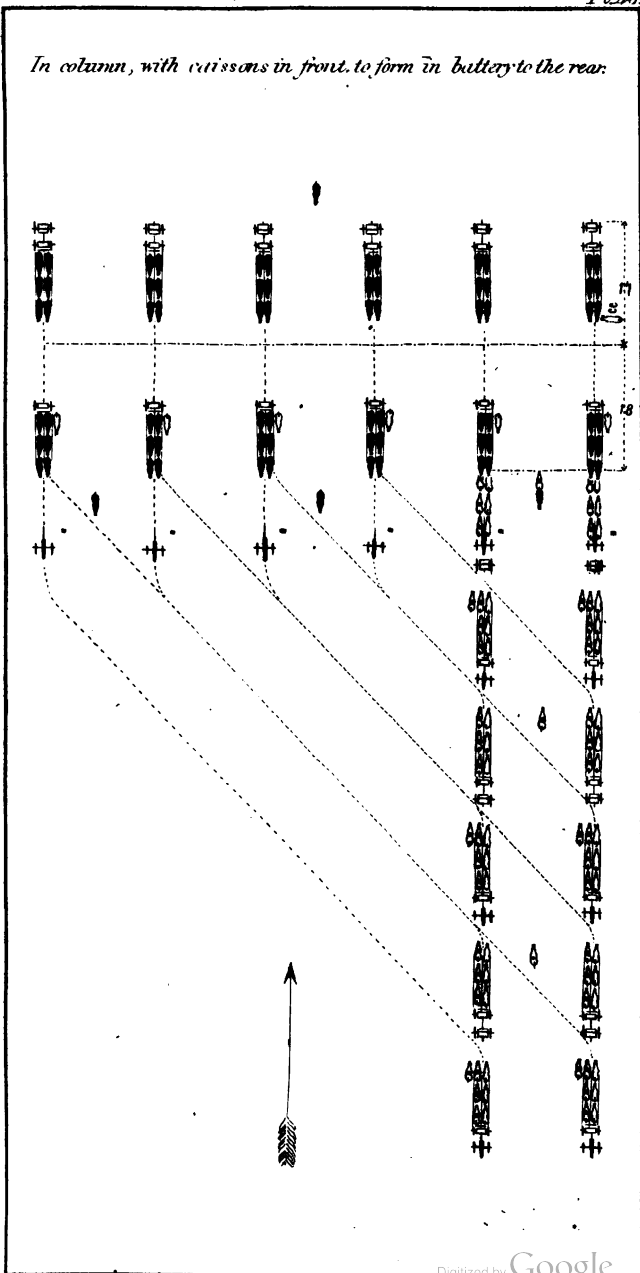

In column, with pieces in front, to form in battery to the left, gaining ground to the right.

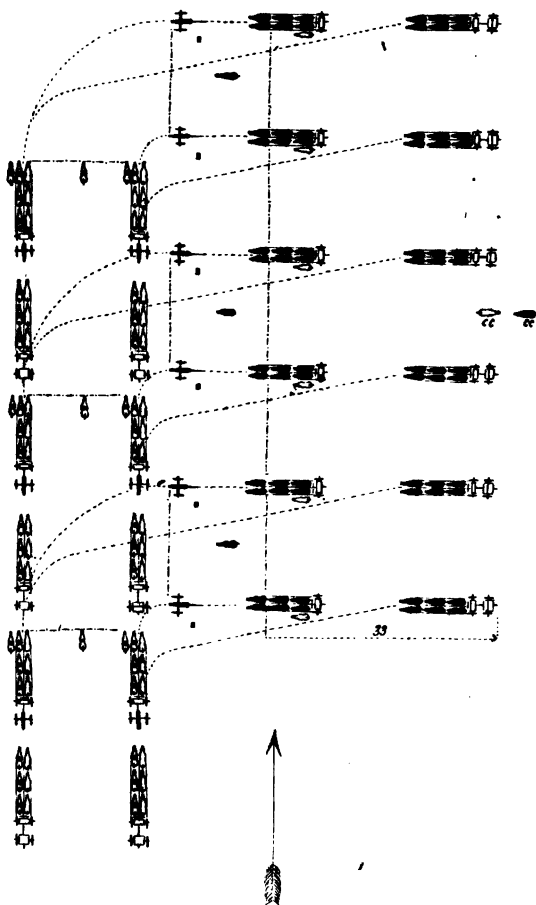

*In column, with pieces in front, to form in battery to the left,
gaining ground to the left.*

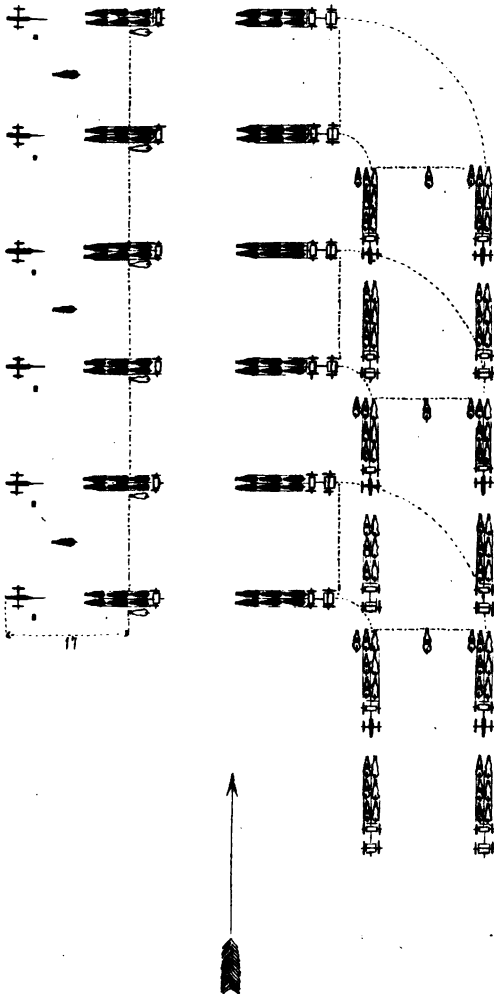

IN COLUMN WITH PIECES IN FRONT, TO FORM IN BATTERY TO THE RIGHT OR LEFT.

194. When the battery is in column, in march or at a halt, with the pieces in front, if the captain wishes to form it in battery to the left, by gaining ground to the right, he commands :

1. *Fire to the left—by section right wheel.*
2. MARCH.
3. *Caissons pass your pieces—trot.*
4. MARCH.
5. IN BATTERY.

(Pl. 49.) At the first command, the chiefs of sections command: *Section—right wheel*; and at the second, which they repeat, all the sections wheel to the right as prescribed in No. 120. The caissons follow their pieces at the proper distance.

At the commands, *Caissons pass your pieces—trot—MARCH*, which are given before the completion of the wheel, and repeated by the chiefs of sections, all the caissons pass their pieces at a trot.

At the command IN BATTERY, which is given and repeated in like manner as soon as the caissons have passed, and the pieces are square on the new line, all the sections form at once into battery to the rear as prescribed in No. 186.

When the captain wishes to form in battery to the left, by gaining ground to the left, he commands :

1. *Fire to the left—by section left wheel.*
2. MARCH.
3. IN BATTERY.
4. MARCH.

(Pl. 50.) At the first command, the chiefs of sections command: *Section left wheel*; and at the second, which they repeat, all the sections wheel at once to the left, as prescribed in No. 120.

At the command IN BATTERY, which is given and repeated as soon as the caissons have completed the wheel, all the sections form at once into battery to the front, as prescribed in No. 184.

The two formations in battery to the right, by gaining ground to the left or right, are executed according to the same principles and by inverse means. The commands are: *Fire to the right—by section left wheel—MARCH—Caissons pass your pieces—trot—MARCH—IN BATTERY*; (Pl. 51.) Or *Fire to the right—by section right wheel—MARCH—IN BATTERY—MARCH.*

IN COLUMN WITH CAISSONS IN FRONT, TO FORM IN BATTERY TO THE RIGHT OR LEFT.

195. When the battery is in column, in march or at a halt, with the caissons in front, to form it in battery to the left, by gaining ground to the right, the captain commands:

1. *Fire to the left—by section right wheel.*
2. MARCH.
3. IN BATTERY.

(Pl. 52.) At the first command, the chiefs of sections command: *Section—right wheel*; and at the second, which they repeat, the sections wheel at once to the right, and move to the front at the commands, FORWARD—*Guide right*, from their chiefs.

At the command IN BATTERY, which is given and repeated as soon as the pieces are square on the new line, all the sections form at once into battery to the rear, as prescribed in No. 187.

To form in battery to the left, by gaining ground to the left, the captain commands:

1. *Fire to the left—by section left wheel.*
2. MARCH.
3. *Pieces pass your caissons.*
4. MARCH.
5. IN BATTERY.
6. MARCH.

(Pl. 53.) At the first command, the chiefs of sections command: *Section—left wheel*; and at the second, which they repeat, the sections wheel at once to the left. The third and fourth commands are given and repeated just before the completion of the wheel; and the fifth is given

*In column, with pieces in front, to form in battery to the right,
gaining ground to the left.*

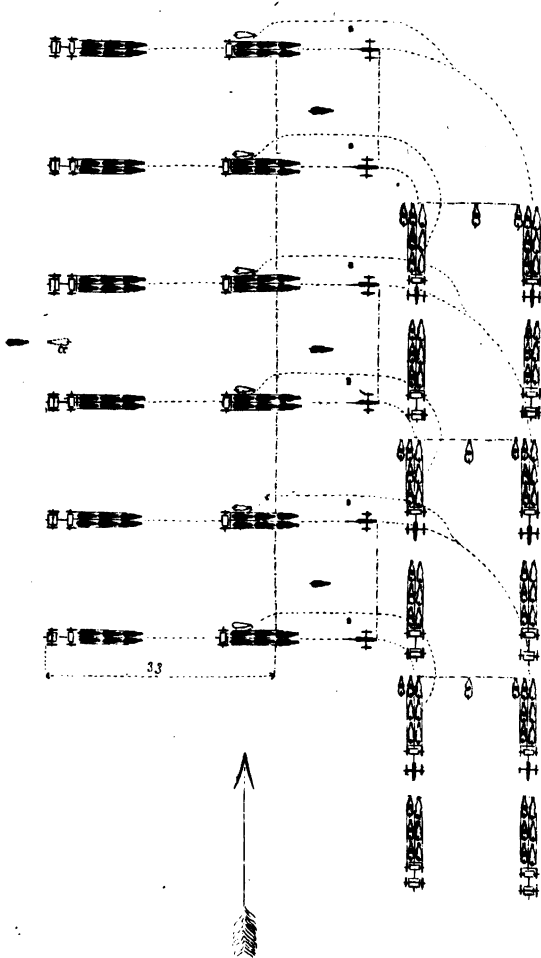

*In column, with caissons in front, to form in battery to the left,
gaining ground to the right.*

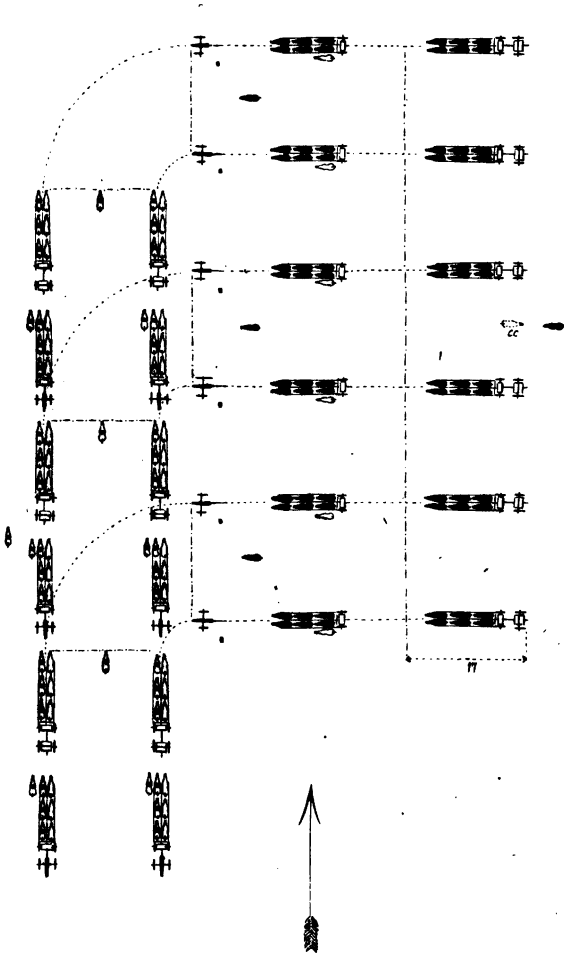

*In column, with caissons in front, to form in battery to the left,
gaining ground to the left.*

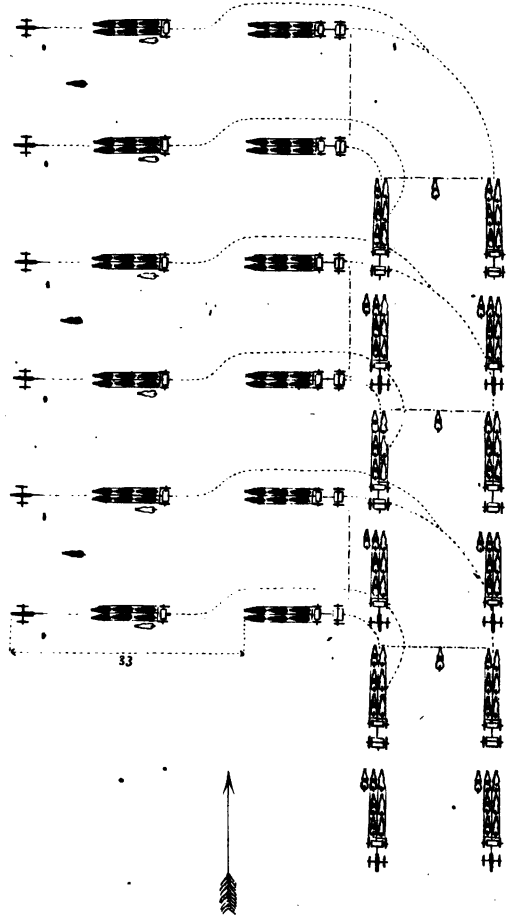

when the pieces have passed their caissons, and the latter are square upon the new line. The sections are then formed in battery to the front as prescribed in No. 183.

The formations in battery to the right, by gaining ground to the right or left, are executed according to the same principles and by inverse means. (Pl. 54.)

IN COLUMN WITH PIECES IN FRONT, TO FORM IN BATTERY ON THE RIGHT OR LEFT.

196. When the battery is marching in column with the pieces in front, to form in battery on the right, the captain commands :

1. *On the right into battery.*
2. MARCH.
3. *Guide right.*

At the first command, the chief of the leading section commands: *Section—right wheel*; and the chief of the line of caissons goes to that section, (No. 190.) At the command MARCH, repeated by the chief of the leading section, that section wheels to the right, and its chief conducts it to the line by the commands, FORWARD—*Guide right*, as prescribed in No. 157. And then, without halting, it is formed into battery to the front, as prescribed in No. 183, by the commands, IN BATTERY—MARCH, from its chief.

The other sections continue to advance; and as each arrives opposite its place in battery, after passing the one preceding it in the formation, it is formed into battery by its chief, by the commands, *Section—right wheel—MARCH—FORWARD—Guide right—IN BATTERY—MARCH*; the command IN BATTERY being given as the caissons arrive in line with those already established.

The formation in battery on the left is executed according to the same principles and by inverse means.

When the battery is in column at a halt, it is formed in battery on the right or left according to the same principles. In this case, the chiefs of the two rear sec-

tions command: *Section—forward*, immediately after the first command of the captain, and then repeat the commands, *MARCH—Guide right (or left.)*

IN COLUMN WITH CAISSONS IN FRONT, TO FORM IN BATTERY ON THE RIGHT OR LEFT.

197. When the battery is marching in column, with the caissons in front, to form in battery on the right, the captain commands:

1. *On the right into battery.*
2. *MARCH.*
3. *Guide right.*

At the first command, the chief of the leading section commands: *Section—right wheel*; and the chief of the line of caissons goes to that section, (No. 190.) At the command *MARCH*, repeated by the chief of the leading section, that section wheels to the right, and is conducted to the line, by the commands, *FORWARD—Guide right*, from its chief; as soon as it reaches the line, the section is formed in battery to the front by the commands, *Pieces pass your caissons—MARCH—IN BATTERY—MARCH*, from its chief, (No. 185.)

The other sections continue to advance, and as each arrives opposite its place in battery, after having passed the one preceding it in the formation, it is wheeled to the right, and formed into battery by its chief, in the same manner as the leading section.

The formation in battery on the left, is executed according to the same principles and by inverse means.

When the battery is in column at a halt, it is formed in battery on the right or left, according to the same principles: the chiefs of the two rear sections giving the additional commands prescribed in No. 196.

TO DEPLOY THE DOUBLE COLUMN INTO BATTERY TO THE FRONT OR REAR.

198. The battery being in double column at a halt, to deploy it into battery to the front, the captain commands:

*In column, with caissons in front, to form in battery to the right,
gaining ground to the right.*

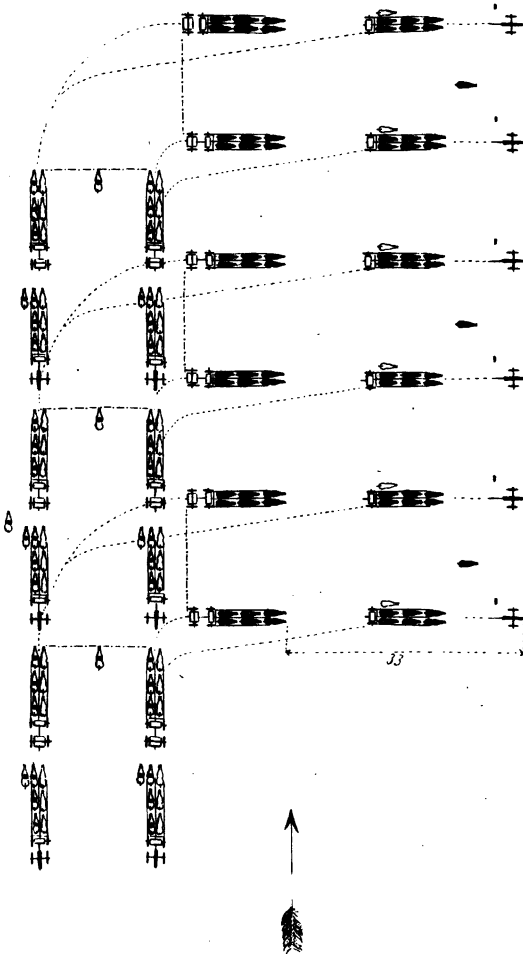

1. *Forward into battery.*
2. MARCH.

At the first command, the chief of the centre section commands : *Section—forward* ; that of the right : *Section into line—right oblique* ; that of the left : *Section into line—left oblique* ; and the chief of the line of caissons goes to the leading section, (No. 190.) At the command MARCH, repeated by the chiefs of sections, the centre section advances five yards, and, without halting, is formed into battery to the front as prescribed in No. 182 or 185, according to the kind of carriage in front.

The pieces of the flank sections are brought upon the line by obliquing, and placed successively in battery without command : regulating by the centre section.

When the battery is marching in double column, it is deployed into battery to the front in the same manner, except that the chief of the centre section does not command, *Section—forward—MARCH.*

When the battery is in double column, marching or at a halt, it is deployed into battery to the rear according to the principles prescribed in this No. and in No. 192 or 193, according to the kind of carriage in front. The commands are :

1. *Into battery faced to the rear.*
2. MARCH.

When the battery consists of four pieces, the double column is deployed into battery to the front or rear, by the same commands from the captain as when it consists of six. The sections are formed into battery as prescribed for the flank sections in this number. The senior chief of section, besides superintending the formation of his own, gives the commands required for the centre section, and the leading pieces conform to the movements of that section.

TO DEPLOY THE DOUBLE COLUMN INTO BATTERY TO THE RIGHT OR LEFT.

199. When the battery is in double column, marching

or at a halt, to form it in battery to the right, the captain commands :

1. *To and on the right into battery.*
2. MARCH.

The centre section is formed in battery on the right, as prescribed for the leading section in No. 196 or 197, according to the kind of carriage in front.

The other pieces are brought into line as prescribed in No. 168, and, without halting, are formed successively in battery to the front without commands; regulating by the centre section.

The deployment into battery to the left, is executed according to the same principles and by inverse means.

When the battery consists of four pieces, the double column is deployed into battery to the right or left, by the same commands from the captain as when it consists of six. In this case the leading pieces are wheeled to the right or left as a section, and conducted to the line by the senior chief of section, as prescribed in No. 168. And then, without halting, they are formed into battery to the front by the same chief. The other pieces move forward, wheel in succession as they arrive opposite their places, and form in battery on the alignment of those already established.

TO PASS FROM THE ORDER IN BATTERY TO THE ORDER IN COLUMN.

200. Being in battery, to form column, the captain first causes the line to be formed as prescribed in No. 188 or 189, and then forms column by one of the manoeuvres for passing from the order in line to the order in column.

TO MARCH BY A FLANK.

201. Being in battery, to gain ground to the left, for the purpose of forming again in battery without an intermediate formation, the captain causes the pieces to be limbered to the rear, and commands :

In battery, to march to the left and form again in battery.



In battery, to march to the left and form again in battery.

Horse Artillery.

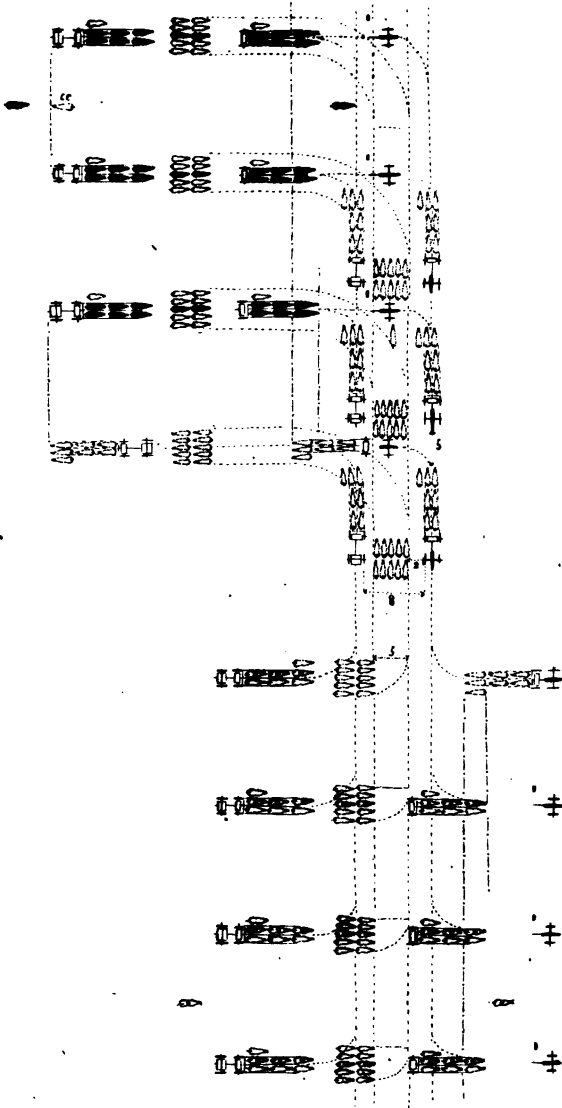

1. *Pieces right—caissons left—wheel.*
2. MARCH.
3. FORWARD.
4. *Guide right.*

(Pl. 55.) These commands are repeated by the chiefs of sections.

At the command MARCH, the carriages wheel as ordered, and, at the third and fourth commands, move forward with an interval of eight and a distance of two yards.

In horse artillery, the interval is also eight yards; but the distance is five. The detachments wheel to the left and march on the left of their pieces as prescribed in No. 145.

The movement to gain ground to the left may be executed by limbering at once to the left; the caissons wheeling to the left while the pieces are limbering; and the captain afterwards commanding, *Forward—MARCH—Guide right.*

In horse artillery, the horse holders move to the left of their pieces when limbering.

The movement to gain ground to the right is executed by either of the methods above described; applying the same principles and inverse means.

As soon as the battery has reached the position on the left, which it is intended to occupy, the captain commands:

1. *Battery—by the left flank.*
2. MARCH.
3. IN BATTERY.

The commands, *By the left flank—MARCH*, are repeated by the chiefs of sections and executed as usual. The command IN BATTERY is given and repeated as soon as the pieces have completed the wheel, and executed as prescribed in No. 187.

(Pl. 56.) *In horse artillery*, the detachments follow the movements of their caissons, and take their places in battery.

When the battery is to move to a flank and be formed into battery again on the same line, it may be executed

by limbering to the front, marching to a flank, and then commanding, *Column—by the right (or left) flank—***MARCH—IN BATTERY**; the caissons taking their proper places in battery by a left about.

The same thing may be executed by limbering to the right or left, gaining ground to the flank, halting, and commanding, **ACTION LEFT** or **ACTION RIGHT**; which will be executed as prescribed in the school of the piece.

In horse artillery, the detachments wheel to the right or left and take their places in battery.

In all cases when a battery is halted or marching in a flank direction, it may be formed into battery to the right or left, by the command **ACTION RIGHT** or **ACTION LEFT**.

In horse artillery, this mode of coming into battery should not be resorted to, when the caissons are required to pass their pieces, except when the detachments are so small that the horses may be easily conducted to their places by the horse holders. In this case the captain commands: **DISMOUNT**, immediately after, **ACTION RIGHT** or **ACTION LEFT**.

FIRINGS.

202. When every thing is prepared for firing, the captain commands:

COMMENCE FIRING.

This command, given by itself or after **LOAD**, is repeated by the chiefs of sections, and the firing immediately commenced.

203. The firing is discontinued by the command or signal, **CEASE FIRING**, which is repeated by the chiefs of sections and pieces.

When the battery is formed for action, the pieces are not loaded until the command, **LOAD** or **COMMENCE FIRING**, is given by the captain. In successive formations, when this command is given, it is repeated in succession by the chiefs of sections, as their sections are formed on the line.

To fire advancing by half battery.

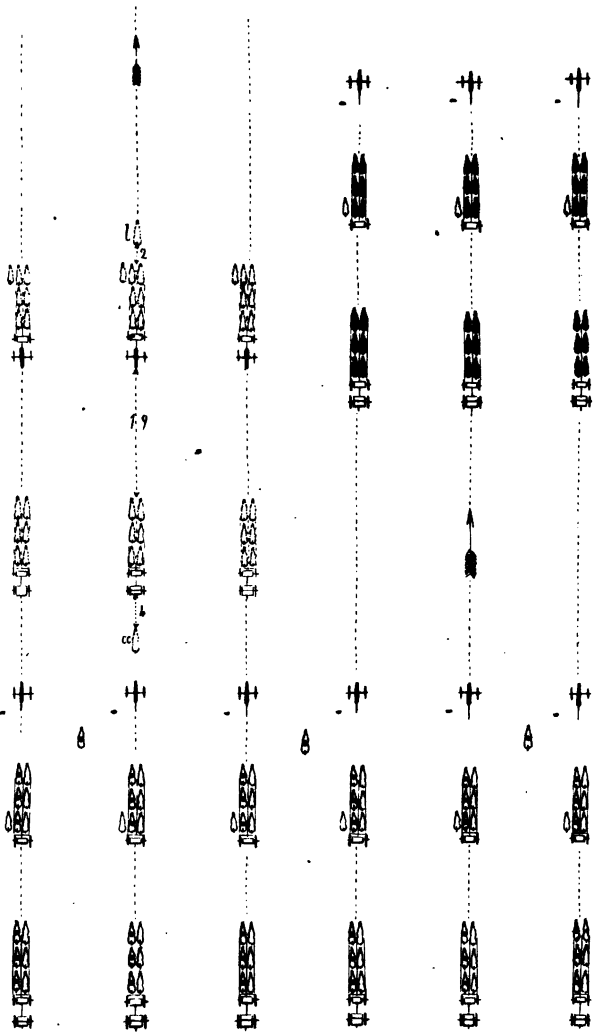

At the command **CEASE FIRING**, such pieces as are loaded must be discharged; except in the case described in the school of the piece when the battery retires with the prolonge, (No. 37.) In no case should a piece be limbered without discharging it, or withdrawing the charge.

TO FIRE ADVANCING.

204. When the battery is firing, to advance by half batteries, the captain commands:

1. *Fire advancing—by half battery.*
2. *Right half battery—ADVANCE.*

(Pl. 57.) At the second command, the chief of the right half battery discontinues firing, causes his pieces to be limbered to the front, and commands; *Forward—MARCH—Guide left.* Or, he may cause them to be limbered to the rear, and, after executing the about, command: *FORWARD—Guide left.* The half battery advances and the caissons preserve their distance in battery.

As soon as the right half battery reaches the new position, previously indicated by the captain, its chief places it in battery by the commands, **HALT—ACTION FRONT**; or **IN BATTERY—MARCH**; the two last commands being given in quick succession. The caissons halt at these commands; and as soon as the pieces are unlimbered, the firing is renewed by command from the chief of half battery.

The fire of the left half battery is continued during the movement of the right; care being taken to direct the pieces, so that their fire shall not injure the half battery in advance.

As soon as the right half battery commences firing, the left moves forward with the guide to the right; and, after passing the right half battery as far as the latter has advanced, is formed into battery, and the firing commenced. The movements of the left half battery, are effected by commands and means corresponding to those of the right.

The right half battery again advances, as soon as the left commences firing; and the two continue to advance alternately until the captain causes the firing to cease. The battery is then aligned, or formed into line to the front or rear by the proper commands from the captain.

While advancing by half battery, the captain places himself habitually with the most advanced portion of the battery, and is accompanied by the chief of the centre section. The chief of the line of caissons remains habitually with the rear half battery.

In horse artillery, while advancing by half battery, the detachments preserve their distance in battery. When the pieces are limbered to the front, the horse holders advance to enable the cannoneers to mount more readily; but as soon as the pieces advance, the detachments resume their distance in battery.

To fire advancing by half battery, commencing with the left, is executed according to the same principles and by inverse means.

The movement may also be executed by section; the sections advancing in succession according to their positions in the battery.

TO FIRE IN RETREAT.

205. When the battery is firing, to retire by half batteries, the captain commands:

1. *Fire retiring—by half battery.*
2. *Right half battery—RETIRE.*

(Pl. 58.) At the second command, the chief of the right half battery discontinues firing, limbers to the rear, and commands: *Caissons left about—MARCH.* As soon as the about is completed he commands: *FORWARD—Guide right*; and conducts the half battery to the ground previously indicated by the captain; the pieces preserving their distance in battery by marching 19 yards in rear of the caissons. As soon as the ground has been reached, the chief of half battery commands: *HALT—IN BATTERY*, and commences firing; taking care not to injure the other half battery. The limbers and caissons

To fire retiring by half battery.

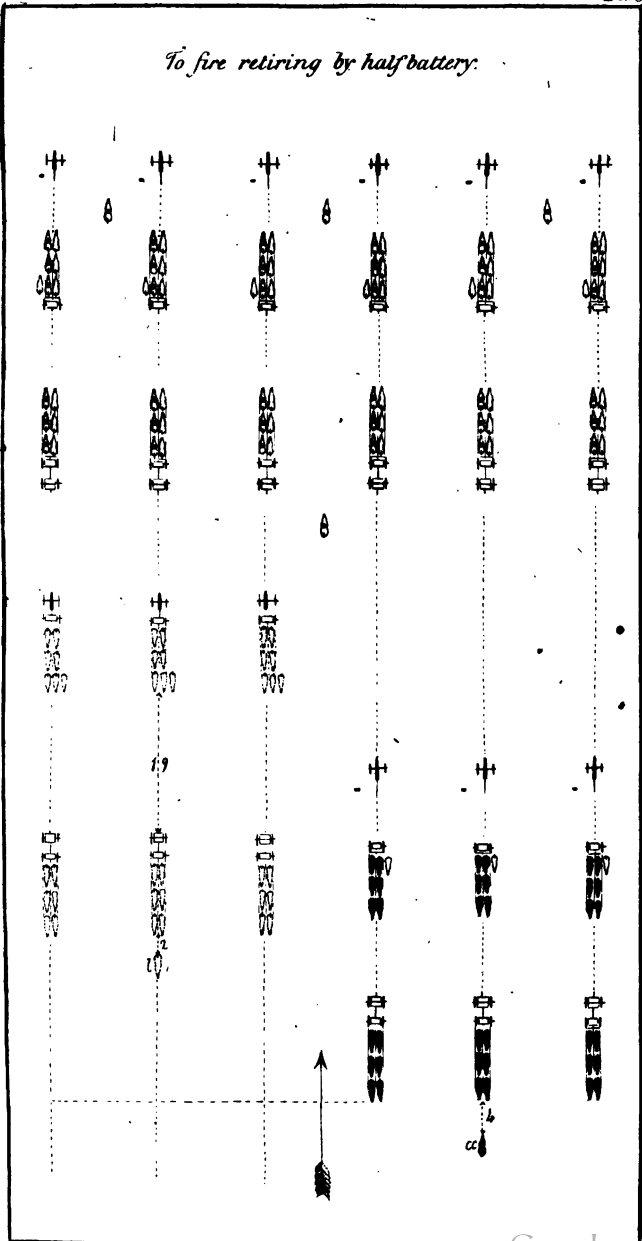

Echelon.

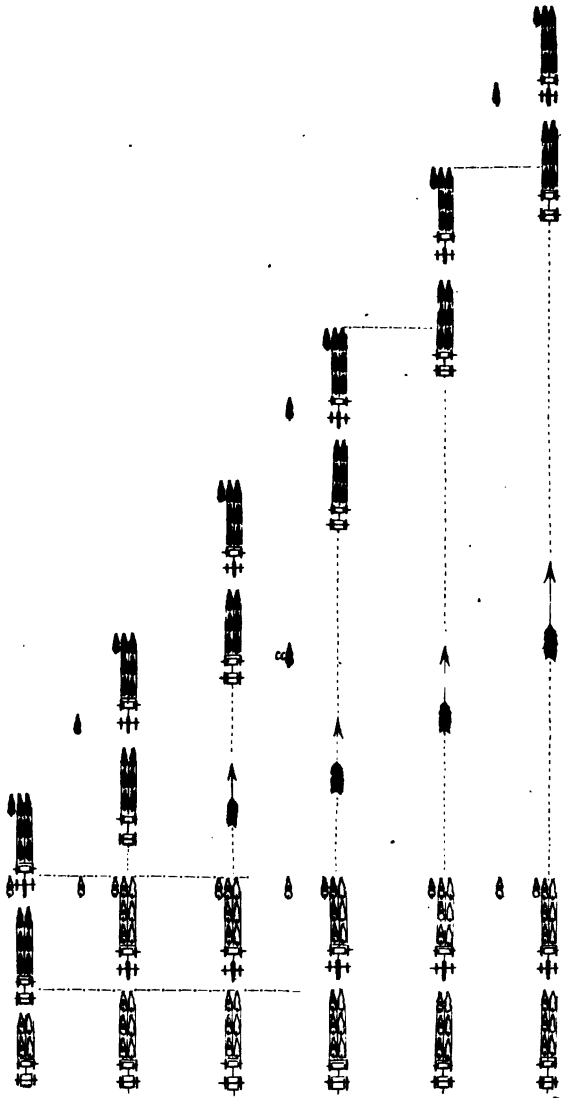

remain facing towards the rear, as long as the firing in retreat continues.

As soon as the right half battery commences firing, the left retires with the guide to the left; and, after passing the right half battery as far as the latter has retired, it is formed into battery, and the firing again commenced. The movements are executed in a manner corresponding to those of the other half battery.

The half batteries continue to retire alternately, until the captain causes the firing to cease. The battery is afterwards aligned, or formed into line to the front or rear, by appropriate commands from the captain.

While retiring by half battery, the captain remains habitually with the portion of the battery nearest the enemy, and is accompanied by the chief of the centre section. The chief of the line of caissons accompanies the other half battery.

In horse artillery, the detachments move to the left to facilitate the about of the caissons. They afterwards place themselves behind and follow them during the retrograde movement at the distance of two yards; remaining faced to the rear as long as the firing in retreat continues.

To fire retiring by half battery, commencing with the left, is executed according to the same principles and by inverse means.

The movement may also be executed by sections; the sections retiring in succession according to their positions in the battery.

MOVEMENTS FOR FIRING IN ECHELLON.

206. When the battery is in line at a halt with pieces in front, to advance in echellon of pieces, the captain commands:

1. *By piece from the right—front into echellon.*
2. MARCH.

(Pl. 59.) At the last command, the right piece moves forward, followed by its caisson. The next piece moves forward in like manner as soon as its leaders are abreast

the wheel horses of the rear carriage on the right; and the other pieces commence the movement in succession according to the same rule.

The officers preserve the same relative positions as in line.

When the battery is marching in line at a walk or trot, the echelon is formed according to the same principles and by the same commands; the gaits being regulated as in breaking sections.

The battery advances in echelon of pieces from the left according to the same principles and by inverse means.

When the caissons are in front, the battery advances in echelon of pieces from the right or left according to the same principles and by the same commands.

When the battery is in echelon, marching or at a halt, it may be formed into battery to the front, rear, right or left, as explained in Nos. 183, 184, 185, 186, and 187.

When firing in echelon to the front or rear, the direction of the fire may be changed to the right or left. For this purpose the captain orders the firing to cease, and commands: ACTION RIGHT (OR LEFT.) At this command, the trails of the pieces are turned to the left (or right), and the limbers and caissons take their places in rear of the pieces. But if retiring with the prolonge fixed, the caissons stand fast, and the limbers back to allow the trails to be turned in the proper direction. The prolonge must be sufficiently slack to allow the recoil of the guns. This last method is only applicable to firing to the right when retiring by the right, and to the left when retiring by the left.

TO FIRE TO THE REAR.

207. When the battery is firing, to fire to the rear, the captain causes the firing to cease and commands:

1. *Fire to the rear.*
2. *Limbers and caissons pass your pieces—trot.*
3. MARCH.

To fire to the rear.

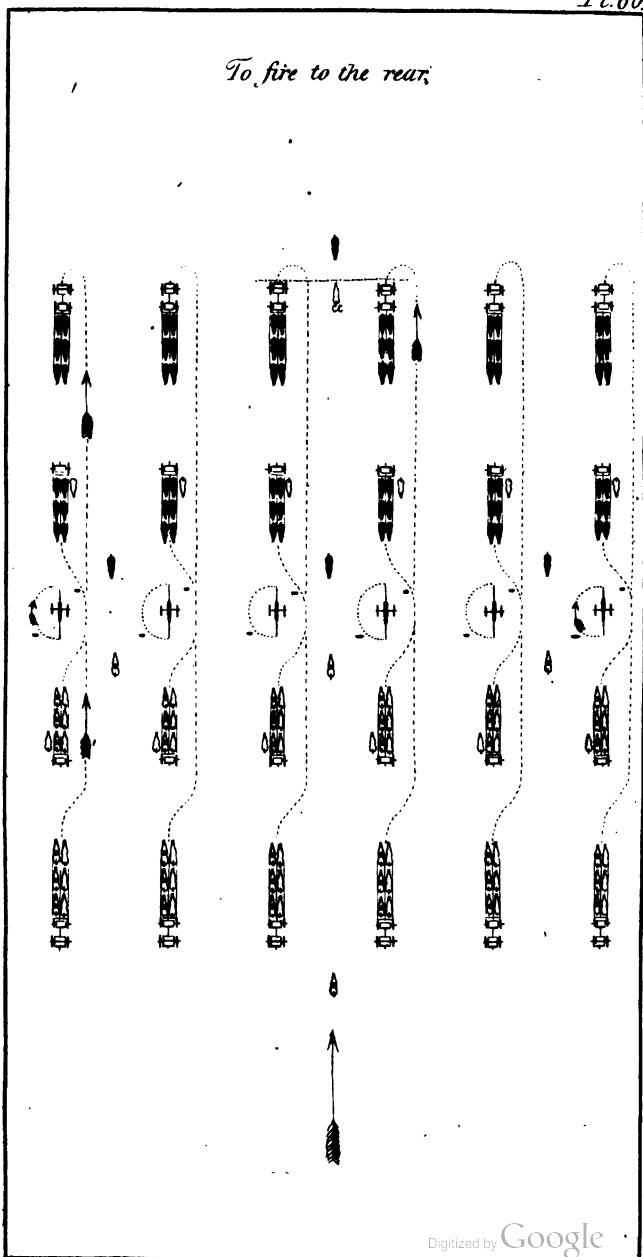

(Pl. 60.) These commands are repeated by the chiefs of sections. At the command MARCH, the pieces are wheeled about by turning the trails to the left; and the limbers and caissons oblique to the right, pass them, and take their places in battery by a left reverse.

In horse artillery, the horses follow their limbers, pass them, and take their places by wheeling about to the left. When the horse holders cannot conduct them alone they are assisted by Nos. 1 and 2.

When the pieces cannot be wheeled about by hand, the captain commands :

1. *Fire to the rear.*
2. LIMBER TO THE REAR.
3. *Caissons pass your pieces—trot.*
4. MARCH.
5. *Pieces left about.*
6. MARCH.
7. IN BATTERY.

CHANGES OF FRONT IN BATTERY.

CHANGE OF FRONT TO FIRE TO THE RIGHT, LEFT WING FORWARD, AND THE REVERSE.

208. When the battery is firing, if the captain wishes to make a perpendicular change of front, to fire to the right, throwing forward the left wing, he discontinues firing and commands :

1. *Fire to the right.*
2. *Change front forward on the right piece.*
3. MARCH.

(Pl. 61.) At the second command, the chief of the right section places the right piece in the new direction, by causing the trail to be moved to the left. He also causes the left piece of his section to be moved forward by hand, and established on the new line. When the ground is unmasked, the limbers and caissons of these pieces oblique to the left, move forward, and take their

places in battery by wheeling to the right; the caissons aligning themselves by the chief of the line of caissons established on the right.

The other chiefs of sections cause their pieces to be limbered by the command, **LIMBER TO THE FRONT**; the caissons, and in *horse artillery* the horse holders also, closing upon the pieces while they are limbering. As soon as they are limbered; the chiefs of sections command: *Forward*.

At the second command, the chief of the line of caissons places himself on the left of the right piece of the centre section, facing to the front, to mark the right of the new line of caissons.

At the command **MARCH**, repeated by the chiefs of the centre and left sections, these sections move to the front; and, when each has arrived opposite its place on the new line, its chief commands: *Section—right wheel—MARCH—FORWARD*; and afterwards, *In battery—MARCH*, so as to form upon the alignment of the right section. When the caisson of the right piece of the centre section reaches the point where its piece wheeled, it wheels to the left, takes its distance in rear, wheels about and dresses to the right upon the line of caissons. The other caisson of the same section, obliques to the left when its piece commences the wheel; and, after gaining its distance, establishes itself on the line by wheeling and dressing to the right.

When the pieces are too heavy to be moved or wheeled about by hand, the chiefs of sections cause them to be limbered, with the exception of the right piece, by the command **LIMBER TO THE REAR**. The chief of the right section then commands: *Piece left about—caisson forward*; and the chiefs of the other sections: *Pieces left about—caissons forward*. At the command **MARCH**, repeated by the chiefs of sections, the pieces are wheeled about and directed to the front by the command **FORWARD** from the chiefs of sections. The left piece of the right section is established on the line by the commands, *Right wheel—MARCH—FORWARD—In battery—MARCH*, from the chief of the section. The caisson wheels to

Change of front to fire to the right, left wing forward.

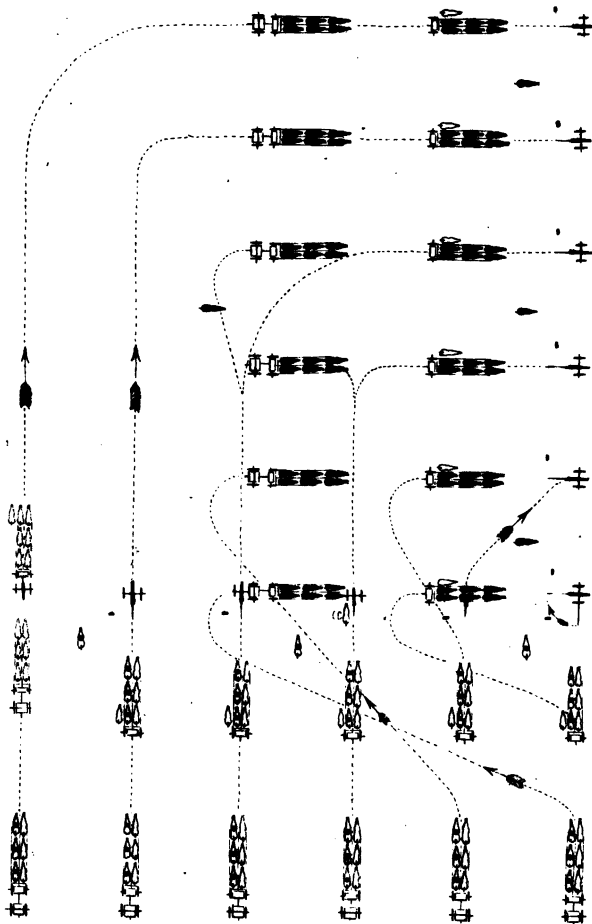

the left when it reaches the point where its piece wheeled to the right; and, after taking its distance, wheels about and dresses to the right upon the chief of the line of caissons. The other sections are established upon the line as already described.

The pivot piece commences firing again, as soon as it is in position, and the others as they arrive on the line.

The change of front to fire to the left, right wing forward, is executed according to the same principles and by inverse means.

In horse artillery, the detachments follow their pieces and halt at the proper distance from the line. That of the left piece of the right section, when limbered, wheels to the left when its piece wheels to the right, allows its caisson to pass it, and takes its place by wheeling about to the left. The horse holders of the pieces not limbered, oblique to the left with their limbers, and, like them, take their places in battery by wheeling to the right. When it is deemed advisable, the captain may retain the cannoneers at their pieces, and allow all the horse holders to conduct their horses to the new line. The same may be done in the other changes of front.

CHANGE OF FRONT TO FIRE TO THE LEFT, LEFT WING FORWARD, AND THE REVERSE.

209. When the battery is firing, if the captain wishes to make a perpendicular change of front to fire to the left, throwing forward the left wing, he discontinues firing and commands :

1. *Fire to the left.*
2. *Change front forward on the right piece.*
3. MARCH.

(Pl. 62.) At the second command, the chief of the right section causes the right piece to be placed in the new direction at once, by moving the trail to the right; and the limber and caisson of that piece will oblique to the right, and take their places in its rear by wheeling to the left; the caisson dressing upon the chief of the line of caissons. He also causes his left piece to be

moved to its place and established on the line by hand ; the limber of this piece, passing it on the right, takes its place by wheeling to the left, its caisson obliqués to the right, passes on the right, and in rear, of the right caisson, and takes its place also by wheeling to the left.

The chiefs of the other sections cause them to be limbered to the front ; and while limbering they command : *caissons pass your pieces—trot—MARCH*. When this is executed the chief of the centre section commands : *Section—right wheel*, and that of the left : *Forward*.

At the command *MARCH*, repeated by the chiefs of the centre and left sections, these sections move as ordered, with the caissons leading. The centre section is conducted to the line by its chief and formed by the commands, *FORWARD* and *IN BATTERY*. The left section advances five yards and is conducted to the line by two successive right half wheels. It is there formed in like manner upon the alignment of the right section.

At the second command from the captain, the chief of the line of caissons places himself in prolongation of the line, 32 yards on the right of the right piece, and faces to the front, to mark the left of the new line of caissons.

When the pieces are too heavy to be wheeled about or moved by hand, the chiefs of sections cause them to be limbered to the rear, with the exception of the right piece. While the pieces are limbering, the chiefs of the centre and left sections cause the caissons to pass as before ; and all the chiefs of sections give the cautionary command for their pieces to wheel about. At the command *MARCH*, repeated by the chiefs of sections, the pieces are wheeled about, and the sections conducted to the new line by the appropriate commands. The caisson of the left piece of the right section, takes its place, in the same manner, as when its piece is moved by hand.

The pivot piece re-commences firing as soon as it is unmasked ; and the others when they arrive on the line.

The change of front to fire to the right, right wing forward, is executed according to the same principles and by inverse means.

Change of front to fire to the left, left wing forward.

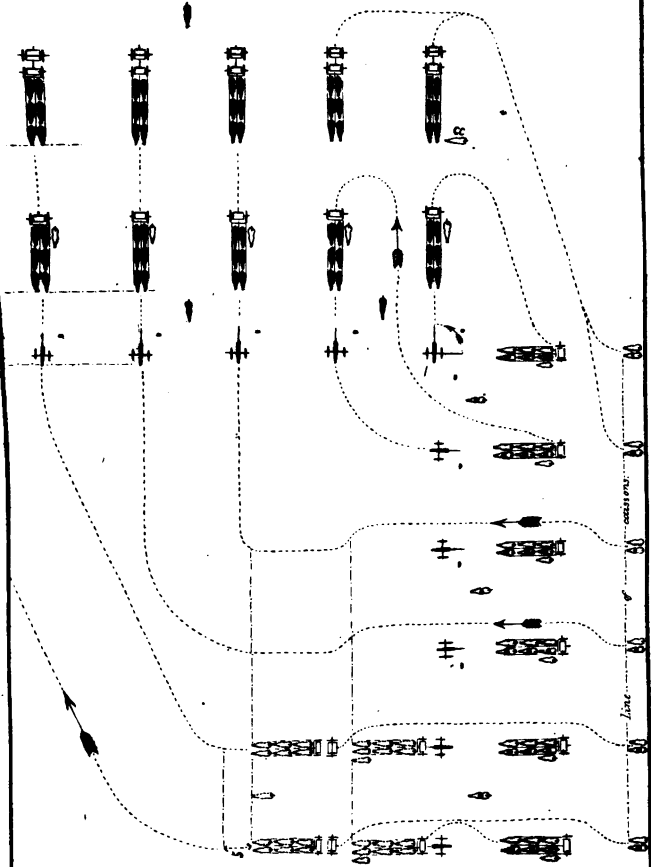

Change of front, to fire to the left. left wing to the rear.

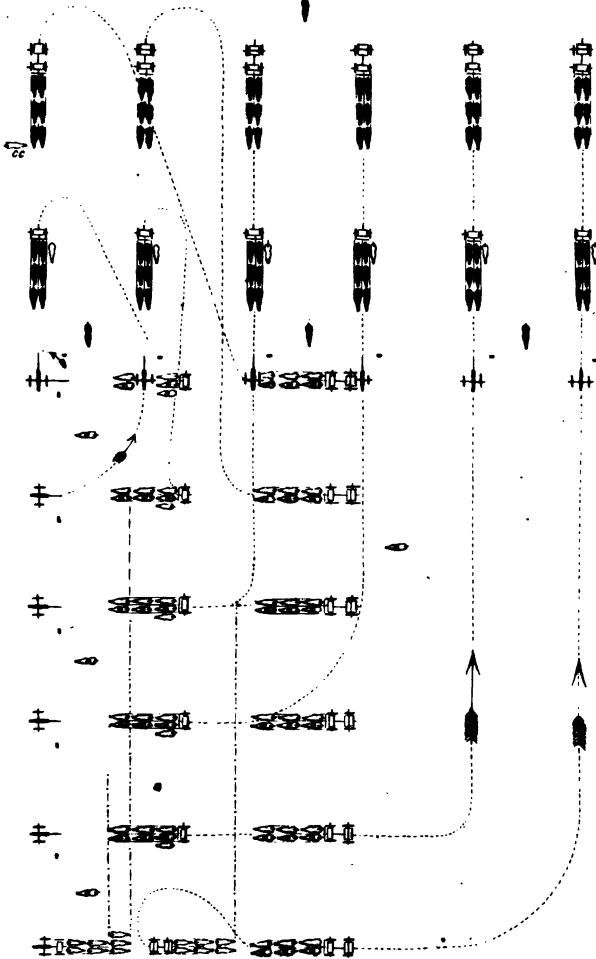

In horse artillery, the horse holders of those pieces, which are placed on the line by hand, conduct the horses to their positions in battery by following their limbers.

CHANGE OF FRONT TO FIRE TO THE LEFT, LEFT WING TO THE REAR, AND THE REVERSE.

210. When the battery is firing, if the captain wishes to make a perpendicular change of front to fire to the left, throwing the left wing to the rear, he causes the firing to cease and commands :

1. *Fire to the left.*
2. *Change front to the rear on the right piece.*
3. MARCH.

(Pl. 63.) At the second command, the chief of the right section places the right piece in the new direction, by causing the trail to be moved to the right. He also causes the left piece of his section to be moved to the rear by hand and established on the new line. The limbers and caissons of these pieces move at once to the right, obliquing sufficiently to place themselves in rear of their respective pieces, and take their places by wheeling to the left or left about.

The other chiefs of sections command : *Limber to the rear*, and immediately afterwards, *Caissons in front of your pieces—trot—MARCH* ; The caissons place themselves in front of their pieces, while they are limbering, and halt as prescribed in No. 189. The chiefs of these sections then command : *Forward*.

The chief of the line of caissons places himself in the prolongation of the line, thirty-two yards on the right of the right piece, and faces to the rear to mark the right of the new line of caissons.

At the command MARCH, given by the captain, and repeated by the chiefs of the centre and left sections, the chiefs of these sections command : *Guide left*, and afterwards in succession, *Section—left wheel—MARCH—FORWARD—IN BATTERY*. The carriages dress towards the pivot as they arrive on the line.

When the pieces are too heavy to be moved by hand, the chief of the right section causes his left piece to be limbered to the rear with the rest, and then commands : *Left wheel.* At the command MARCH, repeated by this chief, the piece wheels to the left and is conducted by him to its place by the commands, FORWARD—IN BATTERY. The caisson takes its place as before described.

The pivot piece recommences firing as soon as it is unmasked ; and the others when they arrive on the line.

The change of front to fire to the right, right wing to the rear, is executed according to the same principles and by inverse means.

In horse artillery, the detachments pass their pieces at the command MARCH, place themselves two yards in rear of the muzzles, follow them, and, at the command IN BATTERY, take their places by the regular movement described in No. 187. The horse holders of those pieces, which are moved by hand, follow their limbers and conduct the horses to their positions, by movements corresponding to those of their caissons. When the left piece of the right section is limbered, the horses of the detachment are conducted to their places in the same manner, as though the piece were unlimbered, except that the detachment mounts.

CHANGE OF FRONT TO FIRE TO THE RIGHT, LEFT WING TO THE REAR, AND THE REVERSE.

211. When the battery is firing, if the captain wishes to make a perpendicular change of front to fire to the right, throwing the left wing to the rear, he discontinues firing and commands :

1. *Fire to the right.*
2. *Change front to the rear on the right piece.*
3. MARCH.

(Pl. 64.) At the second command, the chief of the right section commands : *Limbers and caissons in rear of your pieces—trot—MARCH.* The limbers and caissons oblique to the right and pass their pieces with the limbers leading. As soon as the limbers have passed, they

Change of front, to fire to the right, left wing to the rear.

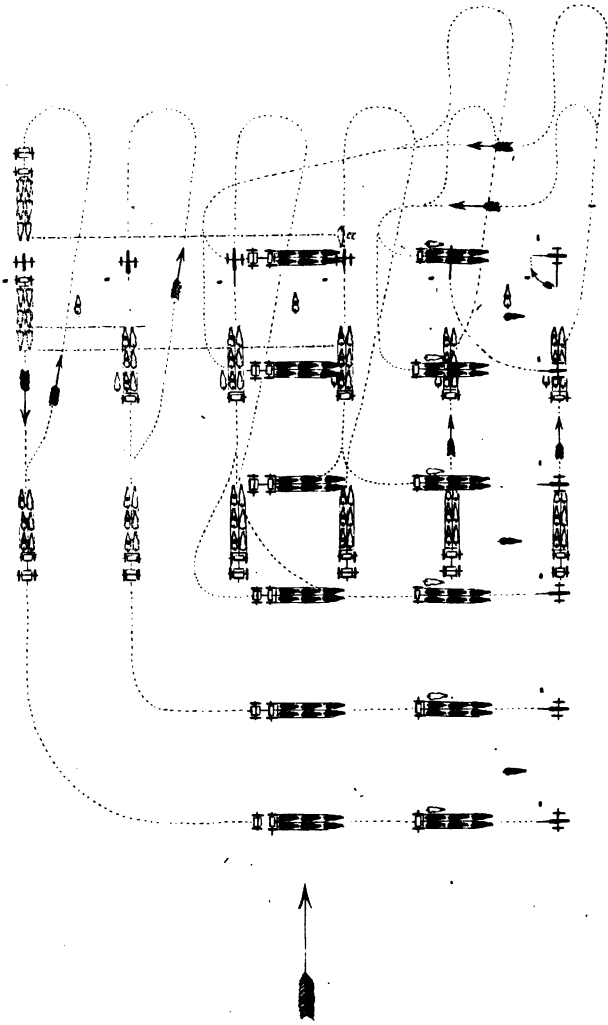

wheel twice to the left and cover their pieces. The caissons pass the limbers and cover them in like manner. The chief of the section causes the trail of his right piece to be moved to the left, and his left piece to be placed upon the new alignment by hand.

The chiefs of the other sections command: **LIMBER TO THE REAR**, and *Caissons in rear of your pieces—trot*—**MARCH**. When this is executed they command: *Forward*.

At the second command, the chief of the line of caissons places himself on the left of the right piece of the centre section, facing to the rear, to mark the left of the new line of caissons.

At the command **MARCH** from the captain, repeated by the chiefs of the centre and left sections, those sections, as well as the limbers and caissons of the first, are established upon the new line as described in No. 208.

When the pieces cannot be moved by hand, the chief of the right section causes his left piece to be limbered like the rest; and then causes the remaining limber, and the caissons, to pass as before described. When the piece is limbered, he commands: *Left wheel*. At the command **MARCH**, from the captain, repeated by the chiefs of sections, the piece is wheeled and conducted to its place on the line as in No. 208.

The pivot piece recommences firing as soon as it is placed in the new direction; and the others as they arrive on the line.

The change of front to fire to the left, right wing to the rear, is executed according to the same principles and by inverse means.

In horse artillery, the mounted detachments pass their pieces with the caissons at the command **MARCH**, and take their places in rear of the muzzles by successive wheels to the left. The horse holders of the pieces which are moved by hand follow their limbers and wheel into their places in like manner. The remainder is executed as in No. 208.

TO PASS A DEFILE IN FRONT.

212. When the battery is firing, to pass a defile in front of the right section, the captain commands :

1. *To the front—by the right section—pass the defile.*
2. MARCH.

(Pl. 65.) At the first command, the chief of the right section discontinues firing, limbers his pieces to the front, and commands: *Forward*. At the command MARCH, repeated by this chief, who also commands: *Guide left*, the section moves forward, passes the defile, and is again established in battery and the firing commenced by his command.

When the pieces are too heavy to be wheeled about by hand, the chief of the section causes them to be limbered to the rear, wheeled about, and the caissons closed, before giving the command *Forward*.

As soon as the right section commences firing, the centre is put in motion in like manner. Its chief conducts it through the defile by successive wheels, and forms it into battery in line with the first.

As soon as the centre section commences firing the left passes in like manner.

While one section is passing the defile, the others continue firing; care being taken not to injure the section in advance.

When the defile is in front of the left section, it is passed according to the same principles, commencing with that section.

When the defile is in front of the centre section, it is passed according to the same principles, commencing with that section, and by the commands, *To the front—by the centre section—pass the defile—MARCH*. Unless there is some reason to the contrary, the right section will pass before the left.

When the flank or oblique march is better suited to the nature of the ground, the chiefs of sections will give the required commands.

When the defile will admit but one piece at a time, the sections are broken by their chiefs in such a manner,

In battery, to pass a defile in front of the right wing.

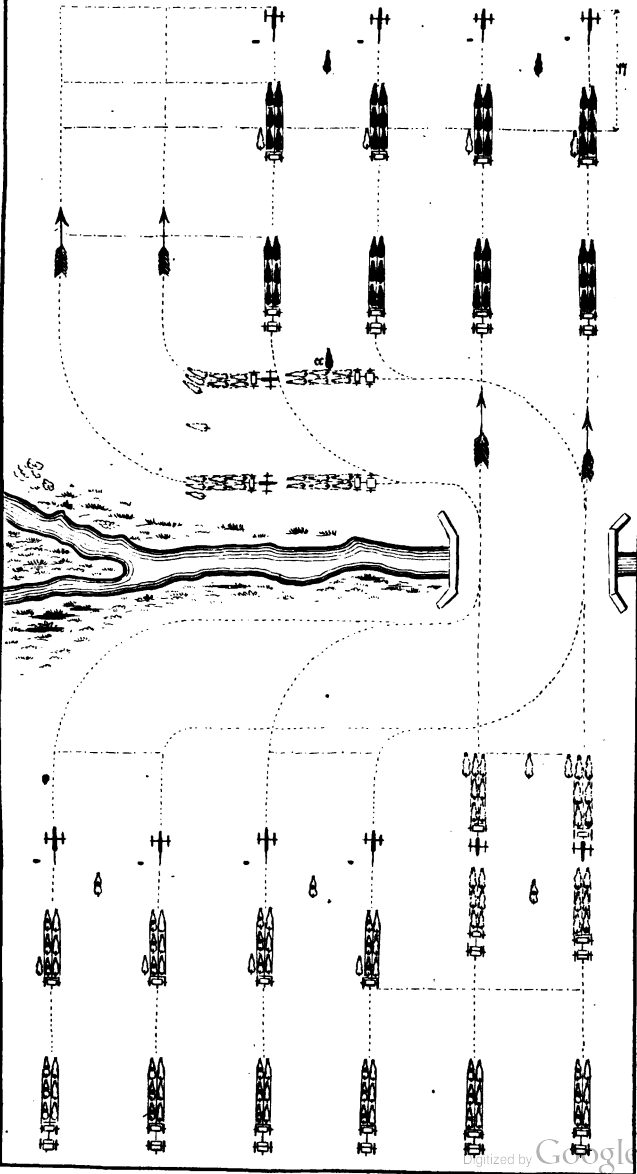

In batteries; to pass a defile in rear of the centre.

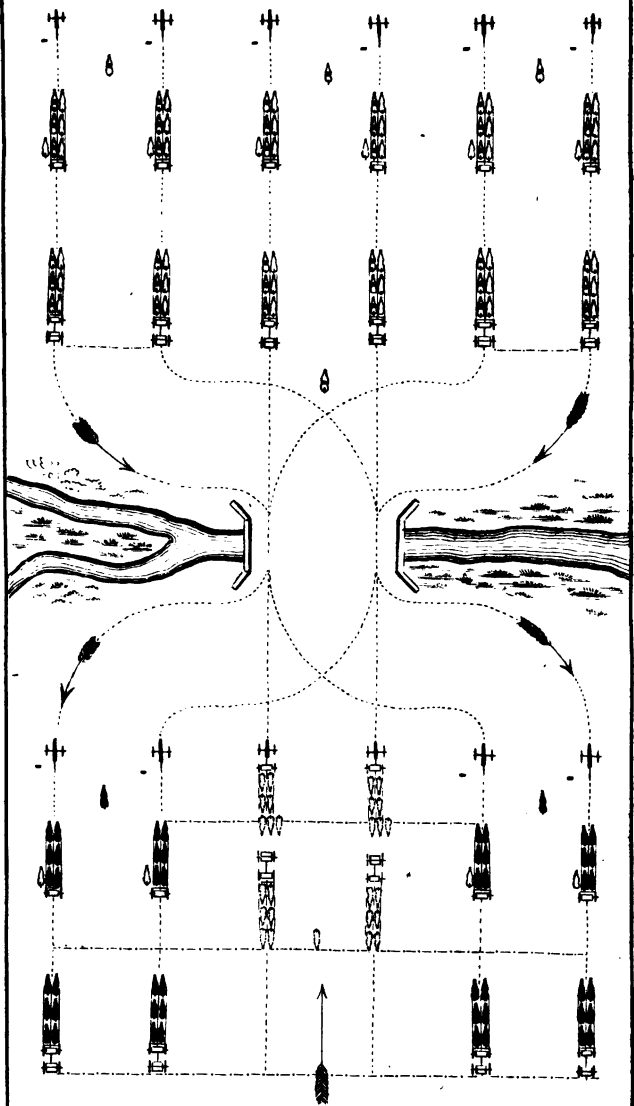

as to cause the nearest piece to enter first. The sections are re-formed by their chiefs immediately after passing the defile.

TO PASS A DEFILE IN REAR.

213. When the battery is firing, to pass a defile in rear of the centre section, the captain commands :

1. *To the rear—by the right section—pass the defile.*
2. MARCH.

(Pl. 66.) At the first command, the chief of the right section discontinues firing, limbers to the rear, and commands: *Caissons left about—pieces forward.* At the command MARCH, repeated by the chief of the right section, the caissons of that section execute the about, and the pieces close to their proper distance at a trot. As soon as the about is completed, the chief commands: FORWARD—*Guide left*, conducts the section through the defile by successive wheels, and forms it into battery in rear of its first position.

The left section is put in motion as soon as the right commences firing. It is conducted through the defile by its chief, and formed into battery in rear of its first position, by the principles already described.

The centre section moves as soon as the left commences firing. It is formed into battery in rear of its first position, and in line with the other two sections.

The passage of the defile may be executed, commencing with the left section, according to the same principles and by inverse means.

When the defile is in rear of one of the flanks, the movement should commence with the other. It should always end by passing the section or piece covering the defile.

When the defile will admit but one piece at a time, the sections are broken by their chiefs in such a manner, as to cause the piece farthest from the defile to enter first; and the sections are again formed, as soon as possible after leaving the defile.

PARADE FOR REVIEW AND INSPECTION.

214. The battery being in line with the trumpeters on the right, the captain commands :

1. *Attention.*
2. *Prepare for review.*
3. *To the rear open order.*
4. MARCH.
5. *Right—DRESS.*
6. FRONT.

(Pl. 67.) At the third command, the chief of the line of caissons commands: *Caissons—left reverse*, and places himself on the right flank, sixteen yards in rear of the line of pieces, facing to the left, to mark the point where the right of the line of caissons is to rest. In horse artillery the distance is twenty yards.

At the same command, the gunners face the detachments to the rear in foot artillery, by the command *About—FACE*; and in horse artillery they command *Backward*.

At the command MARCH, repeated by the chief of the line of caissons, the caissons reverse to the left, move to the rear, reverse again to the left, and align themselves by appropriate commands from the chief of the line of caissons. As soon as the ground is unmasked, the gunners repeat the command MARCH, at which the cannoners in foot artillery march forward, and are formed six yards in rear of their pieces, as described in No. 14; the chiefs of caissons joining their detachments at the same time. In horse artillery the cannoners rein back and are halted by the gunners at the same distance.

At the fifth command the battery is aligned; the pieces and detachments by the captain, and the caissons by the chief of the line of caissons. At the sixth command, given by the captain when the alignment is completed, the chief of the line of caissons takes his post as in line. The captain then commands :

Draw—SWORDS,

Parade for review and inspection.

Horse Artillery.

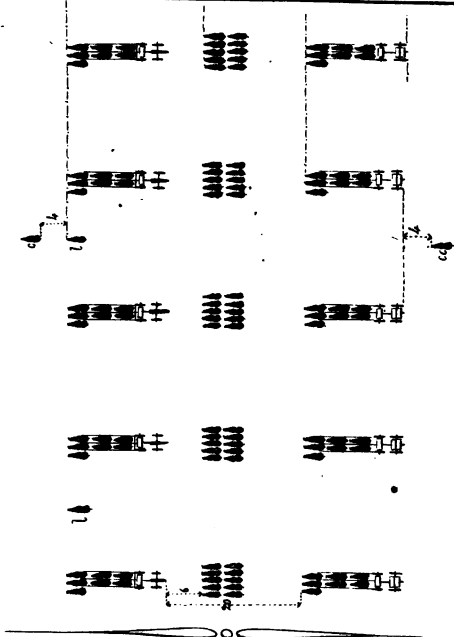

Foot Artillery.

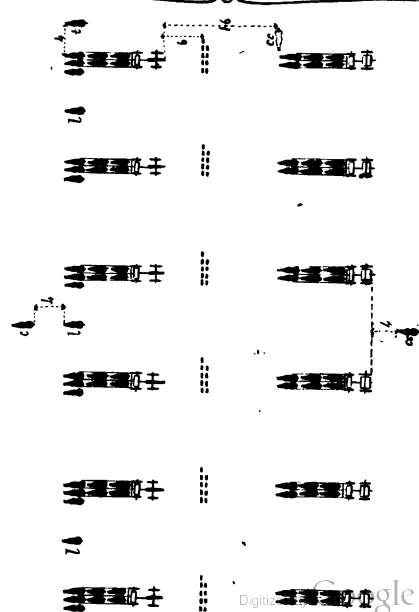

This is executed by the officers, non-commissioned officers, and detachments only, and the captain takes his post as in line.

In this order the battery awaits the approach of the reviewing officer. When he is midway between the camp color and the captain, the latter turns his horse to the right about and commands :

Present—SWORDS.

He immediately resumes his front and salutes. The officers, non-commissioned officers, and detachments all salute as in cavalry ; and the music plays according to the rank of the reviewing officer.

The reviewing officer having halted and acknowledged the salute, the captain brings his sword to a carry, turns about to the line as before, and commands :

Carry—SWORDS.

He immediately resumes his front, the reviewing officer turns off to the right of the battery, passes along its front, and returns to the right by passing between the lines of carriages or in rear of the caissons. While the reviewing officer is passing around the battery, the music plays. It ceases when he turns off to take his post at the camp color.

When the music ceases, the captain turns about and commands :

1. *Detachments.*
2. *Return*—SWORDS.
3. *Battery.*
4. *Close order.*
5. MARCH.

In horse artillery the first and second commands are not given.

At the fourth command, the gunners in foot artillery command : *Left*—FACE, and in horse artillery, *Forward*.

At the command MARCH, repeated by the gunners, the cannoneers in foot artillery take their posts as prescribed in No. 2. The caissons, and in horseartil-

lery the cannoneers, close to their proper distances in line.

The reviewing officer having taken a position near the camp color, the captain causes the cannoneers to mount, if in foot artillery, and breaks the battery into column of sections to the right by the usual commands. He then commands :

Pass in review.

And puts the column in march, at a walk, with the guide to the right. The captain then places himself at the head of the column, four yards in advance of the chief of the leading section. The trumpeters march four yards in advance of the captain ; and the chief of the line of caissons outside the column, opposite the centre, and four yards from the left flank.

When the head of the column has arrived within forty yards of the reviewing officer, the music begins to play ; and as soon as the latter has passed, it wheels out of the column to a position in front of the reviewing officer, where it faces him, and continues to play until the column has passed. It then ceases, follows in rear of the battery, and resumes its place at the head of the column after the next change of direction.

All the officers salute in succession as they arrive within six yards of the reviewing officer ; casting their eyes towards him at the same time, and bringing their swords to a carry after having passed him six yards. As soon as the captain has saluted, he places himself near the reviewing officer, remains until the rear has passed, and then rejoins his battery.

The column is so conducted as to march parallel to the line on which the battery is to form, and far enough in its rear to enable the column to wheel into line. It is then wheeled into line, the ranks opened, and the review terminated by a salute as at the beginning.

When instructions have been previously given to pass a second time, either at a trot or gallop, it will be done before wheeling into line ; the officers passing the second time without salute.

When artillery has been passing in review with other troops, and is marching in prolongation of the line on which the different corps are to form, it may be wheeled by sections to the right, and after gaining the necessary distance, countermarched and established on the line.

When a battery is to march past in line, or in column of half batteries, it will be done according to the principles already described. In line the officers will be at their usual posts. In column of half batteries the captain will be two yards in advance of the chief of the leading half battery; each chief of half battery two yards in front of the centre of his command; the chief of the centre section on the left of the leading half battery, four yards from the leading driver; and the chief of the line of caissons in the same position with respect to the rear half battery.

In all cases the trumpeters are four yards in front of the captain.

When the battery is to be minutely inspected, the captain will cause the ranks of the detachments to be opened, if required, by the commands:

1. *Detachments.*
2. *To the rear open order.*
3. MARCH.

Which will be executed as in infantry or cavalry, as the case may require.

ORDER OF ENCAMPMENT FOR A BATTERY OF ARTILLERY.

Plates 1 and 2 represent the ordinary modes of encampment. Other modes, or combinations of these two, are adopted when the circumstances require.

1ST MODE.

In this mode the pieces are parked with diminished intervals; and the tents and horses are placed upon the flanks in lines parallel to each other and perpendicular to the front, so as to give the encampment a front of the same extent as the battery in line. The horses of each half battery are picketed together upon their appropriate flank. The team of the flank piece is placed at the end of the picket rope in front, and that of its caisson next. Then come the teams of the next piece and caisson, and so on in the same order. The horses of the chiefs of pieces are with their appropriate teams. The teams of the other carriages are afterwards picketed in the same order with reference to their positions in park; and finally the horses of the officers near the end of the rope.

When two or more batteries are encamped together, the interval between the camps is equal to that between two batteries in line; and the captain's tent is between those of his lieutenants.

In horse artillery, the front of the encampment would be 97 yards, and the interval between the pieces 7. The horses of each detachment would be picketed after the teams of its caisson.

2ND MODE.

In this mode the pieces are parked with full intervals, and the horses and tents are placed in parallel lines in rear. When a single line of picket rope is not sufficient for the horses, a second is placed four yards in rear of

1st PLAN OF ENCAMPMENT, for Foot Artillery.

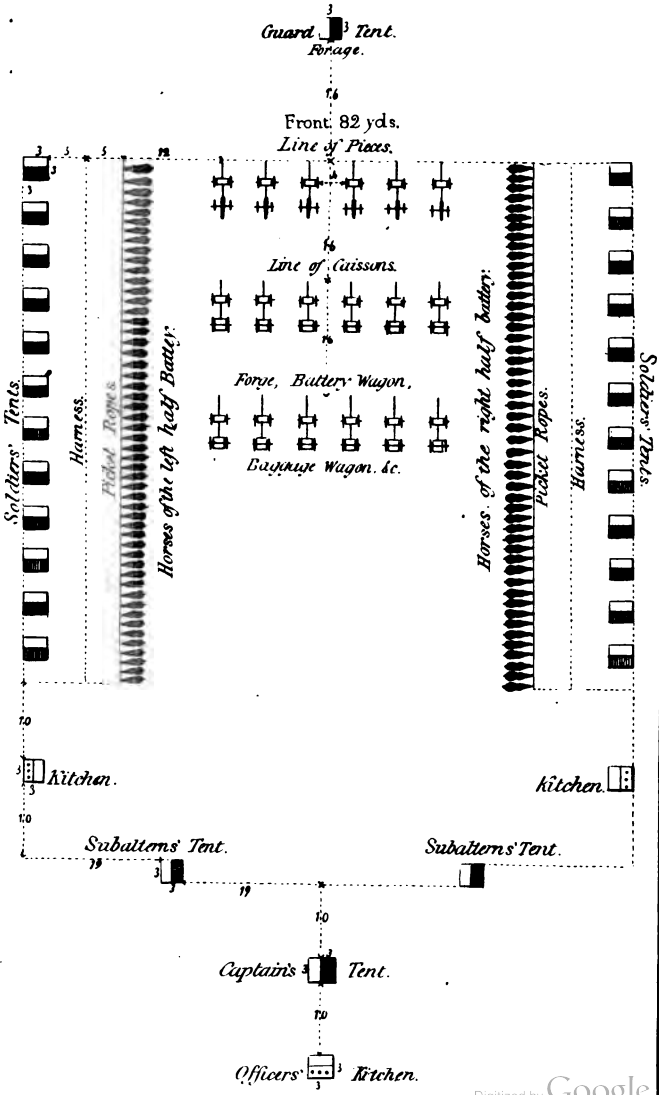

2^d PLAN OF ENCAMPMENT.

for Foot

Guard Tent.
Forge

Artillery.

Front 82 yds.

Line of Pieces.

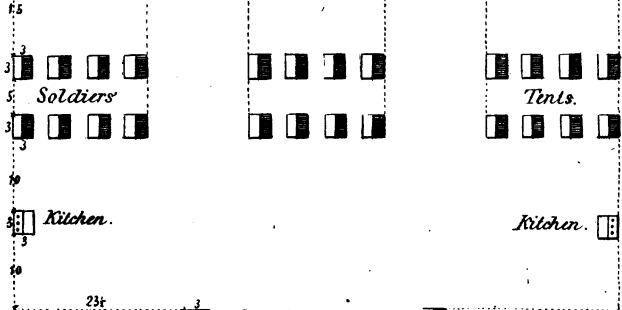
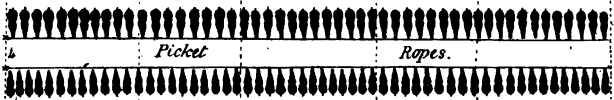
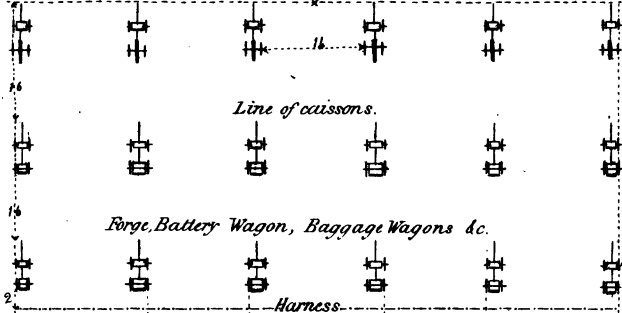

Subalterns' Tents.

Captain's Tent.

Officers' Kitchen.

the first, and the horses made to face each other. The teams of the pieces and caissons are placed in the order of their pieces along the centre of the first line, and those of the other carriages are placed upon their flanks opposite the half batteries to which they belong. If necessary a part of them are placed in rear of the second line. The horses of the officers are at the extremities of the line.

In horse artillery, in which the second line is always necessary, the horses of the detachments are picketed together in their proper order along the centre of that line; and the officers' horses at the extremities of the same.

In this mode of encampment the interval between two adjoining batteries and the position of the captain's tent are subject to the same rules as in the other.

Instead of placing the harness in lines as represented in the plates of the preceding modes of encampment, it may be placed upon the carriages and covered by tarpaulings when it is possible to do so. The saddles and bridles of the riding horses may also be covered by placing them in the tents with the men.

The number of lines upon which a battery is parked varies according to the number of spare carriages attached. The battery of manœuvre, which is composed of the pieces and their appropriate caissons, occupying the two front lines.

SUPPLEMENT.

REMARKS.

The battery should frequently take out a day's forage, secured and arranged as for service; the detachments being in marching order, and their blankets, &c. properly fixed.

It should be made to go over all sorts of ground, up and down steep slopes and across ditches. The intrenching tools should be occasionally taken off, and used in filling up holes and making ramps, to enable the carriages to pass over difficult ground.

MARCHES.

The front of a column should not be frequently diminished and increased on a long march, as it unavoidably increases the fatigue of the column, particularly the rear of it: when, therefore, the front is diminished, it should not be increased until there is a probability that it will not be necessary to diminish it again for sometime.

The detachments should be told off into two parties, one for the piece, the other for the caisson, in order to give their assistance in holding on, or whenever it may be required on the march, &c.

The officers commanding sections, in order to preserve them in place, will, without waiting for express instructions, give such orders as may be necessary for holding on in descents, for assisting horses out of difficulties, for the passage of obstacles, &c.

Artificers should always be carried on a march, as their duties commence when that of the other men may be said to end, and, if fatigued with marching, they cannot be expected to work with alacrity or efficiency, however willing.

An intelligent non-commissioned officer should be sent to reconnoitre the road or ground that artillery is to pass over, and, when necessary, to report the state of it. When the march is connected with military operations, an officer should be employed for this duty.

The distance of two yards between the carriages should always be maintained on the best roads, to prevent fatigue and unnecessary stoppage to the horses. In bad or difficult roads, it may be necessary to increase the distance to four yards or more, according to the nature of the ground. Even infantry, under such circumstances, open out and lose distance; with artillery it is unavoidable, and the horses suffer much from being alternately checked and urged on.

The strictest attention, however, should be constantly paid to the preservation of distances; not opening out more than is absolutely necessary. The loss of distances with small bodies of artillery may be made up; but with large bodies, or when acting with infantry, this cannot be done without serious disadvantage, particularly to the infantry; therefore, this point cannot be too strongly insisted upon, as being one of essential consequence.

Officers commanding sections should frequently halt to see that their carriages are well up, and marching in proper order.

When an accident happens to a carriage, it should, if possible, be drawn out of the column, so as not to interrupt the march of the other carriages or troops. The carriages in its rear must pass it by the most convenient flank, and close to proper distance. The disabled carriage resumes its position as soon as the damage is repaired; when the road is narrow, it must fall into the first interval it finds, and use every opportunity afforded by a wider space to regain its proper place.

A caisson belonging to a disabled piece must remain with it; a piece, however, should not remain with its disabled caisson, but merely leave a sufficient number of men to repair it.

When it is necessary to move a carriage along a slope, where a small jerk may overturn it, a drag rope should

be fastened to the lowest side of the carriage, passed over the top of it, and held by two or three men, marching on the upper side of the slope: a small effort by these means will prevent a carriage from overturning on a very steep slope.

Whenever the ruts are very deep, the carriages must quarter the road; when however the road is narrow and sunk between banks, the horses should be left to themselves and not hurried. In such circumstances a skilful driver will save his horses much, particularly the wheel horses.

In passing over deep furrows, or small ditches or drains, the carriages should cross them obliquely; when they are crossed perpendicularly, the horses not only encounter greater difficulty, but they, as well as the harness, suffer much from the jerks. The former line of march should be resumed as soon as they are passed.

When the roads are good or even tolerable, the artillery is always obliged to wait for infantry, which is attended with much additional fatigue to the horses, from having the harness so much longer upon them. When, therefore, there is no danger, the artillery should be allowed to regulate its own rate of marching.

On ordinary marches the detachments may be in front, rear, right, or left of their respective pieces; or they may all be in front or rear of the column of carriages, as the circumstances may require. But when the detachments are thus separated from their carriages, one man should march with each.

ASCENTS.

If the ascent be long and steep, the road in a bad state, or, if from any other cause, the exertion of the horses is likely to be great, a part of the carriages should halt, the leaders of them be hitched on to those in front, and, when they arrive at the top, be sent back with as many more leaders as may be necessary.

Whatever may be the difficulties of the road, not more than ten horses can be hitched with effect to the

same carriage; beyond this number, and even with it, it is difficult to make the horses pull together.

It may be sometimes necessary to make the detachments assist with bricoles or drag-ropes.

After going up a short steep hill the horses should be halted; but when that cannot be done, they should be made to move slowly to allow them to recover their wind.

In going up a hill, carriages may be halted to rest the horses by bringing them across it, and locking the limbers or chocking the wheels. For this purpose it may be advisable to divide the carriages into portions of three or four each, starting them from the bottom in succession, with an interval of twenty or thirty yards, or more, between each portion.

DESCENTS.

The drivers should never dismount in going down hill. The wheel driver holds his near horse well in hand, and his off horse very short; the other drivers barely stretch their traces.

In descending steep hills the cannoneers must hold on. For this purpose, previous to marching off, the end of a drag-rope is passed twice round the tulip of the piece, and the running part passed into the hook and pulled tight; the rope is then wound round the muzzle, or formed into a small coil and hung on it.

At the caisson the drag-rope is fastened to one of the hind irons, or to the hind axletree. With a light battery, holding on will generally be sufficient; but, if necessary, the wheels must also be locked.

In steep and difficult descents the wheel horses only are left in the carriage, the others being taken out and led in rear; the cannoneers hold on with drag-ropes.

When it is necessary to lock, the middle driver, or with four horses the leading one, dismounts for that purpose. Should there be a ditch, or other dangerous part on the side of the road, the wheel towards that side is locked in preference to the other.

TO CROSS SWAMPY GROUND.

Each carriage should preserve a distance of ten or twelve yards from its file leader, to prevent its being halted. An officer or non-commissioned officer should be posted where the ground presents the greatest difficulty, to instruct the drivers how to conduct their teams. The horses must be made to draw freely and quicken the gait. If the ground is very miry it may be necessary to assist with drag-ropes, or even to use them alone, crossing the teams separately.

TO PASS A DITCH.

The prolonge must be fixed and the handspike taken out. If the ditch be a difficult one the horses are halted at the edge of it, and the piece is run by hand close to the limber, which then proceeds gently until the piece is at the bottom of the ditch, when it moves quickly until the piece is out. Should the ditch be narrow it may be necessary to cut down the edges and hold on with drag-ropes. If in passing over the trail sinks into the ground, it must be disengaged by a drag-rope fixed to it, or by the handspike.

CROSSING FORDS.

When the water is deep and the current strong, great attention must be paid in fording. The person conducting a column over a direct ford, should keep his eyes steadily fixed on some object on the opposite bank, which marks the place of going out. He must not look at the stream, which would deceive him by appearing to carry him down.

All those in rear should keep their eyes on those in front.

In order to resist the power of the stream, it is necessary to wade rather against it.

When the bottom of the ford, or the bank on the opposite side is bad, the leaders of the rear carriages should be hitched to those in front, and an officer stationed at the entrance, and another at the place of going

out. The former causes the distances to be observed, and directs the drivers as to the manner of crossing the ford, and the latter directs them in their leaving it.

The management of the horses and the regulation of their gaits, are the same as prescribed for crossing swampy ground. Above all things, the horses must not be allowed to drink, halt, or trot either in passing the ford or in leaving it. If, however, the stream to be forded is small, and neither deep nor rapid, and there are no troops immediately in rear, this opportunity of watering the horses, or, at least, of giving them a mouthful of water may be embraced.

The passage should be effected with as large a front as possible. After reaching the opposite bank, the leading carriages should move on to such distance from the ford as not to impede those in rear.

If the ford is not well known, it must be examined, and the dangerous places well marked, before the carriages attempt to cross.

Artillery *carriages* can pass a ford three feet and one third deep; and this depth may be attempted when the ammunition boxes are perfectly water tight, or means have been taken to raise them sufficiently high; although much depends upon the bottom and the strength of the current.

When the ammunition boxes are not water tight, and are at their usual height of two feet ten inches above the ground, the depth attempted should not exceed two feet four inches.

PASSAGE OF MILITARY BRIDGES.

At the entrance of the bridge all but the wheel drivers dismount; the dismounted drivers march at their horses' heads, holding the reins of the near horse with the right hand near the bit. A distance of twenty yards is kept between the carriages. The gait must be free and decided, and the drivers should conduct the carriages as near the middle of the flooring as possible; if the flooring is wet, they must attend particularly to

keeping the horses from slipping. Battens should, in this case, be nailed across the bridge. It may sometimes be necessary to pass the carriages and horses separately.

There should be no halt on the bridge. Whenever it is perceived to rock, the passage of the troops must be stopped. If the bridge cracks under a carriage, it should increase its gait and pass as quickly as possible.

In passing over a flying bridge the drivers hold the horses, facing towards them; it may occasionally be advisable to take the horses out; and in boisterous weather, or at night, the wheels should be locked.

REVERSING A BATTERY IN A NARROW ROAD.

All the carriages should be drawn close to one side of the road, and the pieces and caissons unlimbered and reversed. The limbers are then brought in front of their carriages, which are then to be limbered up. If there is not room to reverse the limbers, the horses must be taken out.

Should the road be so narrow that the limbers cannot pass their carriages, the trails of the pieces and stocks of the caissons must be brought into a direction perpendicular to the road; if it has a bank on either side, the wheels must be run close to the bank, and the trails and stocks made to rest upon it. On a dyke, or road with a ditch on each side, the carriages must be run as close to the edge as possible, and the trails and stocks held up while the limbers pass. Great care must be taken not to run the carriages too far, and the wheels must be scotched or locked at the edge of the dyke or ditch.

IN ACTION, OR PREPARING FOR ACTION.

In those formations in battery in which the pieces or sections are brought up successively on the right for ACTION FRONT, each piece should reserve its fire until the one on its right is unlimbered, and its limber reversed: by not attending to this, the horses become so

frightened, as not to be brought up to the piece without difficulty.

No positive rule can be laid down with respect to the caissons in presence of an enemy. This must depend upon a variety of circumstances; but, in general, it will be found expedient to place them under charge of an officer, who will conform to the movements of the main body, in such a manner, and at such distance, as to enable him to supply the pieces with ammunition before that which is in the limbers is expended.

In a hilly road, when any obstruction is expected from the enemy, the leading gun should always be twenty-five or thirty yards in advance of the others, in order to leave room for the limber to take its place in rear when it comes into action, without the necessity of running back the rest of the column. This might be avoided in some cases, by running the piece forward, but cases may arise where it would not be advisable to do so.

When pieces are in position on the brow of a hill, they should be retired from it as far as they can be without losing the command, in order that the men may be covered as much as possible. If it is necessary to place them close to the edge, it should not be done until the firing is about to commence.

Should a battery be ordered to come into action to a flank upon a dyke, or road which is entirely open with a ditch on each side of it, the carriages must take double distance from each other, and the caissons turn so as to bring their rear towards the enemy. When the piece is unlimbered, the limber moves near the caisson and turns its rear also towards the enemy. If the road is too narrow to allow the caissons to change their direction, they remain in the same line with the pieces, and in the middle of the interval between two of them; the limbers do not reverse but move forward to the caisson of the preceding piece.

When pieces are placed on the edge of a considerable slope, they may be run down by hand, the limbers backing so far as to allow the pieces, when the prolonges are stretched, to fire with effect and command the whole

slope. The pieces should, however, be only run down sufficiently to effect this purpose, that the limbers may be as far as possible from the edge, and consequently in some degree covered. Should there be any thing at hand, the wheels may be scotched; or if there is time a small cut may be made across the hill. By these precautions pieces may be fired down a slope so considerable, that they would otherwise run down themselves.

Should there be any fear of a piece running forward, when unlimbered for action on the brow of a hill, the wheel should be locked with the lock chain, prolonge, or drag-rope. It must be applied to the top fellow, or spoke of the wheel, instead of the lower one.

In passing a defile or bridge with the enemy on the other side, and likely to oppose the advance, the pieces alone should move forward, leaving the caissons to follow in rear by themselves.

In retiring through a defile, or over a bridge in the presence of an enemy, the caissons should be sent to the rear; one or two may be kept nearer than the others for supplying ammunition.

The prolonge should be generally used when artillery is retiring slowly. When the rear of the column retires with the prolonge along a road, cavalry will hesitate to attack it, if its flank be secure.

REPLACING KILLED OR DISABLED HORSES.

The teams of the pieces must always be kept complete at the expense of those of the caissons. A disabled horse, in the first instance, is replaced by the corresponding one at the caisson, leaving the caisson to refit with a spare horse and the harness of the disabled one. After all the spare horses have been used, those of the caissons should be taken in succession so that they may be gradually and regularly reduced.

INSTRUCTION FOR THE PRESERVATION OF HARNESS.

The preservation of harness requires two kinds of attention; one, that of neatness, which must be conti-

nual; the other, strictly that of preservation, which consists in oiling the leather parts two or three times a year.

To keep the harness neat, the men should wipe and carefully clean the harness whenever it has been used.

Collars, which it is important to keep soft and supple, must be carefully attended to.

Airing and beating with a rope or small mallet, the stuffing of the collars and saddles, is an important duty, which must not be omitted on continued marches.

In giving the second kind of attention to harness, that of preservation, the oiling should be done oftener in summer than in winter.

The best oil for this use, is neat's foot oil, the unctuous property of which is particularly suitable for preserving the suppleness of the leather. This oil contains no siccative part and may be used unpurified. As a maximum four pints and a half will answer, each time, for oiling the harness of a team of six horses.

Before using the oil, every part of the leather must be perfectly cleaned and washed; without, however, allowing the water to penetrate deeply into the leather. While still damp, blacken those places which have become red, with hatter's dye, ink ball, or acetate of iron; and when the leather begins to dry, oil it, spreading the oil on with a sponge, or thick and soft brush. When neat's foot oil cannot be obtained, fish oil, if pure, may be used. This is very good for preserving black leathers; but it must be carefully ascertained not to contain any siccative matter, as that would render it injurious.

Other oils may be usefully employed, as whale oil, when they can be obtained pure; this is not easily done, and it is difficult to detect the fraud.

Vegetable oils are very injurious.

On campaigns, good oils can rarely be procured; under these circumstances a mixture of three quarters of melted lard and one quarter of whale oil may be used: it should be spread over the leather with a piece of woollen cloth and rubbed in well.

INTERIOR MANAGEMENT OF A BATTERY.

The preservation of horses is an important duty of an artillery officer.

The greatest care should be given to the fitting of the saddles and collars.

Sore backs and galled shoulders arise chiefly from neglect on the march. By prompt attention on the part of the officers, many horses may be preserved for service which would otherwise be disabled for months. The drivers must never be suffered to lounge or sit uneven on their saddles. A folded blanket under the saddle, is the best preventive of sore backs, as it adapts the shape of the saddle to any loss of flesh in the horse.

Every driver should have attached to his harness a pair of pads of soft leather, about six inches by four, stuffed with hair: basil leather is the best for this purpose.

The moment any tenderness is perceived in a horse's shoulder, the pressure must be removed by placing the pads under the collar above and below the tender part.

When a battery arrives in camp, quarters, or a cantonment, each non-commissioned officer will immediately examine every part of the carriage under his charge, especially the wheels, to the greasing of which he must attend: he will report to the officer of his section, who reports to the commander of the battery. All damages must be repaired without delay.

The best grease for wheels is coarse sweet oil and tallow (in equal parts melted together); next to that old soft lard. When these cannot be procured slush may be used. Black lead should be mixed with the grease.

The drivers must immediately report to the non-commissioned officers of their carriages any loss or breakage of their harness, and also any gall or other hurt which may have happened to their horses; - any neglect on this point must be punished. In camp, greasy heels are the most common disability with which horses are affected: as these proceed from cold, occasioning humours to settle, the best preventive is hand rubbing and exercise to keep up a circulation.

Unless for some particular purpose, the elevating screws should never be raised higher than half their length: on a march they must be covered with a piece of canvass, or old flannel cartridge bag, to prevent their being clogged with dirt.

The pintle hooks and lunettes should be greased previous to marching.

If a battery is parked in hot weather, the naves of the wheels must be protected as much as possible from the effect of the sun, by sods, tarpaulings, or other covering.

When a battery is in stationary quarters, there must be a weekly inspection of every part of it, and, when circumstances permit, a parade in marching order; at which parade every part of the harness and appointments of the cannoneers is expected to be in the best order. Particular attention should be given to the state of the ammunition which must be frequently aired.

No fresh ammunition should ever be received without being gauged to the pieces.

After firing on drill or in an action, the bore of the piece should be washed, and the piece depressed.

Buckets must be provided for watering horses on a march. They should be of leather.

BUGLE SIGNALS.

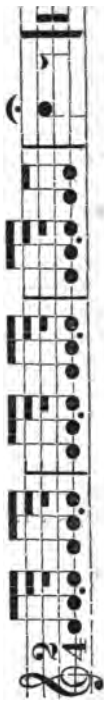
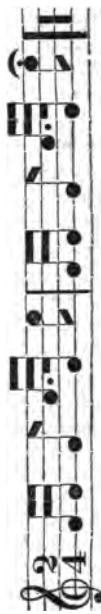
No. 1. *March.*No. 2. *Walk.* . . .No. 3. *Trot.* . . .No. 4. *Gallop.* . . .

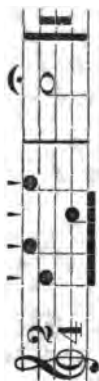

No. 10. *Head of column
to the right.*

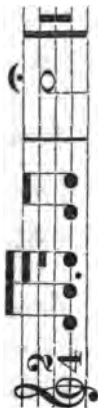

No. 11. *Head of column
to the left.*



No. 12. *About.*



No. 13. *Countermarch.*

